

Bridge Design Memorandums

Table of Contents 1

As of June 16, 2022

YEAR	MEMO	PDF_FILE	DESCRIPTION
2006	DM0106	DM200601.PDF	SCDOT Bridge Design Manual
2006	DM0206	DM200602.PDF	End Bent/End Wall Reinforcing Steel
2006	DM0306	DM200603.PDF	Design Manual Errata: Section Properties for Prestressed Concrete Beams
2007	DM0107	DM200701.PDF	Drilled Shaft Reinforcing Steel
2007	DM0207	DM200702.PDF	Processing Shop Plans
2007	DM0307	DM200703.PDF	CSX Transportation Criteria for Overhead Bridges
2007	DM0407	DM200704.PDF	Review of Structural Plans and Reports by Preconstruction Support
2008	DM0108	DM200801.PDF	Design of Prestressed Concrete Girders
2008	DM0208	DM200802.PDF	Revised Bridge Title Sheets
2008	DM0308	DM200803.PDF	Revised Prestressed Concrete Cored Slab Drawings
2008	DM0408	DM200804.PDF	Adhesively Bonded Anchors and Dowels
2008	DM0508	DM200805.PDF	SCDOT Geotechnical Design Manual and Updated SCDOT Seismic Design Specifications of Highway Bridges
2008	DM0608	DM200806.PDF	SCDOT Seismic Design Specifications for Highway Bridges, Version 2.0 Corrections to Equations 9-1 and 9-2
2009	DM0109	DM200901.PDF	Exceptions to SCDOT Structural Design Criteria
2009	DM0209	DM200902.PDF	Steel H-Pile Anchorage Detail - Figure 19.2-2 of the SCDOT Bridge Design Manual
2009	DM0309	DM200903.PDF	Guardrail-To-Bridge-Rail Transitions - Section 17.6.1.3 of the SCDOT Bridge Design Manual
2009	DM0409	DM200904.PDF	SCDOT Americans with Disabilities Act Transition Plan
2009	DM0509	DM200905.PDF	Section 17.6.1.5 of the SCDOT Bridge Design Manual
2010	DM0110	DM201001.PDF	Section 11.3.9 of the SCDOT Bridge Design Manual
2010	DM0210	DM201002.PDF	SCDOT Geotechnical Design Manual - Version 1.1
2010	DM0310	DM201003.PDF	SCDOT Geotechnical Design Manual, Version 1.1 - Revisions to Chapter 9, Chapter 16, and Appendix A
2010	DM0410	DM201004.PDF	SCDOT Bridge Design Manual - Revisions to Chapter 6
2010	DM0510	DM201005.PDF	SCDOT Geotechnical Design Manual, Version 1.1 - Revisions to Chapter 21
			Drilled Shafts - Revisions to Sections 12.5.3.2, 15.3.1.2, 19.3.3, and 20.3.2.1 of the SCDOT Bridge Design Manual and Sections 16.4 and 22.2.1.2 of the SCDOT
2011	DM0111	DM201101.PDF	Geotechnical Design Manual
2011	DM0211	DM201102.PDF	SCDOT Geotechnical Design Manual, Version 1.1 - Revisions to Chapters 4, 8, 9, 10, and 17
2011	DM0311	DM201103.PDF	Diaphragms for Prestressed Concrete Beams - Revisions to Sections 15.5.7 and 17.3.6 of the SCDOT Bridge Design Manual
2012	DM0112	DM201201.PDF	Mechanically Stabilized Earth (MSE) Walls
2012	DM0212	DM201202.PDF	SCDOT Bridge Design Manual - Revisions to Sections 21.2.1.8 and 21.2.1.9
2012	DM0312	DM201203.PDF	Prestressed Concrete Pile Connection Details - Revisions to Section 19.2.6.3, Section 20.1.2, Figure 20.1-1, and Section 20.2.7.1 of the SCDOT Bridge Design Manual
2013	DM0113	DM201301.PDF	Bicycle Rail Height - Revision to Section 17.6.3 of the South Carolina Bridge Design Manual
2013	DM0213	DM201302.PDF	Vehicular Collision Force and Bent Protection - Section 13.3.2.7 of the SCDOT Bridge Design Manual
2014	DM0114	DM201401.PDF	Jointless Bridges - Sections 12.2.4.1, 12.2.8, 12.4.2.2, 12.4.2.5, 12.7.8, 17.4.2, 20.2.7.2, 21.1.1.1, and 21.1.1.10 and Figure 21.1-1 of the SCDOT Bridge Design Manual
2014	DM0214	DM201402.PDF	Revised Labeling of Bridge Plans
2014	DM0314	DM201403.PDF	Construction Joint Requirements
2015	DM0115	DM201501.PDF	SCDOT Seismic Design Specifications for Highway Bridges, Version 2.0 - Revisions to Section 3, Section 6, Section 7, Section 8 and Section 9
2020	DM0120	DM202001.PDF	Roadway Widths and Geometric Layout of Prestressed Concrete Cored Slab Bridges
2020	DM0220	DM0220.PDF	Revision to SCDOT Bridge Design Manual
			Reinforcing Steel Development Lengths for Bars in Tension and Reinforcing Steel Splice Lengths for Bars in Tension - Revisions to Figures 15.3-4, 15.3-5, and 15.3-6 and
2020	DM0320	DM0320.PDF	Sections 15.3.1.6 and 15.3.1.7 of the SCDOT Bridge Design Manual
2020	DM0420	DM0420.PDF	Providing Asset IDs for Bridges and Roadway Structures
2020	DM0520	DM0520.PDF	Neglecting the Effect of Elastic Gains in the Design of Prestressed Concrete Girders
2022	DM0122	DM0122.PDF	Seismic Design Summary Reports for New Bridges
2022	DM0222	DM0222.PDF	Revisions to Requirements for Providing Top of Slab Elevations Sheet in Bridge Plans



South Carolina  
Department of Transportation

DM0106

June 7, 2006

**MEMORANDUM TO TEAM LEADERS AND CONSULTANTS**

**SUBJECT:**        *SCDOT Bridge Design Manual*

---

Effective July 1, 2006, all new bridge designs shall comply with the requirements of the *SCDOT Bridge Design Manual*. Projects currently in the design phase should also comply with the requirements of the *Manual*, unless the design and detailing are substantially complete. Bridge Design Memorandums dated prior to April 2006 will not apply to projects being designed using the criteria of the *Manual*.

The *Manual* may be viewed or downloaded from the Department's website at [www.scdot.org/doing](http://www.scdot.org/doing). Copies may also be obtained, at a cost of \$75.00 per manual, through the Department's Engineering Publications Office at (803) 737-4533 or at [engrpubsales@dot.state.sc.us](mailto:engrpubsales@dot.state.sc.us).

As the need arises, Bridge Design Memorandums will be issued to supplement or revise the requirements of the *Manual*. These memorandums will supersede the contents of the *Manual* and will be posted on the Department's website.

Mitchell D. Metts, P.E.  
Bridge Design Engineer

cc: Assistant Bridge Design Engineers  
Bridge Construction Engineer  
Bridge Maintenance Engineer  
FHWA Structural Engineer

File: PC/BWB





October 17, 2006

**MEMORANDUM TO TEAM LEADERS AND CONSULTANTS**

**SUBJECT:** End Bent/End Wall Reinforcing Steel

---

Prior to the pouring of the end wall concrete, the ends of straight reinforcing steel, projecting vertically from the end bent cap, present an impalement hazard to workers. To eliminate the hazard, the Contractor must use protective devices to cover the ends of the bars. Therefore, whenever it is practical to do so, detail a standard 180 degree hook at the end of the projecting reinforcing steel. See the attached example showing this preferred detail.

The requirements of this memorandum are considered to be a supplement to the requirements of the *SCDOT Bridge Design Manual*. The *Manual* will be updated at a later date to reflect these requirements.

Mitchell D. Metts, P.E.  
Bridge Design Engineer

Attachment

cc: Assistant Bridge Design Engineers  
Bridge Construction Engineer  
Bridge Maintenance Engineer  
FHWA Structural Engineer

File: PC/BWB



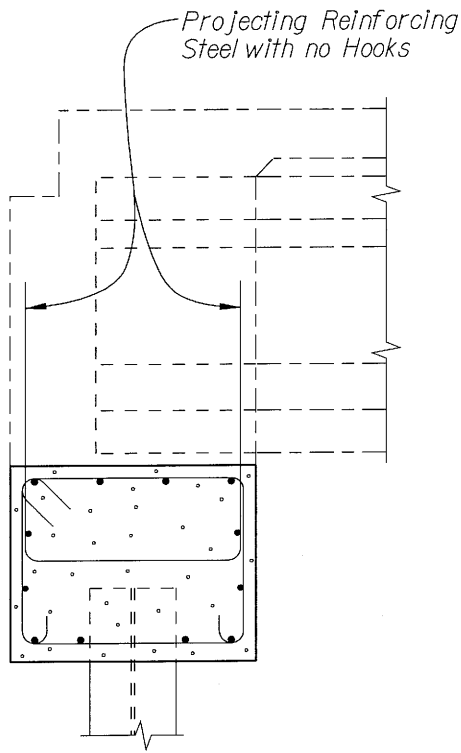

DETAIL WITH STRAIGHT  
REINFORCING STEEL

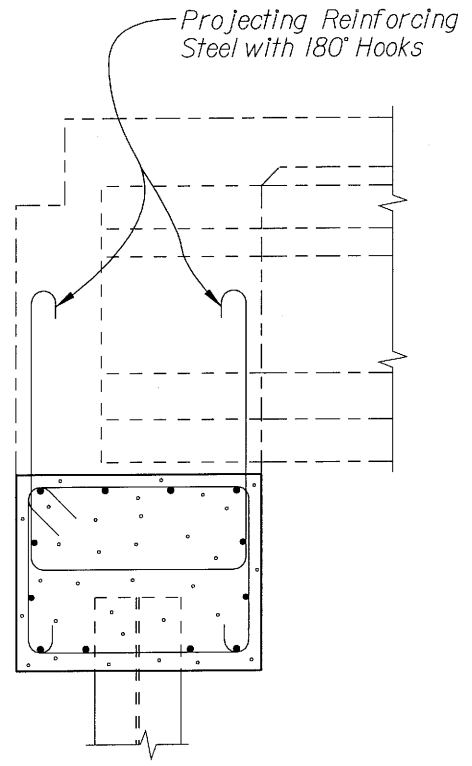

PREFERRED DETAIL  
WITH HOOKS

## SECTION THRU END BENT CAP

*Note:*  
Reinforcing steel arrangement is shown to illustrate the use of the 180° hooks only. Reinforcing steel details will vary depending on items such as end wall dimensions, girder size, girder type, and loading requirements.



November 14, 2006

**MEMORANDUM TO TEAM LEADERS AND CONSULTANTS**

**SUBJECT:** Design Manual Errata  
Section Properties for Prestressed Concrete Beams

---

Figure 15.5-1 (on pages 15-30 and 15-31) of the *SCDOT Bridge Design Manual* shows dimensions and section properties for prestressed concrete beams. The section properties for the Type I Modified Beam and the 54" Modified Bulb-Tee Beam are not correct. The correct values are indicated below:

Type I Modified Beam

$$I = 26,495 \text{ in}^4$$

54" Modified Bulb-Tee

$$A = 707 \text{ in}^2$$

$$W = 737 \text{ plf}$$

$$Y_{\text{TOP}} = 26.21''$$

$$Y_{\text{BOT}} = 27.79''$$

$$I = 277,560 \text{ in}^4$$

Please make the appropriate corrections to your copy of the *Manual*.

Mitchell D. Metts, P.E.  
Bridge Design Engineer

cc: Assistant Bridge Design Engineers  
Bridge Construction Engineer  
Bridge Maintenance Engineer  
FHWA Structural Engineer

File: PC/BWB





February 9, 2007

**MEMORANDUM TO TEAM LEADERS AND CONSULTANTS**

**SUBJECT:** Drilled Shaft Reinforcing Steel

---

The existing requirements of Section 15.3.1.3.2 of the *SCDOT Bridge Design Manual* shall be replaced with the following:

For both parallel longitudinal reinforcing bars and parallel transverse reinforcing bars, the clear distance between bars shall not be less than five times the maximum aggregate size or 5 inches. When bundled bars are used, consideration shall be given to increasing these minimum clear spacing requirements.

Please note this revision in your copy of the *Manual*.

Mitchell D. Metts, P.E.  
Bridge Design Engineer

cc: Assistant Bridge Design Engineers  
Bridge Construction Engineer  
Bridge Maintenance Engineer  
FHWA Structural Engineer

File: PC/BWB





South Carolina  
Department of Transportation

**BRIDGE DESIGN MEMORANDUM – DM0207**

**TO:** RPG Structural Engineers  
Structural Design Consultants

**DATE:** September 28, 2007

**RE:** Processing Shop Plans

Due to the reorganization of the Preconstruction Division, the Department has revised its internal process for handling shop plans. The attached flowcharts show the detailed steps of the Department's new shop plan review process.

Items 1 and 2 in Section 24.1.2 of the *SCDOT Bridge Design Manual* shall be deleted and replaced with Items 1 and 2 shown below:

1. **Shop Plans (In-House Designed Projects)** The Contractor submits seven sets of the shop plans to the SCDOT Preconstruction Support Engineer. The Logistics Coordinator of the Preconstruction Support Group forwards the plans to the appropriate Regional Production Group for review. After review, the Regional Production Group returns six sets of the shop plans to the Logistics Coordinator. The Logistics Coordinator retains one set of the shop plans for the file and distributes:
  - one set to the Contractor,
  - two sets to the SCDOT Resident Construction Engineer, and
  - two sets to the SCDOT Materials and Research Engineer.
  
2. **Shop Plans (Consultant Designed Projects)** The Contractor submits seven sets of the shop plans directly to the Consultant. After the Consultant reviews the shop plans, the Consultant submits six sets of the shop plans to the SCDOT Preconstruction Support Engineer, not the Contractor. The Logistics Coordinator of the Preconstruction Support Group forwards the plans to the appropriate Regional Production Group for review. After review, the Regional Production Group returns six sets of the shop plans to the Logistics Coordinator. The Logistics Coordinator retains one set of the shop plans for the file and distributes:
  - one set to the Contractor,
  - two sets to the SCDOT Resident Construction Engineer, and
  - two sets to the SCDOT Materials and Research Engineer.



Shop plan submittals to the Department should be forwarded to the following address:

South Carolina Department of Transportation  
Preconstruction Support Engineer  
955 Park Street - Room 409  
Columbia, South Carolina 29201  
Attention: Logistics Coordinator



Barry W. Bowers  
Structural Design Support Engineer

Attachments

cc: Bridge Construction Engineer  
Bridge Maintenance Engineer  
FHWA Structural Engineer  
Preconstruction Support Engineer  
Regional Production Engineers  
RPG Design Managers

File: PC/BWB



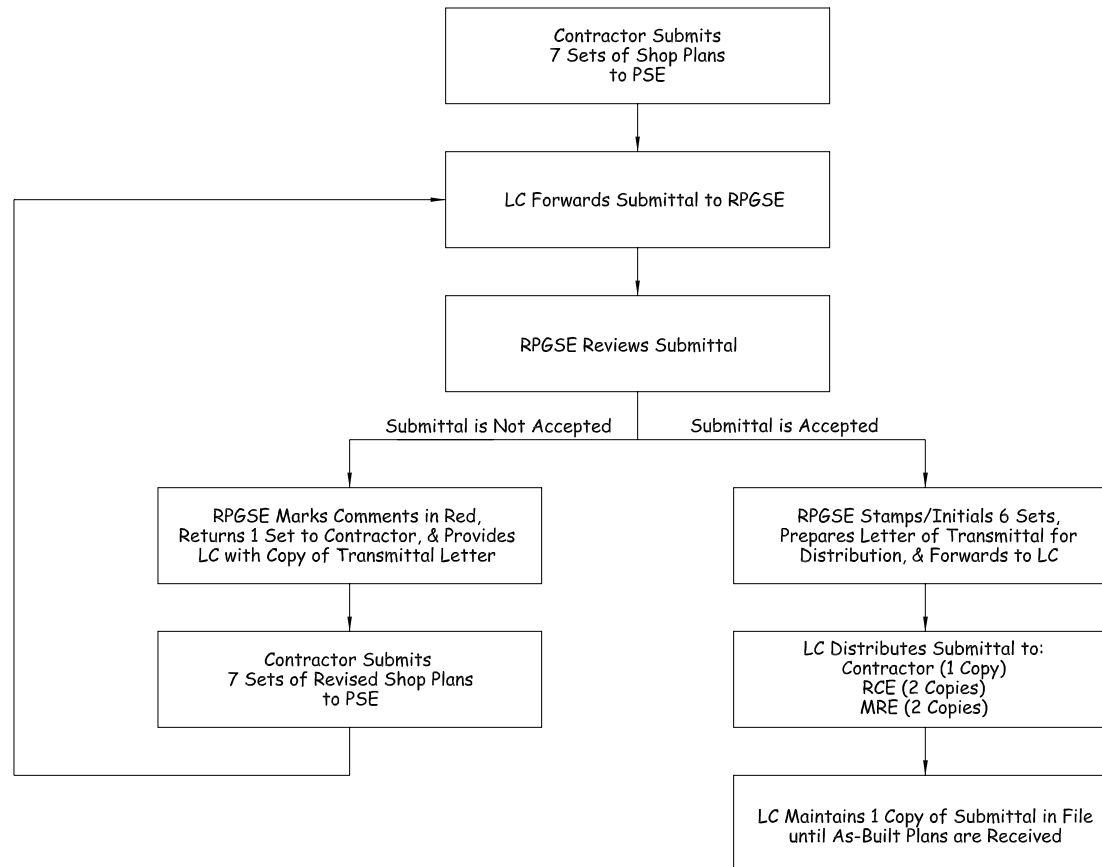

## FLOWCHART FOR PROCESSING SHOP PLANS IN-HOUSE DESIGNED PROJECTS

**LEGEND:**

LC - Logistics Coordinator - Preconstruction Support Group  
 MRE - Materials and Research Engineer  
 PSE - Preconstruction Support Engineer  
 RCE - Resident Construction Engineer  
 RPGSE - Regional Production Group Structural Engineer

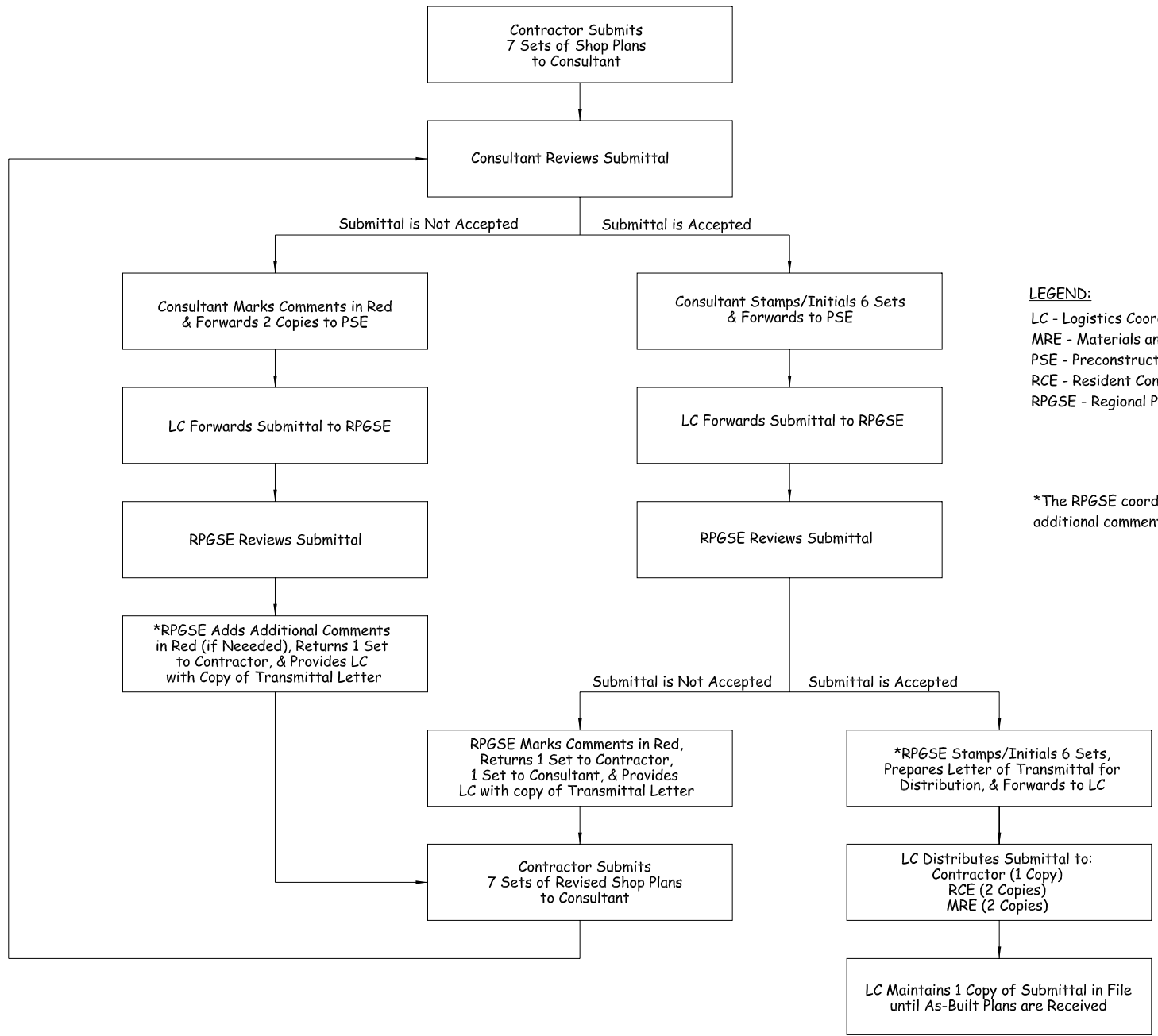

**LEGEND:**

- LC - Logistics Coordinator - Preconstruction Support Group
- MRE - Materials and Research Engineer
- PSE - Preconstruction Support Engineer
- RCE - Resident Construction Engineer
- RPGSE - Regional Production Group Structural Engineer

\*The RPGSE coordinates with the Consultant if additional comments are added.

## FLOWCHART FOR PROCESSING SHOP PLANS CONSULTANT DESIGNED PROJECTS



South Carolina  
Department of Transportation

**BRIDGE DESIGN MEMORANDUM – DM0307**

**TO:** RPG Structural Engineers  
Structural Design Consultants

**DATE:** September 28, 2007

**RE:** CSX Transportation Criteria for Overhead Bridges

As indicated in Sections 22.2.1 and 22.2.4 of the *SCDOT Bridge Design Manual*, the Department considers the criteria established by the individual railroad companies when designing highway bridges over railroads. The attached CSX Transportation (CSXT) "Criteria for Overhead Bridges," dated September 14, 2007, shall be used when preparing designs for projects that involve bridge work over CSXT's railroad tracks.

Where there are conflicts with the CSXT criteria and the requirements of the *Manual*, the more conservative requirement shall be used for design. For projects where designs are complete or are substantially complete and where the designs do not fully comply with all of the revised CSXT requirements, the designer will coordinate with the Department's Railroad Projects Manager to determine if revisions are needed.

Barry W. Bowers  
Structural Design Support Engineer

Attachment

cc: Bridge Construction Engineer  
Bridge Maintenance Engineer  
FHWA Structural Engineer  
Preconstruction Support Engineer  
Railroad Projects Manager  
Regional Production Engineers  
RPG Design Managers  
Rights of Way Administrator

File: PC/BWB



**CSX TRANSPORTATION**

**CRITERIA FOR OVERHEAD BRIDGES**

Office of Director Fixed Plant Engineering  
Jacksonville, Florida  
Date Issued: September 14, 2007

---

**CRITERIA FOR OVERHEAD BRIDGES**

CSX Transportation (CSXT) has minimum requirements for outside parties constructing, rehabilitating, or replacing bridges over CSXT's railroad tracks. These requirements are intended to provide safe and continuous passage of all train traffic during and after construction of bridges over its tracks. Part of these requirements is for the outside party to submit a detailed plan of the project as well as provide details of the construction methodology. This document provides information on the requirements by CSXT for overhead bridges.

Plans and specifications for new or reconstructed bridges over CSXT's railroad tracks or right-of-way shall meet the following requirements:

**I. GENERAL REQUIREMENTS:**

- A. CSXT's valuation station and the distance from the nearest milepost at the intersection of the centerline of the track and the centerline of the bridge shall be shown on the General Plan.
- B. The existing and proposed minimum horizontal and vertical clearances shall be marked clearly on the General Plan and Elevation.
- C. At least one subsurface exploration boring for each substructure unit adjacent to the track shall be furnished to CSXT's during the design submittal. Borings shall provide enough information to design shoring and foundations.
- D. Prior to construction activities, all overhead bridge projects will require the procurement of the appropriate property rights from CSX Real Property and other construction agreement(s) with CSX Transportation.
- E. All lifting equipment and connection devices shall have capacity for 150% of the actual lifting load. The factor of safety provided by the manufacturer in the lifting capacity data shall not be considered in the 150% requirement. A licensed professional engineer, familiar with lifting and rigging, in the State where the construction work is proposed must sign and seal all plans and calculations related to critical lifting on the project.

**II. CLEARANCES:**

- A. **Horizontal Clearance:** Standard horizontal clearance from centerline of the track to the face of the pier or abutment shall typically be 25'-0" or greater, but never less than 18'-0", measured perpendicular to the track. Provisions for future tracks, access roads, other CSXT facilities, and drainage may require the minimum clearance be increased or use of multi-span structures. The toe of footings shall not be closer than 11'-0" from centerline of the track to provide adequate room for sheeting.

- B. Vertical Clearance: A standard vertical clearance of 23'-0" shall be provided, measured from top of high rail to lowest point of structure in the horizontal clearance area which extends 6'-0" either side of the centerline of track.
- C. Temporary Construction clearances to be used shall be subject to approval by CSXT. Typically reductions in clearance for construction are not permitted.
- D. CSXT shall be furnished as-built drawings showing actual clearances as constructed.

### III. CRASHWALLS:

AREMA Specifications, Chapter 8, Article 2.1.5 covers the requirements for crashwalls. Crashwalls are required when face of the pier is closer than 25'-0" from centerline of the track, measured perpendicular to the track, except as noted below.

Crashwalls shall meet the following requirements:

- A. Crashwalls for single column piers shall be minimum 2'-6" thick and shall extend a minimum of 6'-0" above the top of high rail for piers located between 18'-0" and 25'-0" from the centerline of the nearest track. The wall shall extend minimum 6'-0" beyond the column on each side in the direction parallel to the track.
- B. For multi-column piers, the columns shall be connected with a wall of the same thickness as the columns or 2'-6" whichever is greater. The wall shall extend a minimum of 2'-6" beyond the end of outside columns in a direction parallel to the track.
- C. Reinforcing steel to adequately anchor the crashwalls to the column and footing shall be provided.

For piers of heavy construction, crashwalls may be omitted. Solid piers with a minimum thickness of 2'-6" and length of 20'-0", single column piers of minimum 4'-0" X 12'-6" dimensions or any other solid pier sections with equivalent cross sections and minimum 2'-6" thickness are considered as heavy construction.

### IV. DRAINAGE:

Drainage from the bridge shall be preferably collected with drain pipes and drained away from CSXT's right-of-way. When open scuppers are provided on the bridge, none shall be closer than 25'-0" of the centerline of nearest track. Flow from the scuppers shall be directed away from CSXT's drainage ditches.

Projects including stormwater systems shall be designed for a 100-year storm event as a minimum. If stormwater is drained on or to CSXT's right-of-way, calculations must be submitted to CSXT to verify the 100-year storm event is properly handled. Improvements to the adjacent drainage systems may be required at project expense, to ensure the impacted system will meet the 100-year storm event minimum condition.

During and after completion of construction, the outside party or its contractor must clear CSXT's drainage ditches of all debris to the satisfaction of CSXT's construction engineering and inspection representative

**V. PROTECTIVE FENCING**

All highway structures shall have a protective barrier fence to extend at least 8'-0" from the top of the sidewalk or driving surface adjacent to the barrier wall. The fence may be placed on top of the barrier wall. The fence shall be capable of preventing pedestrians from dropping debris onto CSXT's right-of-way, and in particular, passing trains. Openings in the fence shall not exceed 2"x2". Fencing should also include anti-climb shields or be of a configuration to minimize the likelihood of climbing on the outside of the protective fencing. A chain link fence option is shown below:

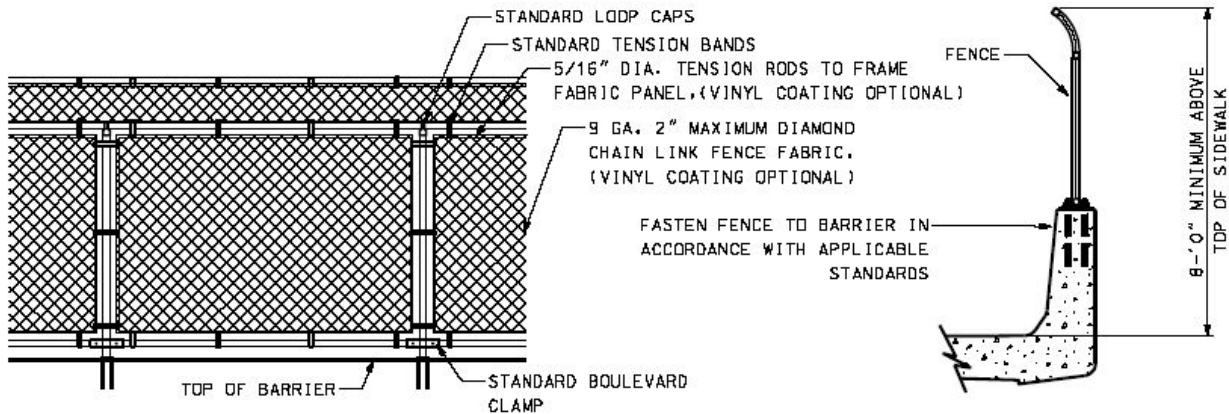

**VI. STRUCTURE EXCAVATION AND SHORING:**

Shoring protection shall be provided when excavating adjacent to an active track. Shoring will be provided in accordance with AREMA *Manual for Railway Engineering* Chapter 8 part 28, except as noted below.

Shoring will not be required if both the following conditions are satisfied:

1. Excavation does not encroach upon a 1 ½ horizontal: 1 vertical theoretical slope line starting 1'-6" below top of rail and at 12'-0" minimum from centerline of the track (live load influence zone).
2. Track is on level ground or in a cut section and on stable soil.

When the track is on an embankment, excavating the toe of the embankment without shoring may affect the stability of the embankment. Therefore, excavation of the embankment toe without shoring will not be permitted.

Preferred protection is the cofferdam type that completely encloses the excavation. Where dictated by conditions, partial cofferdams with open sides away from the track may be used. Cofferdams shall be constructed using steel sheet piling or steel soldier piles with timber lagging. Wales and struts shall be provided as needed. The following shall be considered when designing cofferdams:

- a. Shoring shall be designed to resist a vertical live load surcharge of 1,882 lbs. per square foot, in addition to active earth pressure. The surcharge shall be assumed to act on a continuous strip, 8'-6" wide. Lateral pressures due to surcharge shall be computed using the strip load formula shown in *AREMA Manual for Railway Engineering*, Chapter 8, Part 20.
- b. Allowable stresses in materials shall be in accordance with *AREMA Manual for Railway Engineering*, Chapter 7, 8, and 15.
- c. A construction procedure for temporary shoring shall be shown on the drawing.
- d. Safety railing shall be installed when temporary shoring is within 15'-0" of the centerline of the track.
- e. A minimum distance of 10 feet from centerline of the track to face of nearest point of shoring shall be maintained.

The contractor shall submit the following drawings and calculations for CSXT's review and approval.

1. Three (3) sets of detailed drawings of the shoring systems showing sizes of all structural members, details of connections, and distances from centerline of track to face of shoring. Drawing shall show a section showing height of shoring and track elevation in relation to bottom of excavation.
2. One set of calculations of the shoring design.

The drawings and calculations shall be prepared by a Licensed Professional Engineer in the State where shoring is to be constructed and shall bear his seal and signature. Shoring plans shall be approved by CSXT's construction engineering and inspection representative.



3. For sheeting and shoring within 18'-0" of the centerline of the track, the live load influence zone, and in slopes, the contractor shall use sheet pile. No sheet pile in slopes or within 18'-0" of the centerline of track shall be removed. Sheet piles shall be cut off 3'-0" below the finished ground line. The remaining 3'-0" shall be backfilled and compacted immediately after cut off.

## **VII. DEMOLITION OF EXISTING STRUCTURE:**

The Contractor shall submit a detailed procedure for demolition of existing structures over or adjacent to CSXT's tracks or right-of-way. The procedure shall clearly indicate the capacity of cranes, location of cranes with respect to the tracks and calculated lifting loads (refer to Section I.E of this document). The demolition procedure must be approved by CSXT's construction engineering and inspection representative.

CSXT's tracks, signals, structures, and other facilities shall be protected from damage during demolition of existing structure or replacement of deck slab. As a minimum, both of the following methods shall be used:

- A. During demolition of the deck, a protection shield shall be erected from the underside of the bridge over the track area to catch falling debris. The protection shield shall be supported from girders or beams. The deck shall be removed by cutting it in sections and lifting each section out. The protection shield shall be designed, with supporting calculations, for a minimum of 50 pounds per square foot plus the weight of the equipment, debris, personnel, and other loads to be carried.

Large pieces of deck shall not be allowed to fall on the protection shield

- B. A ballast protection system consisting of geofabric or canvas shall be placed over the track structure to keep the ballast clean. The system shall extend along the track structure for a minimum of 25'-0" beyond the limits of the demolition work, or farther if required by CSXT's construction engineering and inspection representative.
- C. The Contractor shall submit detailed plans, with supporting calculations, of the protection shield and ballast protection systems for approval prior to the start of demolition.
- D. Blasting will not be permitted to demolish a structure over or within CSXT's right-of-way.

**VIII. ERECTION PROCEDURE:**

The Contractor shall submit a detailed procedure for erecting over or adjacent to CSXT's tracks or right-of-way. The procedure shall clearly indicate the capacity of cranes, location of cranes with respect to the tracks and calculated lifting loads (refer to Section I.E of this document). The erection procedure must be approved by CSXT's construction engineering and inspection representative.

**IX. PILE INSTALLATION**

- A. For the installation of piles and sheeting for abutment foundations, pier foundations, retaining wall foundations, temporary and permanent shoring and other structures on or adjacent to CSXT's right-of-way, the contractor may be required to submit a detailed track monitoring program for CSXT's approval prior to performing any work near CSXT's right-of-way.
- B. The program shall specify the survey locations, the distance between the location points, and frequency of monitoring before, during, and after construction. CSXT shall have the capability of modifying the survey locations and monitoring frequency as needed during the project.
- C. If any settlement is observed, CSXT's construction engineering and inspection representative shall be immediately notified. CSXT, at its sole discretion, shall have the right to immediately require all contractor operations to be ceased, have the excavated area immediately backfilled and/or determine what corrective action is required. Any corrective action required by CSXT or performed by CSXT including the monitoring of corrective action of the contractor will be at project expense.

**X. PEDESTRIAN OVERHEAD**

Pedestrian overhead bridges shall be governed by this document in its entirety with the following exceptions:

- A. Pedestrian overhead bridges shall span the entire width of CSXT's right-of-way. Intermediate piers or other supports will not be permitted.
- B. Pedestrian overhead bridges shall be completely enclosed with protective canopy or by other means to prevent users from dropping debris onto CSXT's right-of-way.

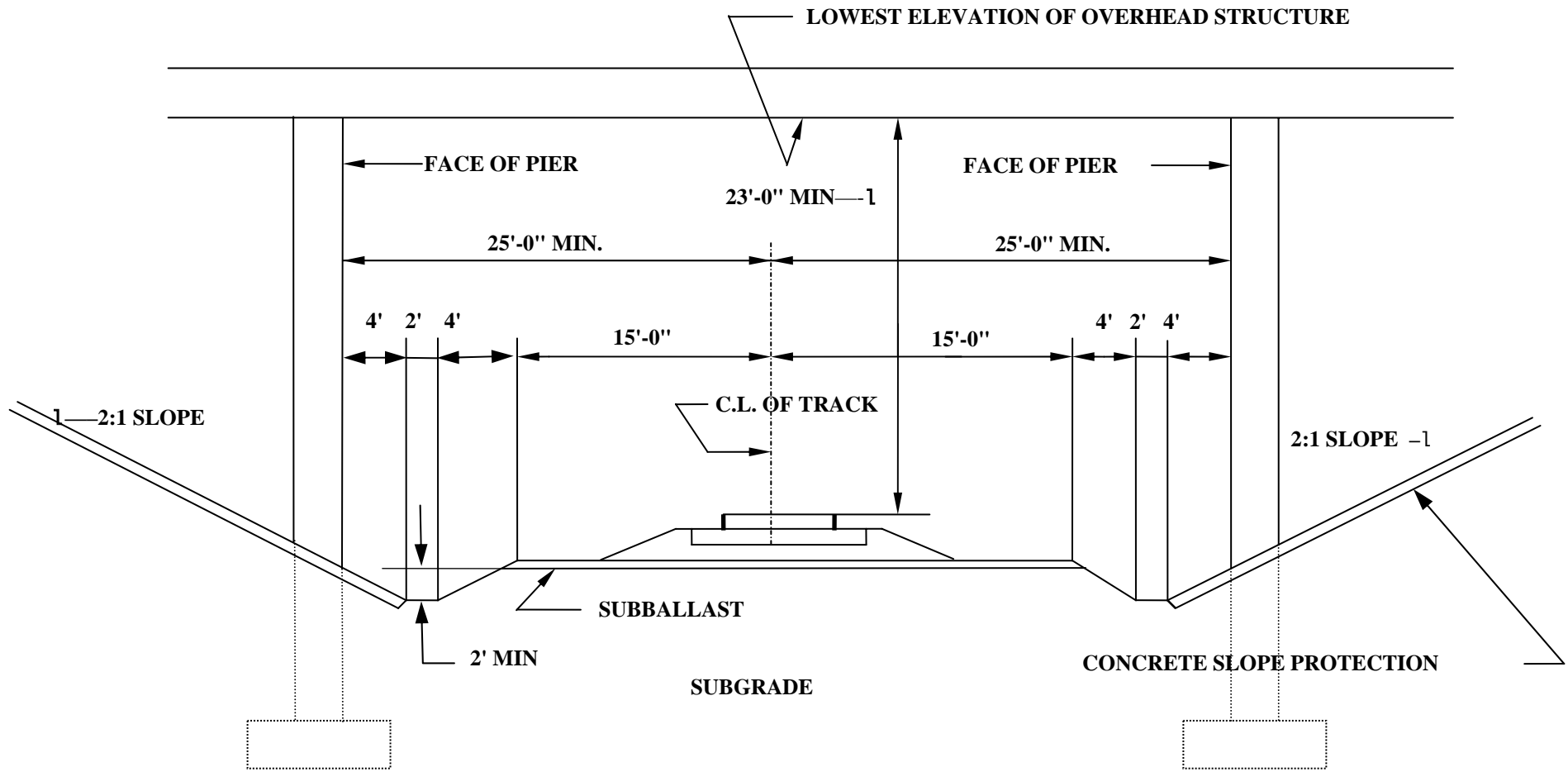

**CLEARANCES REQUIRED FOR OVERHEAD STRUCTURES**  
**TYPICAL ROADBED SECTION WITH STANDARD DITCHES**

**NOTE:** FOR MULTIPLE TRACKS, STANDARD TRACK CENTERS IS 15'-0". AN ADDITIONAL 8'-0" WIDE ACCESS ROAD MAY BE REQUIRED TO PROVIDE 33'-0" MINIMUM DISTANCE FROM CENTERLINE OF TRACK TO FACE OF PIER.

**CSX** ENGINEERING DEPARTMENT

STANDARD CLEARANCES FOR OVERHEAD STRUCTURES





South Carolina  
Department of Transportation

**BRIDGE DESIGN MEMORANDUM – DM0407**

**TO:** RPG Structural Engineers  
Structural Design Consultants

**DATE:** December 20, 2007

**RE:** Review of Structural Plans and Reports by Preconstruction Support

Structural plans and reports developed by the Regional Production Groups (RPG) and their Consultants will be reviewed by the Structural Design Support Group of Preconstruction Support. The RPG should submit the following plans and reports to the Structural Design Support Engineer:

- Conceptual Bridge Plans (when applicable)
- Preliminary Bridge Plans
- 60% Bridge Plans (when applicable)
- 95% Bridge Plans
- Seismic Design Reports (when applicable)
- Preliminary Geotechnical Reports (Road and Bridge)
- Final Geotechnical Reports (Road and Bridge)
- Right of Way Plans for Retaining Walls and Culverts
- Construction Plans for Retaining Wall and Culverts
- Contractor proposed Value Engineering Plans involving Structures or Embankments

The Structural Design Support Group will review the above submittals for application of designs and for consistency with design specifications and Department policies. In-depth reviews, for both in-house and consultant submittals, should be performed by the RPG.

When requested, the Structural Design Support Group will also participate on design review teams in support of RPG design/build projects, participate on Value Engineering teams, review structural plans in response to county sales tax initiatives, review encroachment permits, and provide preliminary scoping reviews for project development and maintenance activities.

At any point during the project development process, designers may request from the Structural Design Support Group technical reviews of details or designs. For project-specific issues, Consultant designers should coordinate with the RPG when making such requests.

E. S. Eargle  
Preconstruction Support Engineer

ESE:bwb  
cc: Bridge Construction Engineer  
Bridge Maintenance Engineer  
FHWA Structural Engineer  
Preconstruction Support Managers  
Regional Production Engineers  
RPG Design Managers



File:PC/ESE

Post Office Box 191  
Columbia, South Carolina 29202-0191

Phone: (803) 737-2314  
TTY: (803) 737-3870

AN EQUAL OPPORTUNITY/  
AFFIRMATIVE ACTION EMPLOYER



South Carolina  
Department of Transportation

**BRIDGE DESIGN MEMORANDUM – DM0108**

**TO:** RPG Structural Engineers  
Structural Design Consultants

**DATE:** January 8, 2008

**RE:** Design of Prestressed Concrete Girders

The first and second paragraphs of Section 15.5.6.1 of the *SCDOT Bridge Design Manual* shall be replaced with the following:

This Section addresses the general design theory and procedure for precast, prestressed (pre-tensioned) concrete girders. Although SCDOT design requirements differ somewhat, design examples can be found in Chapter 9 of the *PCI Bridge Design Manual*.

Where practical, multiple span bridges composed of precast, prestressed concrete girders should be detailed as continuous with continuity diaphragms at interior supports to eliminate expansion joints in the deck slab. When precast, prestressed concrete girders are detailed as continuous for live load and superimposed dead load, the following apply:

- All structural components shall be designed for the more critical condition of either assuming a fully effective connection at the continuity diaphragm (fully continuous span) or assuming complete loss of continuity (simple spans).
- Restraint moments caused by girder creep and shrinkage may be neglected.
- A positive moment connection shall be provided with a factored resistance,  $\phi M_n$ , of not less than  $1.2 M_{cr}$ , as specified in AASHTO LRFD Article 5.14.1.4.9. See the *SCDOT Bridge Drawings and Details* (available at the SCDOT website) for preferred details of positive moment reinforcement in girders.
- The specification of the minimum age of the precast girder when continuity is established is not required.
- The requirements of AASHTO LRFD Articles 5.14.1.4.6, 5.14.1.4.7, and 5.14.1.4.8 shall apply.
- The design of continuity diaphragms at interior supports may be based on the strength of the concrete in the girders when the ends of girders are directly opposite each other across a continuity diaphragm.



Sections 15.5.3.1 and 15.5.3.3 of the *Manual* shall be revised as indicated below:

- a. Section 15.5.3.1 shall be replaced with the following:

Tensile stress limits for fully prestressed concrete members shall conform to the requirements for "Other Than Segmentally Constructed Bridges" in LRFD Article 5.9.4. Projects located in Beaufort, Berkeley, Charleston, Colleton, Dorchester, Georgetown, Horry, and Jasper Counties shall be designed using the stress limits for severe corrosive conditions. Projects located in all other counties shall be designed using the stress limits for moderate corrosion conditions.

- b. The last paragraph of Section 15.5.3.3 shall be replaced with the following:

In analyzing stresses and/or determining the required length of debonding, stresses shall be limited to the values in LRFD Article 5.9.4. Projects located in Beaufort, Berkeley, Charleston, Colleton, Dorchester, Georgetown, Horry, and Jasper Counties shall be designed using the stress limits for severe corrosive conditions. Projects located in all other counties shall be designed using the stress limits for moderate corrosion conditions.

Please note these revisions in your copy of the *Manual*. The *Manual* will be updated at a later date to reflect these requirements.



E. S. Eargle

Preconstruction Support Engineer

cc: Bridge Construction Engineer  
Bridge Maintenance Engineer  
FHWA Structural Engineer  
Preconstruction Support Managers  
Regional Production Engineers  
RPG Design Managers

File: PC/BWB



South Carolina  
Department of Transportation

**BRIDGE DESIGN MEMORANDUM – DM0208**

**TO:** RPG Structural Engineers  
Structural Design Consultants

**DATE:** April 2, 2008

**RE:** Revised Bridge Title Sheets

Attached for your use are copies of revised bridge title sheets for both in-house and Consultant designed projects. Electronic copies of these sheets can be obtained from the *SCDOT Bridge Drawings and Details* at the Department's website.

The revised title sheets include the following changes:

- The signature blocks found on the previous in-house title sheet have been replaced by blocks for the initials of the reviewers. The list of reviewers has been revised to reflect Preconstruction's current organization.
- Blocks for the initials of Department reviewers have been added to the Consultant title sheet.
- An information block has been added to provide the mailing address for shop plan submittals. For Consultant-designed projects, the Consultant will provide contact information for the office that is responsible for review of the shop plans for the project.
- Additional information blocks have been provided outside the sheet borders. These additional information blocks are placed on the title sheets of "fast track" or other similar types of bridge projects where roadway approach plans are incorporated in the bridge plans.

These changes amend the requirements of Section 6.3.1 of the *SCDOT Bridge Design Manual*. The *Manual* will be updated at a later date to reflect the changes.

E. S. Eargle  
Preconstruction Support Engineer

ESE:bwb  
Attachments  
cc: Bridge Construction Engineer  
Bridge Maintenance Engineer  
FHWA Structural Engineer  
Preconstruction Support Managers  
Regional Production Engineers  
RPG Design Managers

File: PC/BWB

Post Office Box 191  
Columbia, South Carolina 29202-0191

Phone: (803) 737-2314  
TTY: (803) 737-3870



AN EQUAL OPPORTUNITY/  
AFFIRMATIVE ACTION EMPLOYER



INDEX OF SHEETS

1. Title Sheet
2. Summary of Estimated Quantities
3. General Notes
4. General Details
5. Reinforcing Bending Details



South Carolina Department of Transportation

PROPOSED PLANS  
FOR

COUNTY  
FILE NO.  
ROUTE  
REPLACE BRIDGE OVER

SITE LOCATION

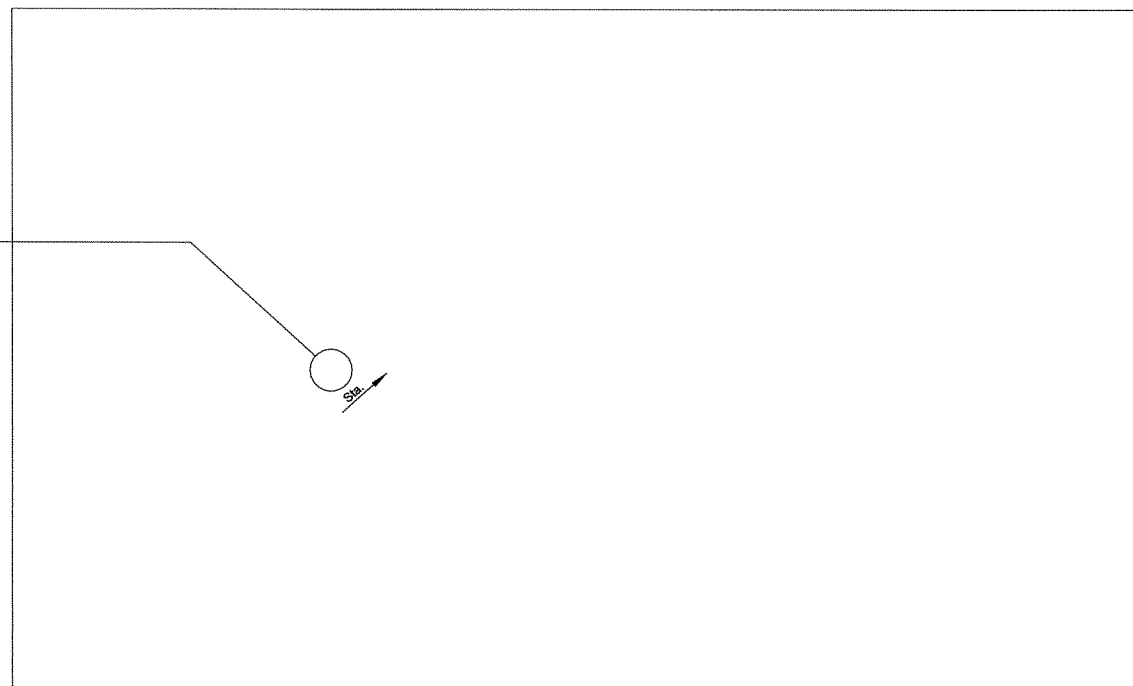

LAYOUT

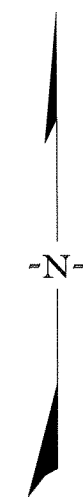

Submit Shop Plans to:  
SCDOT  
Preconstruction Support Engineer  
Attn: Logistics Coordinator - Shop Plans  
955 Park Street - Room 409  
Columbia, SC 29201

Approximate Location of Bridge is  
Latitude 00°-00' - 00"  
Longitude 00°-00' - 00"

	FOR CONSTRUCTION	
	INITIAL	DATE
RPG - HYDROLOGY		
RPG - STRUCTURES		
RPG - GEOTECHNICAL		
PRECONSTRUCTION SUPPORT - STRUCTURES		
RPG - DESIGN MANAGER		
RPG - PROGRAM MANAGER		

3 DAYS BEFORE DIGGING IN  
SOUTH CAROLINA  
**CALL 811**  
PALMETTO UTILITY PROTECTION SERVICES, INC. (PUPS)  
ALL UTILITIES MAY NOT BE A MEMBER OF PUPS.

NET LENGTH OF ROADWAY	0.000	MILES
NET LENGTH OF BRIDGES	0.000	MILES
NET LENGTH OF PROJECT	0.000	MILES
LENGTH OF EXCEPTIONS	0.000	MILES
GROSS LENGTH OF PROJECT	0.000	MILES

NOTE: EXCEPT AS MAY OTHERWISE BE SPECIFIED ON THE PLANS OR IN THE SPECIAL PROVISIONS, ALL MATERIALS AND WORKMANSHIP ON THIS PROJECT SHALL CONFORM TO THE SOUTH CAROLINA DEPARTMENT OF TRANSPORTATION STANDARD SPECIFICATIONS FOR HIGHWAY CONSTRUCTION (2007 EDITION) AND THE STANDARD DRAWINGS FOR ROAD CONSTRUCTION IN EFFECT AT THE TIME OF LETTING.

TRAFFIC DATA			
0000	ADT	0000	
0000	ADT	0000	
	TRUCKS	00	%

ENGINEER OF RECORD

FOR CONSTRUCTION : \_\_\_\_\_ DATE \_\_\_\_\_

Printed: Wednesday, April 02, 2008 11:50:35 AM

REVIEWED	DR.	XXX	BY	CHIK	DATE
		XX-XX			

# ADDITIONAL INFORMATION PROVIDED OUTSIDE THE IN-HOUSE TITLE SHEET BORDER

**Note to Designer:**  
 These information blocks are for use on "fast track" or other similar types of bridge projects where roadway approach plans are incorporated in the bridge plans.

<b>NPDES PERMIT INFORMATION</b>
<p style="text-align: center;">NPDES Disturbed</p> <p>Area = _____ Acre(s)</p>
<p style="text-align: center;">Approximate Location of Roadway is</p> <p>Begin</p> <p>Latitude _____</p> <p>Longitude _____</p> <p>End</p> <p>Latitude _____</p> <p>Longitude _____</p>
<p style="text-align: center;">Hydraulic and NPDES Design provided by:</p> <p>_____</p> <p style="text-align: center; font-size: small;">Designs may be obtained from the SCDOT Regional Production Group</p>

	FOR CONSTRUCTION	
	INITIAL	DATE
RPG - ROAD		
RPG - HYDROLOGY		
RPG - STRUCTURES		
RPG - GEOTECHNICAL		
PRECONSTRUCTION SUPPORT - ROAD		
PRECONSTRUCTION SUPPORT - STRUCTURES		
RPG - DESIGN MANAGER		
RPG - PROGRAM MANAGER		

INDEX OF SHEETS

1. Title Sheet
2. Summary of Estimated Quantities
3. General Notes
4. General Details
5. Reinforcing Bending Details



South Carolina Department of Transportation

PROPOSED PLANS  
FOR

COUNTY  
FILE NO.  
ROUTE  
REPLACE BRIDGE OVER

Note to Designer:  
Consultant to provide contact information including mailing address and telephone number of office responsible for review of shop plans.

Submit Shop Plans to:

Insert Name of Consulting Firm  
Insert Mailing Address

Telephone: (XXX) XXX-XXXX

Approximate Location of Bridge is

Latitude 00°-00'-00"  
Longitude 00°-00'-00"

SITE LOCATION

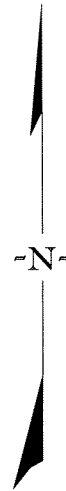
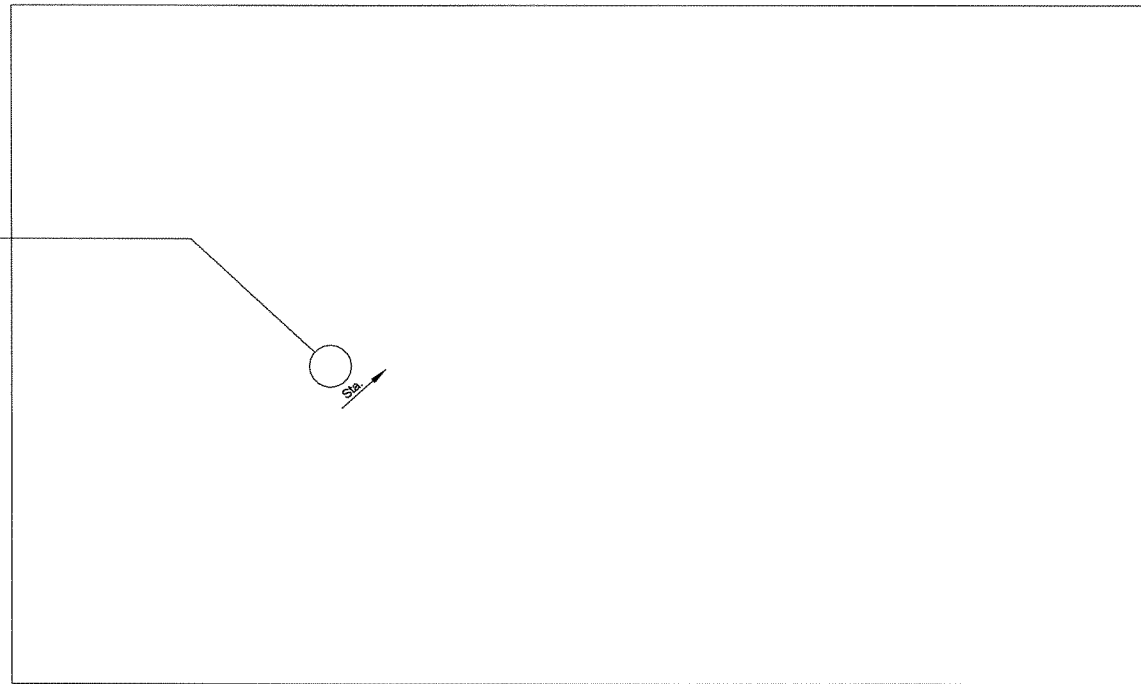

SCDOT REVIEW	FOR CONSTRUCTION	
	INITIAL	DATE
PRECONSTRUCTION SUPPORT - ROAD		
PRECONSTRUCTION SUPPORT - STRUCTURES		
RPG - DESIGN MANAGER		
RPG - PROGRAM MANAGER		

THE INITIALS ABOVE DO NOT RELIEVE THE ENGINEER OF RECORD OF THE RESPONSIBILITY TO DESIGN THIS PROJECT IN ACCORDANCE WITH ALL APPLICABLE CRITERIA.

3 DAYS BEFORE DIGGING IN  
SOUTH CAROLINA

**CALL 811**

PALMETTO UTILITY PROTECTION SERVICES, INC. (PUPS)  
ALL UTILITIES MAY NOT BE A MEMBER OF PUPS.

LAYOUT

NET LENGTH OF ROADWAY	0.000	MILES
NET LENGTH OF BRIDGES	0.000	MILES
NET LENGTH OF PROJECT	0.000	MILES
LENGTH OF EXCEPTIONS	0.000	MILES
GROSS LENGTH OF PROJECT	0.000	MILES

NOTE: EXCEPT AS MAY OTHERWISE BE SPECIFIED ON THE PLANS OR IN THE SPECIAL PROVISIONS, ALL MATERIALS AND WORKMANSHIP ON THIS PROJECT SHALL CONFORM TO THE SOUTH CAROLINA DEPARTMENT OF TRANSPORTATION STANDARD SPECIFICATIONS FOR HIGHWAY CONSTRUCTION (2007 EDITION) AND THE STANDARD DRAWINGS FOR ROAD CONSTRUCTION IN EFFECT AT THE TIME OF LETTING.

CONSULTING ENGINEERING FIRM

ENGINEER OF RECORD

FOR CONSTRUCTION : \_\_\_\_\_ DATE \_\_\_\_\_

TRAFFIC DATA

\_\_\_\_\_ ADT \_\_\_\_\_

\_\_\_\_\_ ADT \_\_\_\_\_

TRUCKS \_\_\_\_\_ %

REVIEWED	DR.	XXX	BY	CHK	DATE
		XXX			XX-XX

# ADDITIONAL INFORMATION PROVIDED OUTSIDE THE CONSULTANT TITLE SHEET BORDER

Note to Designer:

This information block is for use on "fast track" or other similar types of bridge projects where roadway approach plans are incorporated in the bridge plans.

NPDES PERMIT INFORMATION	
NPDES Disturbed	
Area =	_____ Acre(s)
Approximate Location of Roadway is	
Begin	
Latitude	_____
Longitude	_____
End	
Latitude	_____
Longitude	_____
Hydraulic and NPDES Design provided by:	
_____	
Designs may be obtained from the SCDOT Regional Production Group	



South Carolina  
Department of Transportation

**BRIDGE DESIGN MEMORANDUM – DM0308**

**TO:** RPG Structural Engineers  
Structural Design Consultants

**DATE:** June 6, 2008

**RE:** Revised Prestressed Concrete Cored Slab Drawings

The Department's prestressed cored slab drawings have been revised. The revised drawings include the following changes:

- The ½-inch diameter transverse post-tensioning strands have been replaced with 1¼-inch diameter tie rods and the 2-inch diameter holes have been increased to 3 inches to accommodate the 1¼-inch diameter transverse tie rods.
- The dowel hole locations and the elastomeric bearing pad dimensions have been revised.
- A new drawing, Drawing 704-70, has been added that provides details for a 70-foot span.
- Details that are common to all of the spans have been removed from the individual span sheets and placed on a new drawing, Drawing 704-29.

Electronic copies of these drawings can be obtained from the *SCDOT Bridge Drawings and Details* at the Department's website.

When using the updated drawings, the designer should include the new detail sheets (Drawing 704-29) after the span sheet(s). The attached special provision shall be included in contracts containing these updated drawings. The designer must evaluate the design and revise the drawings when barrier parapet transitions or vertical railing walls are required. Due to the camber of the slab units, the designer must also evaluate the design and details of these spans to ensure the required finished grade profile can be maintained.

For previously completed plans that include the ½-inch diameter transverse post-tensioning strands, the designer should allow the Contractor the option of constructing the spans



using the details for the 1¼-inch diameter tie rods. However, the Contractor shall not be allowed to substitute ½-inch diameter transverse post-tensioning strands for the 1¼-inch diameter tie rods that are detailed on the revised drawings.



E. S. Eargle  
Preconstruction Support Engineer

ESE:bwb

Attachment

cc: Bridge Construction Engineer  
Bridge Maintenance Engineer  
FHWA Structural Engineer  
Preconstruction Support Managers  
Regional Production Engineers  
RPG Design Managers

File: PC/BWB

**SPECIAL PROVISION FOR PRESTRESSED CONCRETE CORED SLABS**

**(XX) SECTION 704: PRESTRESSED CORED SLABS:**

Subsection 704.4.6 is amended as follows:

Delete Paragraph 2 of Subsection 704.4.6.2 and replace it with the following:

“Provide holes and recesses at locations indicated in the Shop Plans for insertion of the 1¼ -inch diameter transverse tie rods.

Delete Subsection 704.4.6.5 and replace it with the following:

**“704.4.6.5 Transverse Tie Rods**

In each span, place 1¼-inch diameter transverse tie rods and tighten to a snug fit. After the 1¼-inch diameter transverse tie rods have been tightened in a span and before any equipment, material or barrier parapet is placed on the span, fill the shear keys, dowel holes, and tie rod recesses with the non-shrink grout as indicated on the Plans and allow curing for a minimum of 3 days. Ensure that the grout reaches a compressive strength of 5000 psi in 24 hours. Properly remove any foreign substance/materials including grease from the exposed portions of transverse tie rods before grouting the recesses.

With the approval of the RCE, material and equipment may be placed on the cored slab spans after the transverse tie rods have been tightened, the grout in shear keys has cured for 3 days minimum, and the grout has reached a compressive strength of 5000 psi.”



South Carolina  
Department of Transportation

**BRIDGE DESIGN MEMORANDUM – DM0408**

**TO:** RPG Structural Engineers  
Structural Design Consultants

**DATE:** June 16, 2008

**RE:** Adhesively Bonded Anchors and Dowels

Beginning with the September 2008 Letting, the Supplemental Specification for Adhesively Bonded Anchors and Dowels should be included in all Department Contracts where adhesive anchorages are specified or permitted. This specification contains requirements for the installation and testing of adhesive anchorages and is available at the Department’s website.

The attached “Guidelines for Design of Adhesively Bonded Anchors and Dowels” should be followed when designing adhesive anchorages. The designer shall specify on the plans if field testing is required and, if field testing is required, the designer shall also specify the test load. For each adhesive anchor application that is specified or permitted, one of the following notes shall be included on the plans:

- For applications where field testing is required  
*Provide and install anchorages in accordance with the requirements of the Supplemental Specification for Adhesively Bonded Anchors and Dowels. Use an adhesive bonding system that has a minimum bond strength of 1.5 ksi. Field test the anchorages, using a test load of \_\_\_\_ kips per anchor, in accordance with the requirements of the Supplemental Specification.*
- For applications where field testing is not required  
*Provide and install anchorages in accordance with the requirements of the Supplemental Specification for Adhesively Bonded Anchors and Dowels. Use an adhesive bonding system that has a minimum bond strength of 1.5 ksi. Field testing of the anchorages is not required.*

See Section 3.0 of the attached Guidelines for applications where field testing should be required and for the method to determine the magnitude of the test load.

E. S. Eargle  
Preconstruction Support Engineer

ESE:bwb  
Attachment  
cc: Bridge Construction Engineer  
Bridge Maintenance Engineer  
Director of Traffic Engineering  
FHWA Structural Engineer  
File: PC/BWB

Materials and Research Engineer  
Preconstruction Support Managers  
Regional Production Engineers  
RPG Design Managers





# GUIDELINES FOR DESIGN OF ADHESIVELY BONDED ANCHORS AND DOWELS

## 1.0 Notation

- $A_e$  = effective cross sectional area of steel anchor ( $\text{in}^2$ )
- $A_{no}$  = effective area of a single anchorage in tension ( $\text{in}^2$ ) See Figure 1.1.
- $A_n$  = effective area of a group of anchorages in tension ( $\text{in}^2$ ) See Figure 1.1.
- $A_{vo}$  = effective area of a single anchorage in shear ( $\text{in}^2$ ) See Figure 1.2.
- $A_v$  = effective area of a group of anchorages in shear ( $\text{in}^2$ ) See Figure 1.2.
- $c$  = anchorage edge distance, measured from free edge to centerline of anchorage (in)
- $d$  = diameter of steel anchor (in)
- $f'_c$  = specified minimum 28-day compressive strength of concrete (ksi)
- $f_y$  = specified minimum yield strength of steel anchor (ksi)
- $h$  = concrete member thickness (in)
- $h_e$  = embedment depth of steel anchor (in)
- $N_c$  = nominal tensile resistance of anchorage as controlled by concrete embedment (kips)
- $N_n$  = nominal tensile resistance of anchorage (kips)
- $N_p$  = nominal tensile resistance of anchorage as controlled by pullout (kips)
- $N_s$  = nominal tensile resistance of anchorage as controlled by anchor steel strength (kips)
- $N_u$  = factored tensile load (kips)
- $s$  = anchorage spacing (in)
- $V_c$  = nominal shear resistance of anchorage as controlled by concrete embedment (kips)
- $V_n$  = nominal shear resistance of anchorage (kips)
- $V_s$  = nominal shear resistance of anchorage as controlled by anchor steel strength (kips)
- $V_u$  = factored shear load (kips)
- $T$  = specified minimum bond strength of adhesive (ksi)
- $\phi_c$  = 0.85, resistance factor used for anchorage controlled by concrete embedment
- $\phi_s$  = 0.90, resistance factor used for anchorage controlled by anchor steel strength
- $\Psi_e$  = modification factor for anchorage in tension having an edge distance less than  $8d$
- $\Psi_s$  = modification factor for a group of anchorages in tension having a spacing less than  $16d$
- $\Psi_v$  = modification factor for anchorages in shear

## 2.0 Design Requirements

### 2.1 General Requirements

- a. Where practical, anchorage spacing,  $s$ , should be  $16d$  or greater and anchorages should have an edge distance,  $c$ , greater than or equal to  $8d$ . Anchorage spacing,  $s$ , shall not be less than  $12d$  and anchorages shall have an edge distance,  $c$ , greater than or equal to  $5d$ .
- b. The minimum concrete member thickness,  $h$ , shall be greater than or equal to  $2d + h_e$ .
- c. Adhesive anchorages should be designed for a ductile failure. A ductile failure may be assumed when the following embedment depths are used:
  - For Anchorages in Tension: An embedment depth,  $h_e$ , capable of achieving 125% of the specified minimum yield strength of the anchor,  $f_y$
  - For Anchorages in Shear: An embedment depth,  $h_e$ , equal to 70% of the embedment depth required to achieve 125% of the specified minimum yield strength of the anchor,  $f_y$
- d. Adhesive anchorages shall not be used in overhead or upwardly inclined installations. See Figure 1.3.
- e. Adhesive anchorages shall not be used in applications having predominately sustained tensile loads and lack of structural redundancy. Predominately sustained tensile loads are defined as loadings where the permanent component of the factored tensile load,  $N_u$ , exceeds 30% of the nominal tensile resistance,  $N_n$ .
- f. Adhesive anchorages should not be used on prestressed concrete members.

### 2.2 Tensile Loading

Anchorages loaded in tension shall have an embedment depth,  $h_e$ , greater than or equal to  $8d$ .

Anchorages shall be designed such that:

$$\phi N_n \geq N_u$$

where:

$$\phi N_n = \text{the lesser of } \phi N_s \text{ or } \phi N_p$$

The tensile resistance of the anchorage steel shall be taken as:

$$\phi N_s = \phi_s A_e f_y$$

The tensile resistance of the anchorage bond shall be taken as:

$$\phi N_p = \phi_c \Psi_e \Psi_s N_c$$

where:

$$\Psi_e = 1.0 \text{ when } c \geq 8d$$

and

$$\Psi_e = 0.70 + 0.30 (c / 8d) \text{ when } 8d > c \geq 5d$$

$$\Psi_s = 1.0 \text{ when } s \geq 16d$$

and

$$\Psi_s = A_n / A_{no} \text{ when } 16d > s \geq 12d$$

$$N_c = T \pi d h_e$$

### 2.3 Shear Loading

Anchors loaded in shear shall have an embedment depth,  $h_e$ , greater than or equal to  $6d$ .

Anchorage shall be designed such that:

$$\phi V_n \geq V_u$$

where:

$$\phi V_n = \text{the lesser of } \phi V_s \text{ or } \phi V_c$$

The shear resistance of the anchorage steel shall be taken as:

$$\phi V_s = \phi_s 0.7 A_e f_y$$

The shear resistance based on concrete strength shall be taken as:

$$\phi V_c = \phi_c \Psi_v 0.317 \sqrt{d} \sqrt{f'_c} c^{1.5}$$

where:

$$\Psi_v = 1.0 \text{ when } s \geq 3c \text{ and } h \geq 1.5c$$

and

$$\Psi_v = A_v / A_{vo} \text{ when } s < 3c \text{ and/or } h < 1.5c$$

## 2.4 Interaction of Tensile and Shear Loadings

For combinations of tensile and shear loadings, anchorages shall be designed such that:

$$(N_u / \phi N_n) + (V_u / \phi V_n) \leq 1.0$$

where:

$$\phi N_n = \text{the lesser of } \phi N_s \text{ or } \phi N_p$$

$$\phi V_n = \text{the lesser of } \phi V_s \text{ or } \phi V_c$$

## 3.0 Field Testing Requirements

### 3.1 Field Testing Applications

Field testing of adhesively bonded anchors and dowels should be required for the following applications:

- Anchor bolts used to attach metal railing posts to top of concrete rails or parapets
- Dowels used to attach cast-in-place wingwalls/headwalls/curtain walls to precast culverts
- Dowels used for bridge widening or staged construction between substructure units or bridge decks
- Anchor bolts for bearing replacements for rehabilitation work
- Attachments of guardrails to culverts
- Attachments of temporary concrete barrier to bridge decks

Field testing of adhesively bonded anchors and dowels should not be required for the following applications:

- Dowels used to attach sidewalks to bridge decks
- Dowels used for culvert extensions

For applications other than those listed above, the designer shall determine the need for field testing.

### 3.2 Field Test Loads

When field testing is required, the test load shall be specified on the Plans. The test load should be the lesser of  $0.85 N_c$  or  $0.9 A_e f_y$ .

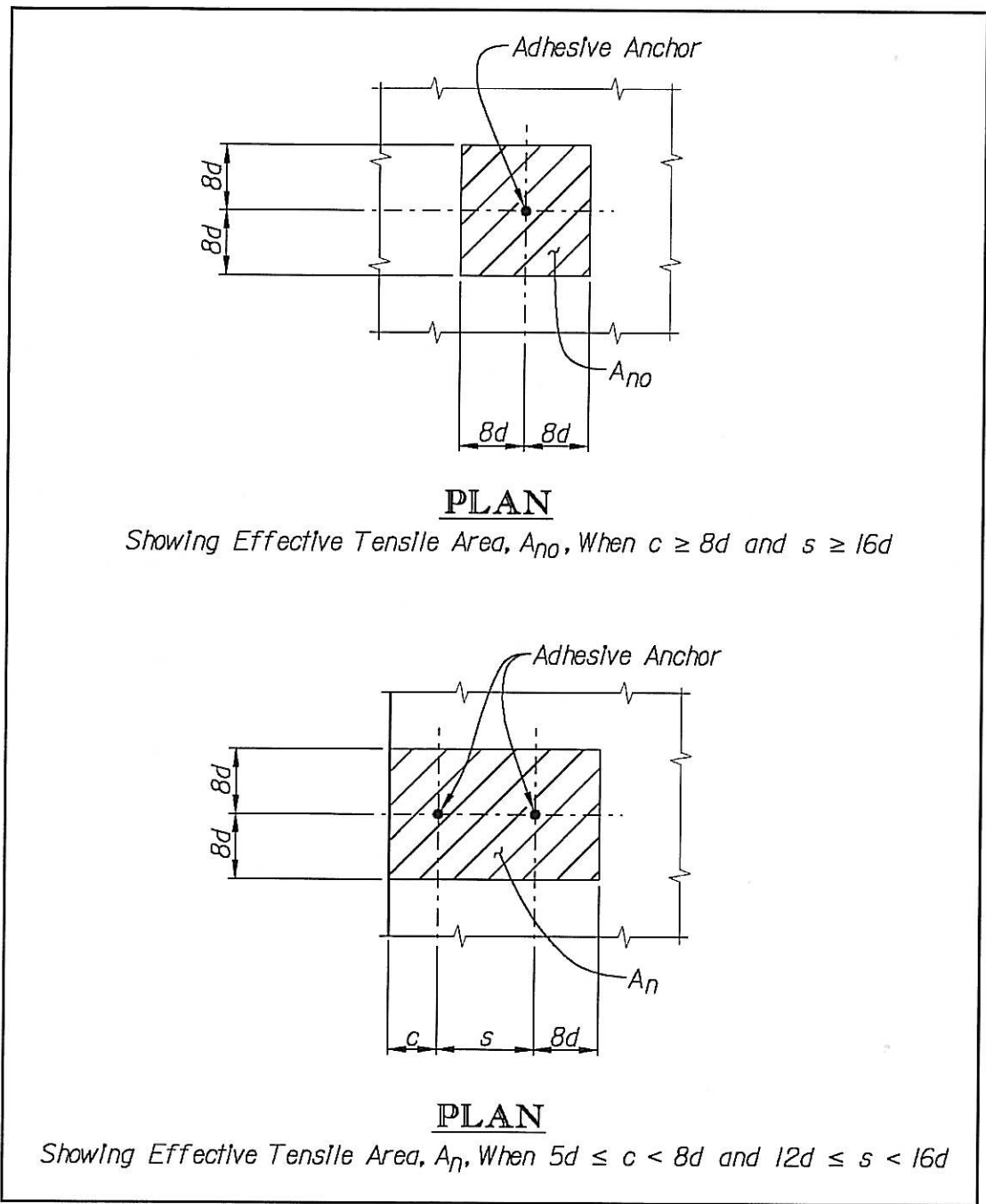

**FIGURE 1.1**

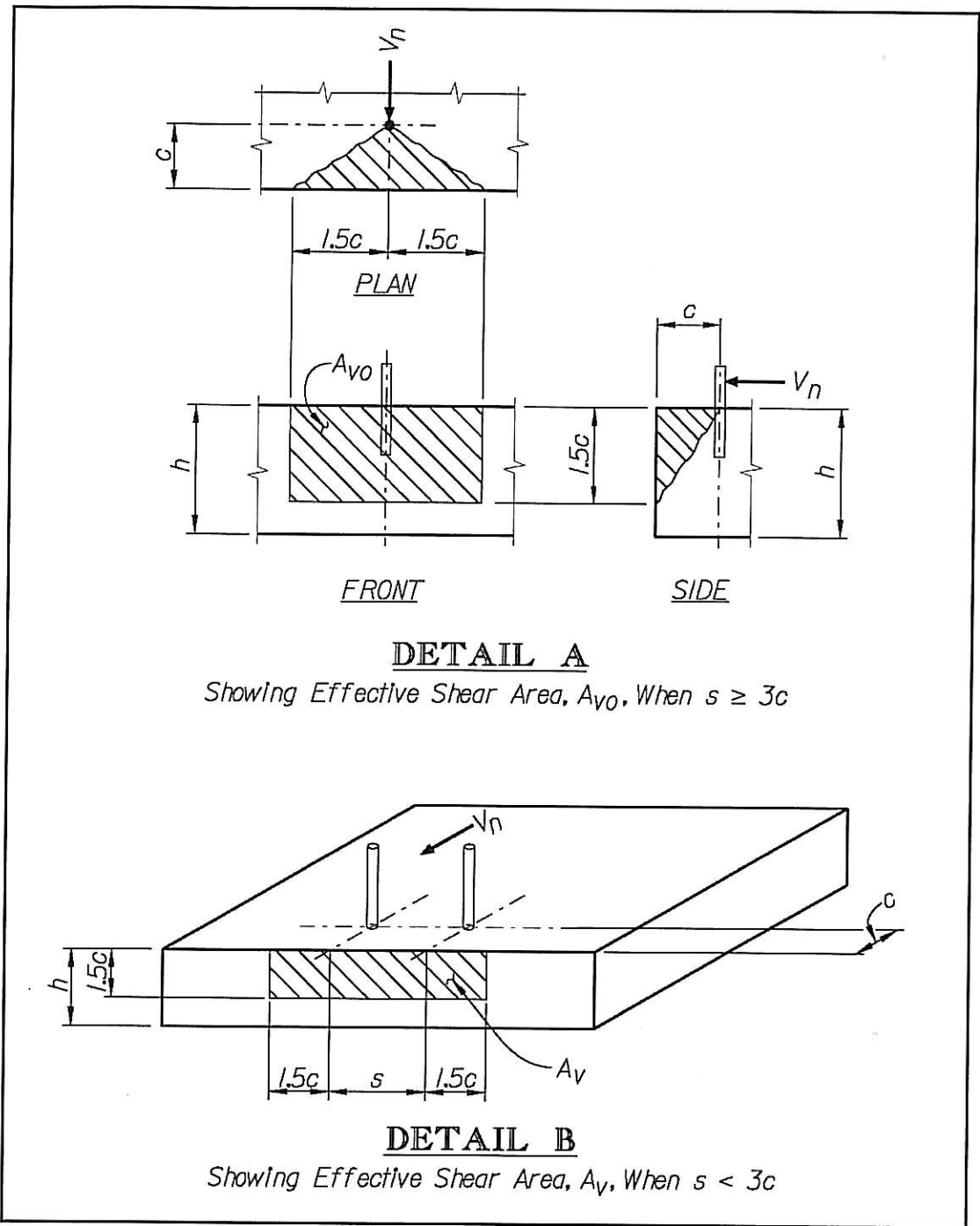

**FIGURE 1.2**

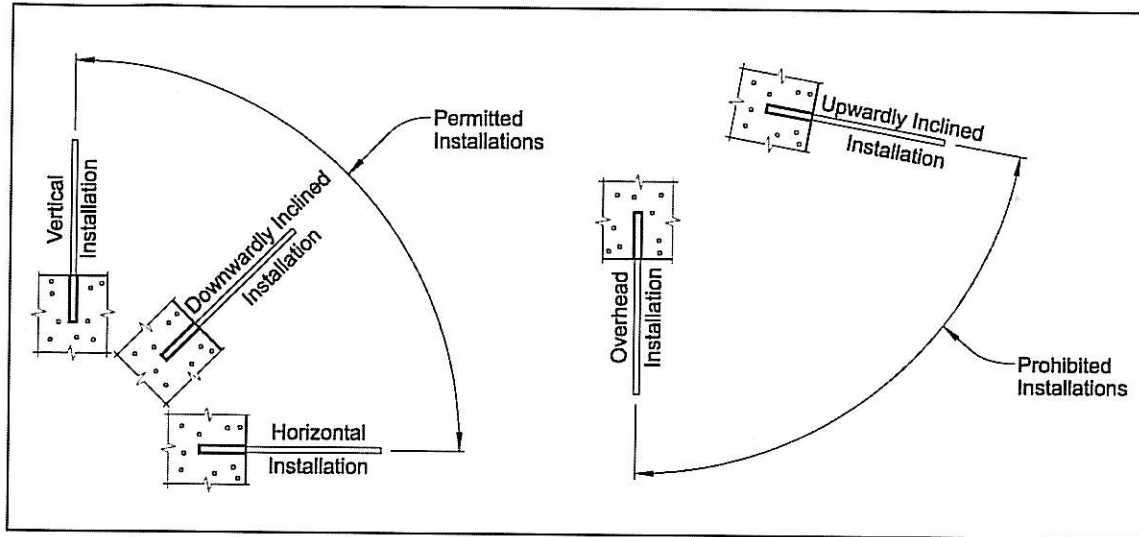

FIGURE 1.3



South Carolina  
Department of Transportation

**BRIDGE DESIGN MEMORANDUM – DM0508**

**TO:** RPG Structural Engineers  
Design Consultants

**DATE:** August 28, 2008

**RE:** *SCDOT Geotechnical Design Manual* and Updated *SCDOT Seismic Design Specifications for Highway Bridges*

Effective October 1, 2008, designs for all new South Carolina Department of Transportation (SCDOT) projects shall comply with the requirements of the *SCDOT Seismic Design Specifications for Highway Bridges*, Version 2.0 and the first 12 Chapters of the *SCDOT Geotechnical Design Manual*, Version 1.0. For projects currently in the preliminary design phase (i.e., when the subsurface exploration has not been performed), the Department's Project Manager may also elect to require the use of these documents.

These documents may be purchased from the Department's Engineering Publications Office at (803) 737-4533 or at [enrpubsales@dot.state.sc.us](mailto:enrpubsales@dot.state.sc.us). The cost of the seismic specifications is \$25.00 per copy and the cost of Chapters 1 through 12 of the geotechnical manual is \$65.00 per copy.

Drawings 700-03 and 700-04 of the *SCDOT Bridge Drawings and Details* have been revised to reference the updated seismic specifications. Section 11.2.2 of the *SCDOT Bridge Design Manual* shall be revised as follows:

Where conflicts are observed in those publications and documents used by SCDOT, the following hierarchy of priority shall be used to determine the appropriate application:

1. Bridge Design Memorandums issued after May 2006,
2. *SCDOT Bridge Design Manual*,
3. *SCDOT Seismic Design Specifications for Highway Bridges*,
4. *SCDOT Geotechnical Design Manual*,
5. *LRFD Bridge Design Specifications*, and
6. all other publications.

As the need arises, Bridge Design Memorandums will be issued to supplement or revise the requirements of the referenced documents.

E. S. Eagle  
Preconstruction Support Engineer

ESE:bwb

cc: Bridge Construction Engineer  
Bridge Maintenance Engineer  
Director of Traffic Engineering  
FHWA Structural Engineer

File: PC/BWB

Materials and Research Engineer  
Preconstruction Support Managers  
Regional Production Engineers  
RPG Design Managers





**BRIDGE DESIGN MEMORANDUM – DM0608**

**TO:** RPG Structural Engineers  
Design Consultants

**DATE:** October 14, 2008

**RE:** *SCDOT Seismic Design Specifications for Highway Bridges, Version 2.0*  
Corrections to Equations 9-1 and 9-2

After publication of the *SCDOT Seismic Design Specifications for Highway Bridges, Version 2.0*, errors were noted in Equations 9-1 and 9-2 on page 9-1. The correct equations are shown below:

Equation 9-1

$$N = (4 + \Delta_{ot} + 0.2H_s) \left(1 + \frac{S^2}{4000}\right) \geq 12''$$

Equation 9-2

$$N = (4 + \Delta_{ot} + 1.65\Delta_{eq}) \left(1 + \frac{S^2}{4000}\right) \geq 14''$$

Attached is a revised copy of page 9-1 that can be used to update your copy of the Specifications.

*Original Signed by E. S. Eargle on October 14, 2008*

E. S. Eargle  
Preconstruction Support Engineer

ESE:bwb  
Attachment  
cc: Bridge Construction Engineer  
Bridge Maintenance Engineer  
FHWA Structural Engineer  
File: PC/BWB

Preconstruction Support Managers  
Regional Production Engineers  
RPG Design Managers



## SECTION 9 – MISCELLANEOUS DETAILING

### 9.1 MINIMUM SUPPORT LENGTH

The minimum support length at expansion bents and free standing or non-integral end bents shall accommodate the differential seismic displacements between the substructure and the superstructure. The minimum support length capacity shall meet or exceed the minimum support length demand of the superstructure. Support length at fixed bents (superstructure continuous over the bents) need not be computed. The minimum support length (see Figure 9.1) is computed using Equation 9-1 or 9-2.

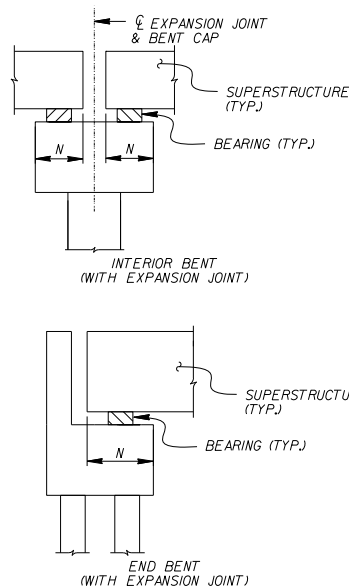

**Figure 9.1 Dimensions for Support Length Requirement**

#### 9.1.1 SDC A and Single Span Bridges

$$N = \left(4 + \Delta_{ot} + 0.2H_s\right) \left(1 + \frac{S^2}{4000}\right) \geq 12" \quad (9-1)$$

Where:

- $N$  Minimum support length (in)
- $\Delta_{ot}$  Movement attributed to prestress shortening creep, shrinkage and thermal expansion or contraction to be considered no less than one inch per 100 feet of bridge superstructure length between expansion joints (in)
- $H_s$  The largest column height in the most flexible frame adjacent to the expansion joint under consideration. The average height from the top of column to top of footing for pile bents, or to the point of fixity of drilled shaft or pile foundations. For single spans seated on abutments, the term is taken as the abutment height (ft)
- $S$  The skew angle of the bridge substructure measured from a line normal to the span (degrees)

#### 9.1.2 SDC B and C Bridges

$$N = \left(4 + \Delta_{ot} + 1.65\Delta_{eq}\right) \left(1 + \frac{S^2}{4000}\right) \geq 14" \quad (9-2)$$

Where:

- $N$  Minimum support length (in)
- $\Delta_{eq}$  Seismic displacement demand of the long period frame on one side of the expansion joint (in)
- $\Delta_{ot}$  Movement attributed to prestress shortening creep, shrinkage and thermal expansion or contraction to be considered no less than one inch per 100 feet of bridge superstructure length between expansion joints (in)

#### 9.1.3 SDC D Bridges

The minimum support length for SDC D bridges shall satisfy Equation 9-2 except the lower boundary is 24".

### 9.2 LONGITUDINAL AND TRANSVERSE CONNECTIONS

Transverse seismic forces are transmitted to the substructure through dowel bars, anchor bolts and/or shear keys. Typically, these components are designed to behave elastically so that the combination of anchor bolts, dowel bars and/or shear keys are designed to satisfy Equation 9-3 in both the longitudinal and transverse directions for bridges of any SDC.

$$V_u \leq \phi_v (V_{sk} + V_{ab} + V_{bw}) \quad (9-3)$$

Where:

- $V_u$  Smaller of elastic shear force or the overstrength plastic hinge shear force (k)
- $V_{sk}$  Shear strength of the shear key (k)
- $V_{ab}$  Shear strength of anchor bolts (k)
- $V_{bw}$  Shear strength of the backwall (k)
- $\phi_v$  Shear strength reduction factor (dimensionless)

**BRIDGE DESIGN MEMORANDUM – DM0109**

**TO:** RPG Structural Engineers  
Design Consultants

**DATE:** January 27, 2009

**RE:** Exceptions to SCDOT Structural Design Criteria

This memorandum updates the Department’s requirements for obtaining a design exception to structural design criteria. A Structural Design Exception Request must be completed when a designer proposes a design element that does not meet the criteria or policies of the *SCDOT Bridge Design Manual*, the *SCDOT Seismic Design Specifications for Highway Bridges*, the *SCDOT Geotechnical Design Manual*, or the *AASHTO LRFD Bridge Design Specifications*.

Section 11.2.3 of the *SCDOT Bridge Design Manual* shall be deleted and replaced with the following:

**11.2.3 Structural Design Exceptions**

This Section discusses the Department’s procedures for identifying, justifying, and processing exceptions to the structural design criteria in the *SCDOT Bridge Design Manual*, the *SCDOT Seismic Design Specifications for Highway Bridges*, the *SCDOT Geotechnical Design Manual*, and the *AASHTO LRFD Bridge Design Specifications*.

**11.2.3.1 Department Intent**

The general intent of the South Carolina Department of Transportation is that all of its structural design criteria shall be met. However, recognizing that this may not always be practical, the Department has established a process to evaluate and approve exceptions to its structural design criteria.

**11.2.3.2 Procedures**

Structural Design Exception Requests are only required where criteria or policies in the *SCDOT Bridge Design Manual*, the *SCDOT Seismic Design Specifications for Highway Bridges*, the *SCDOT Geotechnical Design Manual*, or the *AASHTO LRFD Bridge Design Specifications* are presented in one of the following contexts (or the like):

- “shall,”
- “mandatory,” or
- “required.”



January 27, 2009

When a design exception is identified, the designer will first seek to eliminate the exception to design. If the design exception cannot be eliminated, the Regional Production Group Design Manager (for In-House Designed Projects) or the Engineer of Record (for Consultant Designed Projects) will prepare a Structural Design Exception Request and submit it to the Program/Project Manager. The request shall include the attached request form and any supporting data needed for justification. The justification may include items such as site constraints, construction costs, construction considerations, environmental impacts, and/or right-of-way impacts.

The Program/Project Manager will present the Structural Design Exception Request to the Regional Production Engineer. If the Regional Production Engineer recommends approval, the request will be forwarded to the Structural Design Support Engineer. The Structural Design Support Engineer will perform an objective review, from a statewide perspective, and may attach comments to the request. The request will then be returned to the Regional Production Engineer, who will submit the request to the Director of Preconstruction for consideration of approval. For projects where the Federal Highway Administration has full oversight, the Director of Preconstruction will submit approved requests to the Federal Highway Administration for concurrence.

At many locations in the *SCDOT Bridge Design Manual*, the text specifically states that approvals are required by the State Bridge Design Engineer. For these instances, a Structural Design Exception Request is not required. Because the position of State Bridge Design Engineer does not exist in the current organization of Preconstruction, this type of approval must be obtained, in writing, from the appropriate Regional Production Engineer. To ensure consistency is maintained statewide, the Regional Production Groups should coordinate with the Preconstruction Support Group when considering these approval requests and copies of approvals should be forwarded to the Preconstruction Support Engineer.

*Original Signed by E. S. Eargle on January 27, 2009*

E. S. Eargle  
Preconstruction Support Engineer

ESE:bwb

Attachment

cc: Bridge Construction Engineer  
Bridge Maintenance Engineer  
FHWA Structural Engineer

Preconstruction Support Managers  
Regional Production Engineers  
RPG Design Managers

File: PC/BWB



**STRUCTURAL DESIGN EXCEPTION REQUEST**

Submitted to: \_\_\_\_\_  
Program/Project Manager

Submitted by: \_\_\_\_\_  
RPG Design Manager or Engineer of Record

Date: \_\_\_\_\_

**PROJECT INFORMATION**

PCN: \_\_\_\_\_  
County: \_\_\_\_\_  
Route: \_\_\_\_\_  
Crossing: \_\_\_\_\_  
Project Type (Replacement, Rehabilitation, etc.): \_\_\_\_\_  
Traffic Data: \_\_\_\_\_  
Project Cost Estimate: \_\_\_\_\_

**BASIS OF DESIGN EXCEPTION**

- Request for Approval of Design Exception to *SCDOT Bridge Design Manual*
- Request for Approval of Design Exception to *SCDOT Seismic Design Specifications for Highway Bridges*
- Request for Approval of Design Exception to *SCDOT Geotechnical Design Manual*
- Request for Approval of Design Exception to *AASHTO LRFD Bridge Design Specifications*

**\*DESCRIPTION OF DESIGN EXCEPTION**

\_\_\_\_\_  
\_\_\_\_\_  
\_\_\_\_\_  
\_\_\_\_\_

**\*JUSTIFICATION FOR DESIGN EXCEPTION**

\_\_\_\_\_  
\_\_\_\_\_  
\_\_\_\_\_  
\_\_\_\_\_

**\*DESCRIPTION OF NECESSARY ACTIONS AND ASSOCIATED COSTS TO ELIMINATE DESIGN EXCEPTION**

---

---

---

---

---

**\*DESCRIPTION OF HOW DESIGN EXCEPTION MAY IMPACT FUTURE CONSTRUCTION**

---

---

---

---

---

\*Attach additional pages if needed.

**RECOMMENDED:**

\_\_\_\_\_ Date: \_\_\_\_\_  
Regional Production Engineer

**REVIEWED:**     No Comments     Comments Attached

\_\_\_\_\_ Date: \_\_\_\_\_  
Structural Design Support Engineer

**APPROVED:**

\_\_\_\_\_ Date: \_\_\_\_\_  
Director of Preconstruction

**FHWA CONCURRENCE:** (For Full Oversight Projects)

\_\_\_\_\_ Date: \_\_\_\_\_  
Federal Highway Administration

**BRIDGE DESIGN MEMORANDUM – DM0209**

**TO:** RPG Structural Engineers  
Design Consultants

**DATE:** February 20, 2009

**RE:** Steel H-Pile Anchorage Detail  
Figure 19.2-2 of the *SCDOT Bridge Design Manual*

Figure 19.2-2 of the *SCDOT Bridge Design Manual* shall be deleted and replaced with the attached detail. The revised detail allows the Contractor the option to either drill or flame cut the anchorage holes. To provide a construction tolerance for the holes, the designer must specify a minimum and maximum hole size.

A minimum of two #6 (#19) bars shall be used for the anchorage. The maximum hole size should be limited to two times the diameter of the bar and the minimum hole size should be ¼" larger than the bar diameter. The reinforcing bar must be detailed with sufficient length to fully develop the bar beyond the bottom mat of the footing or bent cap reinforcement.

*Original Signed by E. S. Eargle on February 20, 2009*

E. S. Eargle  
Preconstruction Support Engineer

ESE:bwb  
Attachment  
cc: Bridge Construction Engineer  
Bridge Maintenance Engineer  
FHWA Structural Engineer  
File: PC/BWB

Preconstruction Support Managers  
Regional Production Engineers  
RPG Design Managers



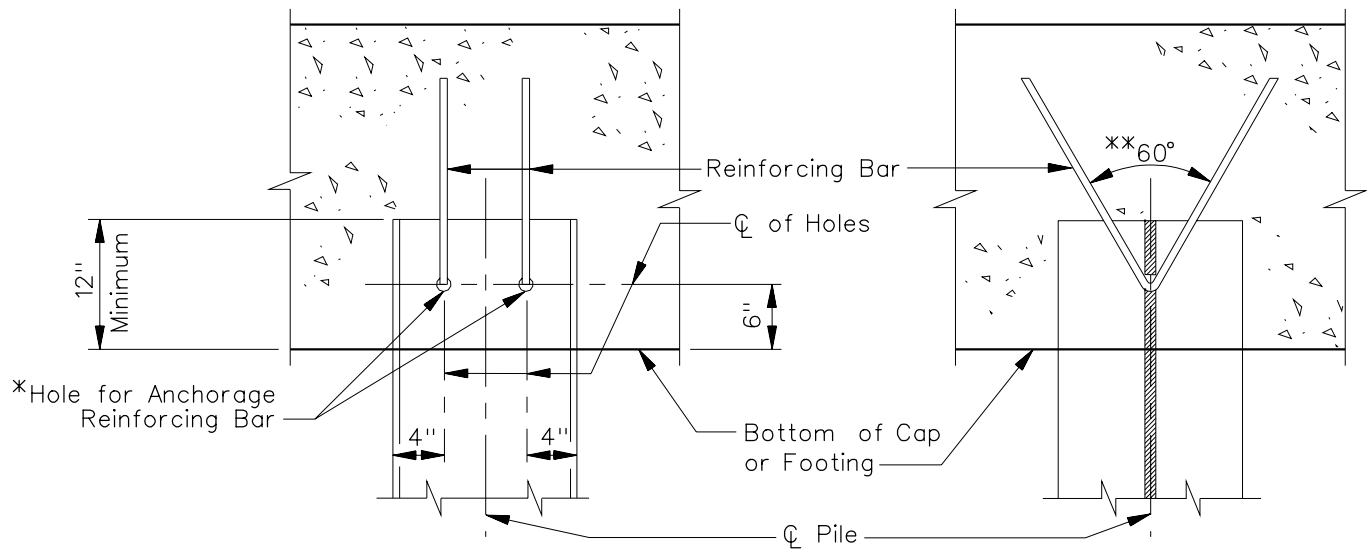

Note: Drill or flame cut the holes. Grind area around flame cut holes to remove burrs. Tie or wedge tightly the reinforcing bar against the top of the hole.

## Steel H-Pile Anchorage Detail

\* Designer to specify a minimum and maximum allowable hole diameter. The minimum diameter should be  $\frac{1}{4}$ " larger than the reinforcing bar diameter and the maximum diameter should be two times the bar diameter.

\*\* Preferred angle is  $60^\circ$  - If necessary, Designer may adjust angle to allow for development length of the reinforcing bar.



**BRIDGE DESIGN MEMORANDUM – DM0309**

**TO:** RPG Structural Engineers  
Design Consultants

**DATE:** July 16, 2009

**RE:** Guardrail-To-Bridge-Rail Transitions  
Section 17.6.1.3 of the *SCDOT Bridge Design Manual*

Section 17.6.1.3 of the *SCDOT Bridge Design Manual* shall be deleted and replaced with the following:

**17.6.1.3 Guardrail-To-Bridge-Rail Transitions**

The roadway designer is responsible for specifying the guardrail-to-bridge-rail transition for the approaching roadway. However, site conditions may present problems for the necessary transition. Therefore, the bridge designer should coordinate with the roadway designer to ensure compatibility between the guardrail-to-bridge-rail transition and the site.

The bridge designer shall review the proposed guardrail-to-bridge-rail transition to determine if any conflicts exist between bridge components (such as end bent caps or sleeper slabs) and the guardrail post installations. If a conflict is found, the bridge designer shall first attempt to revise the details of the bridge component to permit the installation of driven guardrail posts in accordance with the *SCDOT Standard Drawings*. If necessary, the bridge designer may specify additional guardrail offset blocks. Two offset blocks are permitted at any post location and a third offset block may be used at one post only for each guardrail-to-bridge-rail transition.

If the conflict cannot be removed, the bridge designer shall design and detail a method for attaching the guardrail post to the bridge component and include the attachment details in the bridge plans.



In cases where guardrail post attachments or additional guardrail offset blocks are necessary, the bridge designer must coordinate with the roadway designer to ensure that the roadway plans include information describing the installation requirements. For installations requiring additional offset blocks, the roadway designer must determine if additional length guardrail posts are needed. The plans should contain a note instructing the Contractor to include all costs for additional guardrail offset blocks, additional length posts, and/or guardrail post attachments in the unit price bid for Thrie Beam Guardrail Bridge Connector.

*Original Signed by E. S. Eargle on July 16, 2009*

E. S. Eargle  
Preconstruction Support Engineer

ESE:bwb  
cc: Bridge Construction Engineer  
Bridge Maintenance Engineer  
FHWA Structural Engineer  
Preconstruction Support Managers  
File: PC/BWB

Regional Production Engineers  
RPG Design Managers  
RPG Road Design Leaders

**BRIDGE DESIGN MEMORANDUM – DM0409**

**TO:** RPG Structural Engineers  
Design Consultants

**DATE:** November 30, 2009

**RE:** *SCDOT Americans with Disabilities Act Transition Plan*

Section 11.4 of the *SCDOT Bridge Design Manual* shall be amended to include the following:

**11.4.8** ***SCDOT Americans with Disabilities Act Transition Plan***

The *SCDOT Americans with Disabilities Act Transition Plan* sets forth the steps necessary to complete physical and other modifications of SCDOT facilities and programs for which SCDOT is responsible in order to achieve the accessibility required by Title II of the Americans with Disabilities Act of 1990. All plans for new construction, alterations, and encroachments shall be developed to assure compliance with applicable provisions of the *SCDOT Americans with Disabilities Act Transition Plan*.

The *SCDOT Americans with Disabilities Act Transition Plan* is available at the SCDOT website.

*Original Signed by E. S. Eargle on November 30, 2009*

E. S. Eargle  
Preconstruction Support Engineer

ESE:afg  
cc: Bridge Construction Engineer  
Bridge Maintenance Engineer  
FHWA Structural Engineer  
File: PC/BWB

Preconstruction Support Managers  
Regional Production Engineers  
RPG Design Managers



**BRIDGE DESIGN MEMORANDUM – DM0509**

**TO:** RPG Structural Engineers  
Design Consultants

**DATE:** November 30, 2009

**RE:** Section 17.6.1.5 of the *SCDOT Bridge Design Manual*

Item 2 of Section 17.6.1.5 of the *SCDOT Bridge Design Manual* shall be deleted and replaced with the following:

2.  $V \geq 50$  mph. Place the 32-in concrete bridge barrier parapet between pedestrians and traffic; i.e., between the roadway portion of the bridge deck and the sidewalk. The 32-in concrete barrier must have a metal hand rail on top of the barrier to reach the required 42-in height for a pedestrian rail. A 42-in pedestrian rail is then used at the outside edge of the sidewalk. The sidewalk portion shall be detailed with a cross slope no greater than 2 percent as shown in Figure 12.6-7.

*Original Signed by E. S. Eargle on November 30, 2009*

E. S. Eargle  
Preconstruction Support Engineer

ESE:afg  
cc: Bridge Construction Engineer  
Bridge Maintenance Engineer  
FHWA Structural Engineer  
File: PC/BWB

Preconstruction Support Managers  
Regional Production Engineers  
RPG Design Managers



**BRIDGE DESIGN MEMORANDUM – DM0110**

**TO:** RPG Structural Engineers  
Design Consultants

**DATE:** January 15, 2010

**RE:** Section 11.3.9 of the *SCDOT Bridge Design Manual*

Section 11.3.9 of the *SCDOT Bridge Design Manual* shall be deleted and replaced with the following:

**11.3.9 LRFD Guide Specifications for the Design of Pedestrian Bridges**

**11.3.9.1 Description**

The AASHTO *LRFD Guide Specifications for the Design of Pedestrian Bridges* applies to bridges intended to carry primarily pedestrian traffic and/or bicycle traffic. This document provides guidance on the design and construction of pedestrian bridges in addition to that available in the *AASHTO LRFD Bridge Design Specifications*.

**11.3.9.2 Department Application**

The AASHTO *LRFD Guide Specifications for the Design of Pedestrian Bridges* shall be used for the design of pedestrian bridges in conjunction with the *AASHTO LRFD Bridge Design Specifications*.

*Original Signed by E. S. Eargle on January 15, 2010*

E. S. Eargle  
Preconstruction Support Engineer

ESE:afg  
cc: Bridge Construction Engineer  
Bridge Maintenance Engineer  
FHWA Structural Engineer  
File: PC/BWB

Preconstruction Support Managers  
Regional Production Engineers  
RPG Design Managers



**BRIDGE DESIGN MEMORANDUM – DM0210**

**TO:** RPG Structural Engineers  
Design Consultants

**DATE:** June 1, 2010

**RE:** *SCDOT Geotechnical Design Manual* – Version 1.1

Effective July 1, 2010, designs for all new South Carolina Department of Transportation (SCDOT) projects shall comply with the requirements of the *SCDOT Geotechnical Design Manual*, Version 1.1. Version 1.1 is comprised of the August 2008, Version 1.0 Edition, and the June 2010 Chapters 13 through 26 and Appendices B through G, which are joined together to form the complete *SCDOT Geotechnical Design Manual*. For projects currently in the preliminary design phase (i.e., when the subsurface exploration has not been performed), the Department's Project Manager may also elect to require the use of Version 1.1.

These documents may be purchased from the Department's Engineering Publications Office at (803) 737-4533 or at [engrpubsales@dot.state.sc.us](mailto:engrpubsales@dot.state.sc.us). The Manual will also be available on the SCDOT website.

As the need arises, Bridge Design Memorandums will be issued to supplement or revise the requirements of the Manual.

*Original Signed by E. S. Eargle on June 1, 2010*

E. S. Eargle  
Preconstruction Support Engineer

ESE:afg  
cc: Bridge Construction Engineer  
Bridge Maintenance Engineer  
Director of Traffic Engineering  
FHWA Structural Engineer  
File: PC/BWB

Materials and Research Engineer  
Preconstruction Support Managers  
Regional Production Engineers  
RPG Design Managers



**BRIDGE DESIGN MEMORANDUM – DM0310**

**TO:** RPG Structural Engineers  
Design Consultants

**DATE:** July 22, 2010

**RE:** *SCDOT Geotechnical Design Manual, Version 1.1*  
Revisions to Chapter 9, Chapter 16, and Appendix A

Tables 9-1, 9-2, 9-6, 9-7, 9-9, and 9-10 of the *SCDOT Geotechnical Design Manual* shall be deleted and replaced with the following tables:

**Table 9-1, Resistance Factors for Shallow Foundations**

Performance Limit		Limit States		
		Strength	Service	Extreme Event
Soil Bearing Resistance (Soil)	OC= I, II, III; ROC = I	0.40	N/A	0.60
	ROC = II or III	0.45		0.65
Soil Bearing Resistance (Rock)	OC= I, II, III; ROC = I	0.40	N/A	0.60
	ROC = II or III	0.45		0.65
Sliding Frictional Resistance (Cast-in-place Concrete on Sand)	OC= I, II, III; ROC = I	0.70	N/A	0.90
	ROC = II or III	0.80		0.95
Sliding Frictional Resistance (Cast-in-place Concrete on Clay)	OC= I, II, III; ROC = I	0.75	N/A	0.90
	ROC = II or III	0.85		0.95
Sliding Frictional Resistance (Precast Concrete on Sand)	OC= I, II, III; ROC = I	0.80	N/A	0.95
	ROC = II or III	0.90		1.00
Sliding Soil on Soil	OC= I, II, III; ROC = I	0.80	N/A	0.95
	ROC = II or III	0.90		1.00
Sliding Passive Resistance (Soil)	OC= I, II, III; ROC = I	0.40	N/A	0.55
	ROC = II or III	0.50		0.65
Lateral Displacement		N/A	1.00	1.00
Vertical Settlement		N/A	1.00	1.00



**Table 9-2, Geotechnical Resistance Factors for Driven Piles**

Analysis and Method of Determination	Limit States			
	Strength		Service	Extreme Event
	Redundant	Non-Redundant		
Nominal Resistance Single Pile in Axial Compression with Wave Equation <sup>(1)</sup> (Soil)	0.40	0.30	N/A	1.00
Nominal Resistance Single Pile in Axial Compression with Wave Equation <sup>(1)</sup> (IGM and Rock)	0.50	0.40	N/A	1.00
Nominal Resistance Single Pile in Axial Compression with Dynamic Testing (PDA) and calibrated Wave Equation <sup>(2)</sup>	0.65	0.55	N/A	1.00
Nominal Resistance Single Pile in Axial Compression with Static Load Testing. Dynamic Monitoring (PDA) of test pile installation and calibrated Wave Equation <sup>(2,3)</sup>	See Table 9-4		N/A	1.00
Nominal Resistance Single Pile in Axial Compression with Statnamic Load Testing For Friction Piles. Dynamic Monitoring (PDA) of test pile installation and calibrated Wave Equation <sup>(2)</sup>	0.65	0.55	N/A	1.00
Nominal Resistance Single Pile in Axial Compression with Statnamic Load Testing For End Bearing Piles in Rock, IGM, or Very Dense Sand. Dynamic Monitoring (PDA) of test pile installation and calibrated Wave Equation <sup>(2)</sup>	0.70	0.55	N/A	1.00
Pile Group Block Failure (Clay)	0.60	N/A	N/A	1.00
Nominal Resistance Single Pile in Axial Uplift Load with No Verification	0.35	0.25	N/A	0.80
Nominal Resistance Single Pile in Axial Uplift Load with Static Load Testing	0.60	0.50	N/A	0.80
Group Uplift Resistance	0.50	N/A	N/A	N/A
Single or Group Pile Lateral Load – Geotechnical Analysis	1.00	1.00	1.00	1.00
Single or Group Pile Vertical Settlement	N/A	N/A	1.00	1.00
Pile Drivability – Geotechnical Analysis	1.00	1.00	N/A	N/A

<sup>(1)</sup> Applies only to factored loads less than or equal to 600 kips.

<sup>(2)</sup> See Table 9-3 for frequency of dynamic testing required.

<sup>(3)</sup> See Table 9-4 for number of static load testing required.



**Table 9-6, Resistance Factors for Rigid Gravity Retaining Walls**

Performance Limit		Limit States		
		Strength	Service	Extreme Event
Soil Bearing Resistance (Soil)	ROC = I, II	0.45	N/A	0.60
	ROC = III	0.45	N/A	0.60
Soil Bearing Resistance (Rock)		0.45	N/A	0.60
Sliding Frictional Resistance (Cast-in-place Concrete on Sand)	ROC = I, II	0.70	N/A	0.90
	ROC = III	0.80		0.95
Sliding Frictional Resistance (Cast-in-place Concrete on Clay)	ROC = I, II	0.75	N/A	0.90
	ROC = III	0.85		0.95
Sliding Frictional Resistance (Precast Concrete on Sand)	ROC = I, II	0.80	N/A	0.95
	ROC = III	0.90		1.00
Sliding Soil on Soil	ROC = I, II	0.80	N/A	0.95
	ROC = III	0.90		1.00
Lateral Displacement		N/A	1.00	1.00
Vertical Settlement		N/A	1.00	1.00
Global Stability Fill Walls	ROC= I, II	N/A	0.65	0.90 <sup>(1)</sup>
	ROC = III		0.75	1.00 <sup>(1)</sup>
Global Stability Cut Walls	ROC= I, II	N/A	0.60	0.90 <sup>(1)</sup>
	ROC = III		0.70	1.00 <sup>(1)</sup>

<sup>(1)</sup> Global stability analyses for Extreme Event I limit state that have resistance factors greater than specified require a displacement analysis to determine if it meets the performance limits presented in Chapter 10.

**Table 9-7, Resistance Factors for Flexible Gravity Retaining Walls**

Performance Limit		Limit States		
		Strength	Service	Extreme Event
Soil Bearing Resistance		0.65	N/A	1.00
Sliding Frictional Resistance		1.00	N/A	1.00
Lateral Displacement		N/A	1.00	1.00
Vertical Settlement		N/A	1.00	1.00
Global Stability Fill Walls	ROC= I, II	N/A	0.65	0.90 <sup>(1)</sup>
	ROC = III		0.75	1.00 <sup>(1)</sup>
Global Stability Cut Walls	ROC= I, II	N/A	0.60	0.90 <sup>(1)</sup>
	ROC = III		0.70	1.00 <sup>(1)</sup>

<sup>(1)</sup> Global stability analyses for Extreme Event I limit state that have resistance factors greater than specified require a displacement analysis to determine if it meets the performance limits presented in Chapter 10.

**Table 9-9, Resistance Factors for Embankments (Fill / Cut Section)**

Performance Limit		Limit States		
		Strength	Service	Extreme Event
Lateral Displacement		N/A	1.00	1.00
Vertical Settlement		N/A	1.00	1.00
Global Stability Embankment (Fill)	ROC= I, II	N/A	0.65	0.90 <sup>(1)</sup>
	ROC = III		0.75	1.00 <sup>(1)</sup>
Global Stability Cut Section	ROC= I, II	N/A	0.60	0.90 <sup>(1)</sup>
	ROC = III		0.70	1.00 <sup>(1)</sup>

<sup>(1)</sup> Global stability analyses for Extreme Event I limit state that have resistance factors greater than specified require a displacement analysis to determine if it meets the performance limits presented in Chapter 10.

**Table 9-10, Resistance Factors for Reinforced Soils**

Performance Limit		Limit States		
		Strength	Service	Extreme Event
Tensile Resistance of Metallic Reinforcement and Connectors <sup>(1)</sup>	Strip Reinforcement	0.75	N/A	1.00
	Grid Reinforcement <sup>(2)</sup>	0.65		0.85
Tensile Resistance of Geosynthetic Reinforcement And Connectors		0.90	N/A	1.20
Pullout Resistance of Tensile Reinforcement		0.90	N/A	1.20

<sup>(1)</sup> Apply to gross cross-section less sacrificial area. For sections with holes, reduce the gross area and apply to net section less sacrificial area.

<sup>(2)</sup> Applies to grid reinforcements connected to a rigid facing element (concrete panel or block). For grid reinforcements connected to a flexible facing mat or which are continuous with the facing mat, use the resistance factor for strip reinforcements.

The sixth paragraph of Section 16.8 of the *Manual* (Lateral Capacity) shall be deleted and replaced with the following:

Lateral designs for determining performance (deflections) are governed by the Service Limit State. The Strength Limit State is used in the determination of the lateral stability (critical depth) of the deep foundation. For group loadings using the P-y method of analysis, P-multipliers should be used in accordance with *AASHTO LRFD Bridge Design Specifications* Article 10.7 – Driven Piles.

In Appendix A of the *Manual*, Forms GDF 001 (Bridge Load Data Sheet), GDF 002 (Consultant Seismic Information Request), and GDF 003 (Consultant Geotechnical Seismic Response) shall be deleted and replaced with the attached forms dated July 22, 2010.

Please note these revisions in your copy of the *Manual*.

*Original Signed by Barry W. Bowers on July 22, 2010 for  
Preconstruction Support*

BWB:afg

Attachments

ec: Bridge Construction Engineer

Bridge Maintenance Engineer

FHWA Structural Engineer

File: PC/BWB

Preconstruction Support Managers

Regional Production Engineers

RPG Design Managers

## Bridge Load Data Sheet

PROJECT INFORMATION					
File No.		PCN:			
County:		Route:			
Description:					
Loads Provided By:			Date Loads Provided:		
Bridge Type:					
No. Spans /Lengths:		Width / No. Lanes:			
Edition of AASHTO LRFD Bridge Design Specifications:					
Edition of SCDOT Seismic Design Specifications for Highway Bridges:					
Bridge Operational Classification (OC):			Site Class:		
Seismic Design Category (SDC):			Scour Report Attached		
<i>Proposed Foundations (foundation type, size, and number per bent)</i>	End Bent				
	Interior Bent				
Location/Elev. of Applied Loads:		End Bent:		Int. Bent:	
Location/Elev. Est. Point of Fixity:		End Bent:		Int. Bent:	

## Bridge Load Data Sheet

	Limit State	Strength			Service		
	Load Cases:	Case 1FL (P=P <sub>max</sub> )	Case 2FL (V=V <sub>max</sub> )	Case 3FL (M=M <sub>max</sub> )	Case 1SL (P=P <sub>max</sub> )	Case 2SL (V=V <sub>max</sub> )	Case 3SL (M=M <sub>max</sub> )
End Bent - Longitudinal	P (kips) =						
	V (kips) =						
	M (ft-kip) =						
End Bent - Transverse	P (kips) =						
	V (kips) =						
	M (ft-kip) =						
Interior Bent - Longitudinal	P (kips) =						
	V (kips) =						
	M (ft-kip) =						
Interior Bent - Transverse	P (kips) =						
	V (kips) =						
	M (ft-kip) =						

	Limit State	Extreme Event I			Extreme Event II <sup>a</sup>			Extreme Event II <sup>b</sup>		
	Load Cases:	Case 1EL (P=P <sub>max</sub> )	Case 2EL (V=V <sub>max</sub> )	Case 3EL (M=M <sub>max</sub> )	Case 1EEL (P=P <sub>max</sub> )	Case 2EEL (V=V <sub>max</sub> )	Case 3EEL (M=M <sub>max</sub> )	Case 1EEL (P=P <sub>max</sub> )	Case 2EEL (V=V <sub>max</sub> )	Case 3EEL (M=M <sub>max</sub> )
End Bent - Longitudinal	P (kips) =									
	V (kips) =									
	M (ft-kip) =									
End Bent - Transverse	P (kips) =									
	V (kips) =									
	M (ft-kip) =									
Interior Bent - Longitudinal	P (kips) =									
	V (kips) =									
	M (ft-kip) =									
Interior Bent - Transverse	P (kips) =									
	V (kips) =									
	M (ft-kip) =									

Notes:

P – Axial; V – Shear; M – Moment; <sup>a</sup> – Check Flood w/o collision loads; <sup>b</sup> – Collision loads w/o check flood

## Consultant Seismic Information Request

PROJECT INFORMATION			
<b>File No.</b>	<b>PCN:</b>		
<b>County:</b>	<b>RPG<sup>1</sup>:</b>	<b>Route:</b>	
<b>Description:</b>			
<b>Latitude (4 decimals):</b> .	<b>Longitude (4 decimals):</b> .		
SEISMIC REQUEST			
<p>The SCDOT <u>Geotechnical Design Manual</u> and <u>Seismic Design Specifications for Highway Bridges</u>, latest editions, provide detailed seismic design requirements for transportation structures. The RPG Geotechnical Design Section (GDS) will be generating seismic design information from, <i>SCENARIO_PC</i>, the seismic analysis software. The consultant is encouraged to review the software documentation, <i>Information on Analysis Software</i>, for assistance in completing this form. The RPG GDS will be providing the pseudo-spectral acceleration (PSA) oscillator response for frequencies 0.5, 1.0, 2.0, 3.3, 5.0, 6.7 and 13 Hz, for 5% critical damping and peak horizontal ground acceleration (PGA) at either the <b>B-C Boundary</b> (Geologically Realistic) or <b>Hard Rock</b> Outcrop for specific project locations within South Carolina. The Geologically Realistic option is for sites in the Coastal Plain with sediment thickness greater than 100 feet to firm sediment (<math>V_s=2,500</math> feet per second (ft/s) or NEHRP B-C Boundary). Geologically Realistic conditions can also be encountered outside of the Coastal Plain where the sediment thickness is 100 feet or less above the basement rock and the <math>V_s = 8,000</math> ft/s. The Hard Rock Outcrop option is for an outcrop of hard rock (<math>V_s \geq 11,500</math> ft/s). The Preconstruction Support – Geotechnical Design Section (PCS/GDS) has developed a map to assist in determining the site condition. South Carolina has been divided in two zones, Zone I – Physiographic Units Outside of the Coastal Plain and Zone II – Physiographic Units of the Coastal Plain. This information can be provided for the Safety Evaluation Earthquake (SEE) 3% probability of exceedance for 75-year exposure periods or for the Functional Evaluation Earthquake (FEE) 15% probability of exceedance for 75-year exposure periods. The consultant is reminded that all embankment structures are required to be designed for both the SEE and FEE. The consultant will use this information in developing the Acceleration Design Response Spectrum (ADRS) in accordance with the SCDOT <u>Geotechnical Design Manual</u> and <u>Seismic Design Specifications for Highway Bridges</u>. The RPG GDS can also provide the Time Series for use in performing a Site-Specific Response Analysis.</p>			
STRUCTURE SEISMIC INFORMATION			
<b>Bridge Operational Classification (OC):</b>			
<b>Site Class:</b>			
<b>Bridge Seismic Level of Design:</b>			
Select Design Earthquake			
<b>SEE – 3% Probability of Exceedance in 75 years</b>	<input type="checkbox"/>		
<b>FEE – 15% Probability of Exceedance in 75 years</b>	<input type="checkbox"/>		
<b>Geologically Realistic</b> <input type="checkbox"/>		<b>Hard Rock Basement Outcrop</b> <input type="checkbox"/>	
Requestor Information			
<b>Requestor Name:</b>			
<b>Company Name:</b>			
<b>Phone Number:</b>	(     )     -		
<b>Email Address</b>			
<b>Request Date:</b>			

<sup>1</sup>RPG – Regional Production Group

**Lowcountry** – Beaufort, Berkeley, Charleston, Colleton, Dorchester, Hampton, Jasper

**Pee Dee** – Chesterfield, Clarendon, Darlington, Dillon, Florence, Georgetown, Horry, Kershaw, Lee, Marion, Marlboro, Sumter, Williamsburg

**Midlands** – Aiken, Allendale, Bamberg, Barnwell, Calhoun, Chester, Fairfield, Lancaster, Lexington, Newberry, Orangeburg, Richland, Union, York

**Upstate** – Abbeville, Anderson, Cherokee, Edgefield, Greenville, Greenwood, Laurens, McCormick, Oconee, Pickens, Saluda, Spartanburg

## Consultant Seismic Information Request

PROJECT INFORMATION				
<b>File No.</b>		<b>PCN:</b>		
<b>TIME SERIES GENERATION REQUEST</b>				
Time Series information is required if a Site-Specific Response Analysis is to be conducted. The SCDOT Geotechnical Design Manual requires a Site-Specific Response Analysis for Seismic Site Class "F". Unscaled and Scaled time series will be generated for the <b>B-C Boundary</b> in Shake91 data format. The Scaled time series are based on the earthquake magnitude ( $M_w$ ) and Epicentral distance provided.				
Request Time Series: Yes <input type="checkbox"/> No <input type="checkbox"/>				
<b>Sediment Thickness</b>				
The sediment thickness is used by <i>SCENARIO_PC</i> , to generate the time series simulation. The time series can be generated with the default sediment thickness as indicated in 2.2.2.1 <i>Site Response Modeling</i> of the <i>Seismicity Study Report</i> ( <a href="http://www.scdot.org/doing/pdfs/Reporttxt.pdf">http://www.scdot.org/doing/pdfs/Reporttxt.pdf</a> ) or can adjusted specifically for the geology and analysis requirements at the specific project location. This option only applies to those site were the Geologically Realistic Model is used.				
Change Sediment Thickness: Yes <input type="checkbox"/> meters No <input type="checkbox"/>				
<b>Match Entire Uniform Spectrum</b>				
In cases where the uniform hazard spectrum is dominated by a single scenario (a well defined modal event in the Deaggregation plots), the spectrum of the modal event may closely match that of the uniform hazard spectrum, even without much scaling. This will be the case for sites in the Coastal Plain near Charleston, for the 3% in 75 year hazard level. However, at sites where there are two or maybe 3 modes in the deaggregation, matching the entire spectrum with a single modal event will require much scaling. This scaling can be done automatically over the entire spectrum. Matching the entire spectrum involves a phase-invariant spectral scaling of the scenario time series. It is often preferable to use two or more modal events, each matching a specific frequency of the uniform hazard spectrum. This results in a simple constant (frequency independent) scaling of the scenario time series. If the consultant selects to not match the entire spectrum, the spectrum may be scaled using either an oscillator frequency/PSA or a PGA that will be matched when simulating the ground motion.				
<b>Match Entire Spectrum:</b>	Yes <input type="checkbox"/>	No <input type="checkbox"/>		
<b>If Not matching Entire Spectrum, Select PSA or PGA Scaling</b>	PSA Scaling <input type="checkbox"/>	<b>Scaling Parameter</b>	<b><math>M_{w1}</math></b>	<b><math>M_{w2}</math></b>
	PGA Scaling <input type="checkbox"/>	<b>Oscillator Frequency</b>	<b>Hertz</b>	<b>Hertz</b>
		PSA	<b>g</b>	<b>g</b>
		PGA	<b>g</b>	<b>g</b>
<b>Scenario Earthquake Magnitude and Distance</b>				
Determine earthquake magnitude, $M_w$ , and epicentral distance from the deaggregation plots provided by the U.S. Geological Survey ( <a href="http://eqint.cr.usgs.gov/deaggint/2002/index.php">http://eqint.cr.usgs.gov/deaggint/2002/index.php</a> ). The 3% and 15% in 75-year events are equivalent to the 2% and 10% in 50-year events, respectively.				
<b><math>M_{w1}</math> =</b>	<b>Epicentral Distance =</b>	Kilometers		
<b><math>M_{w2}</math> =</b>	<b>Epicentral Distance =</b>	Kilometers		

## Consultant Geotechnical Seismic Response

<b>To:</b>							
<b>Consultant:</b>							
<b>Date Requested:</b>							
PROJECT INFORMATION							
<b>File No.</b>				<b>PCN:</b>			
<b>County:</b>				<b>Route:</b>			
<b>Description:</b>							
<b>Latitude (4 decimals):</b>	.			<b>Longitude (4 decimals):</b>	.		
<b>Bridge Operational Classification (OC):</b>							
<b>Type of Seismic Information Requested:</b>							
<b>Site Class:</b>							
Pseudo-Spectral Acceleration (PSA)							
The SCDOT Geotechnical Design Section has generated the required Design Earthquake the pseudo-spectral acceleration (PSA) oscillator response for frequencies 0.5, 1.0, 2.0, 3.3, 5.0, 6.7 and 13 Hz, for 5% critical damping and peak horizontal ground acceleration (PGA) at the <b>B-C Boundary</b> .							
<b>SEE – 3% Probability of Exceedance in 75 years</b>							
PSA and PGA as Percentage of g							
0.5Hz	1.0Hz	2.0Hz	3.3Hz	5.0Hz	6.7Hz	13.0Hz	PGA
<b>Thickness of sediments:</b>		meters					
<b>FEE – 15% Probability of Exceedance in 75 years</b>							
PSA and PGA as Percentage of g							
0.5Hz	1.0Hz	2.0Hz	3.3Hz	5.0Hz	6.7Hz	13.0Hz	PGA
<b>Thickness of sediments:</b>		meters					
Time Series							
Unscaled and Scaled time series were generated for the <b>B-C Boundary</b> in Shake91 data format. The Scaled time series are based on the earthquake magnitude (Mw) and Epicentral distance requested.							
<b>The Time Series Files are Attached:</b>				Yes <input type="checkbox"/>		No <input type="checkbox"/>	
Design Response Spectrum							
<i>Two-Point Method</i>				<input type="checkbox"/>			
<i>Three-Point Method</i>				<input type="checkbox"/>			
<b>The Design Response Spectrum is Attached:</b>				Yes <input type="checkbox"/>		No <input type="checkbox"/>	
<b>Geotechnical Designer:</b>						<b>RPG<sup>1</sup>:</b>	
<b>Date:</b>						<b>Phone Number:</b> ( ) -	
<b>Geotechnical Review:</b>						<b>RPG<sup>1,2</sup>:</b>	

<sup>1</sup>RPG – Regional Production Group

**Lowcountry** – Beaufort, Berkeley, Charleston, Colleton, Dorchester, Hampton, Jasper

**Pee Dee** – Chesterfield, Clarendon, Darlington, Dillon, Florence, Georgetown, Horry, Kershaw, Lee, Marion, Marlboro, Sumter, Williamsburg

**Midlands** – Aiken, Allendale, Bamberg, Barnwell, Calhoun, Chester, Fairfield, Lancaster, Lexington, Newberry, Orangeburg, Richland, Union, York

**Upstate** – Abbeville, Anderson, Cherokee, Edgefield, Greenville, Greenwood, Laurens, McCormick, Oconee, Pickens, Saluda, Spartanburg

<sup>2</sup>RPG – Preconstruction Support – Geotechnical Design Section (PCS/GDS)





South Carolina  
Department of Transportation

**BRIDGE DESIGN MEMORANDUM – DM0410**

**TO:** RPG Structural Engineers  
Design Consultants

**DATE:** July 22, 2010

**RE:** *SCDOT Bridge Design Manual*  
Revisions to Chapter 6

Figures 6.3-5, 6.3-6, and 6.3-7 of the *SCDOT Bridge Design Manual* shall be deleted and replaced with the attached figures.

Please note these revisions in your copy of the *Manual*.

*Original Signed by Barry W. Bowers on July 22, 2010 for  
Preconstruction Support*

BWB:afg  
Attachment  
ec: Bridge Construction Engineer  
Bridge Maintenance Engineer  
FHWA Structural Engineer  
File: PC/BWB

Preconstruction Support Managers  
Regional Production Engineers  
RPG Design Managers



<b>Pile Bearing</b>	
	<b>One Pile</b>
Factored Design Load	70 tons
Geotechnical Resistance Factor	0.40
Nominal Resistance	175 tons
Estimated loss of Resistance due to Scour	20 tons
Estimated loss of Resistance due to Downdrag	10 tons
Required Driving Resistance	205 tons

*Note: Method of controlling installation of piles and verifying their capacity: Pile Installation Chart from Wave Equation analysis without stress measurements during driving.*

<b>Drivability Analysis</b>	
Skin Quake (QS)	0.10 in
Toe Quake (QT)	0.08 in
Skin Damping (SD)	0.20 s/ft
Toe Damping (TD)	0.15 s/ft
% Skin Friction	80%
Distribution Shape No.	1
Bearing Graph	Proportional
Toe No. 2 Quake	0.15 in
Toe No. 2 Damping	0.15 s/ft
End Bearing Fraction (Toe No. 2)	0.95
Pile Penetration	80%
Hammer Energy Range	25 – 60 ft-kips

### **PILE LOAD AND RESISTANCE TABLES**

**Figure 6.3-5**

<b>Drilled Shaft Bearing</b>	
Factored Design Load	370 tons
Factored Resistance – Side	370 tons
Factored Resistance – End	0
Geotechnical Resistance Factor – Side	0.50
Geotechnical Resistance Factor – End	0.50
Total Nominal Resistance	740 tons

**DRILLED SHAFT BEARING**

**Figure 6.3-6**

<b>Maximum Footing Reaction</b>	
Factored Design Load (includes 3 ft of backfill)	295 kips
Factored Net Bearing	4.6 ksf
Geotechnical Resistance Factor	0.45
Required Net Nominal Bearing Resistance	10.2 ksf

*Note: If footings of different types are used in the design, include a load table for each type of footing.*

**MAXIMUM FOOTING REACTIONS**

**Figure 6.3-7**

**BRIDGE DESIGN MEMORANDUM – DM0510**

**TO:** RPG Structural Engineers  
Design Consultants

**DATE:** October 22, 2010

**RE:** *SCDOT Geotechnical Design Manual*, Version 1.1  
Revisions to Chapter 21

Section 21.1 of the *SCDOT Geotechnical Design Manual* shall be updated by replacing the first bullet item, “Geotechnical Base Line Report,” with the following:

- Geotechnical Information Reports
  - a. Geotechnical Subsurface Data Report
  - b. Geotechnical Base Line Report

The following sentence shall be inserted at the beginning of the second paragraph of Section 21.1:

The Geotechnical Subsurface Data Report (GSDR) is used to convey geotechnical information on traditional design-bid-build projects.

Section 21.2 of the *Manual* shall be deleted and replaced with the following:

**21.2 GEOTECHNICAL INFORMATION REPORTS**

**21.2.1 Geotechnical Subsurface Data Report (GSDR)**

The GSDR is used to convey only geotechnical subsurface information for use by a contractor and is typically used with traditional design-bid-build projects. A GSDR does not provide any engineering interpretations or engineering analysis (preliminary or final). A GSDR shall include an introduction, a project description and any procedural variations from the field or laboratory testing methods as described in this Manual. The Appendices should at a minimum contain project and testing location plans, field exploration records (soil test boring logs, cone penetrometer and dilatometer records, etc.), and the results of all laboratory testing. Each field exploration record should contain the location of the testing and should correspond to the testing location plan. The laboratory testing results should clearly indicate the location and depth of each



sample on the test result. In addition, all laboratory testing results should be presented in a tabularized format as a summary, prior to the presentation of results of individual testing.

### **21.2.2 Geotechnical Base Line Report (GBLR)**

The GBLR is used to provide limited (preliminary) geotechnical information on a design-build project, thus permitting the contractor to bid on the project with a certain degree of knowledge and acceptable risk. A GBLR provides limited engineering interpretations or very preliminary engineering recommendations. The GBLR should be used in conjunction with project specific design-build criteria. The GBLR should contain at a minimum an introduction, project description, objective and scope of the geotechnical exploration and general recommendations concerning foundations and/or ground improvement requirements. A discussion of any procedural variations from the field or laboratory testing methods as described in this Manual shall also be included. The narrative portion of this type of report is anticipated to be relatively short, with the Appendices of the report being large. The Appendices should at a minimum contain project and testing location plans, field exploration records (soil test boring logs, cone penetrometer and dilatometer records, etc.), and the results of all laboratory testing. Each field exploration record should contain the location of the testing and should correspond to the testing location plan. Any guides used to interpret the data should also be included. The laboratory testing results should clearly indicate the location and depth of each sample on the test result.

Section 21.6 of the *Manual* shall be deleted and replaced with the following:

### **21.6 SUBMISSION REQUIREMENTS**

All reports submitted to SCDOT shall be signed and sealed by a Professional Engineer as required by South Carolina law. All preliminary and draft reports shall be submitted electronically. After reviews have been completed, one bound, color copy of each final report shall be submitted along with a CD containing an electronic copy (.pdf). Electronic copies shall also be in color and include all Appendices. The CD containing the electronic copy shall be labeled to include the name of the project, the route or road number, the SCDOT file number, and the name of the geotechnical consulting firm. The CD shall also be labeled as preliminary or final and shall indicate whether the copy is draft or revised.

Please note these revisions in your copy of the *Manual*.

To assist contractors during their bid preparation, the Geotechnical Subsurface Data Report will be placed on the SCDOT Construction Extranet website along with the project plans and proposal.

*Original Signed by N. Peter Yeh on October 22, 2010 for  
Preconstruction Support*

NPY:afg

ec: Bridge Construction Engineer

Bridge Maintenance Engineer

FHWA Structural Engineer

File: PC/BWB

Preconstruction Support Managers

Regional Production Engineers

RPG Design Managers

**BRIDGE DESIGN MEMORANDUM – DM0111**

**TO:** RPG Structural Engineers  
Design Consultants

**DATE:** March 7, 2011

**RE:** Drilled Shafts – Revisions to Sections 12.5.3.2, 15.3.1.2, 19.3.3, and 20.3.2.1 of the *SCDOT Bridge Design Manual* and Sections 16.4 and 22.2.1.2 of the *SCDOT Geotechnical Design Manual*

To address some recent issues involving drilled shaft construction, Sections 12.5.3.2, 15.3.1.2, 19.3.3, and 20.3.2.1 of the *SCDOT Bridge Design Manual* and Sections 16.4 and 22.2.1.2 of the *SCDOT Geotechnical Design Manual* shall be revised as described in the following paragraphs.

In Section 12.5.3.2 of the *SCDOT Bridge Design Manual*, the second sentence of the first paragraph shall be deleted.

Figure 15.3-2 in Section 15.3.1.2 of the *SCDOT Bridge Design Manual* shall be revised to require a 4-inch minimum concrete cover for drilled shafts in both soil and rock conditions. This minimum cover must be provided to the transverse reinforcement.

In Section 19.3.3 of the *SCDOT Bridge Design Manual*, Item 5 shall be deleted and Items 1 and 2 shall be deleted and replaced with the following:

1. Location of Top of Shaft. The top of drilled shafts should be set at the higher of either the ground line or 5 feet above the water elevation expected during construction. Typically, the tops of drilled shafts within a bent are set at the same elevation. Also, the elevations of the tops of shafts from bent to bent are usually set at the same elevation in water and in flat land areas such as floodplains. If the distance from the top of a shaft to the bottom of a bent cap is less than 5 feet, the Contractor should be given the option, at no additional cost to SCDOT, of extending the shaft to the bottom of the bent cap.
2. Casing for Shafts. Unless approved otherwise by the Regional Production Engineer, all shafts shall be detailed with construction casing. The portion of the shaft below the bottom of the casing, whether in soil or rock, shall be detailed with a diameter that is six inches smaller than the diameter of the



construction casing. To provide a construction tolerance, the bridge design shall include provisions for allowing the top and bottom of casing to be raised or lowered 2 feet. The casing shall not be considered in the determination of the structural resistance of the shaft. However, it should be considered when evaluating the seismic response of the foundation because the casing will provide additional resistance.

In Section 20.3.2.1 of the *SCDOT Bridge Design Manual*, the second paragraph shall be deleted and replaced with the following:

Where supported on drilled shafts, a minimum of 3 inches should be detailed from the edge of shaft to the edge of column at the column/shaft interface. If the column supported on a drilled shaft would be less than 5 feet tall, the Contractor should be given the option, at no additional cost to SCDOT, of extending the shaft to the bottom of the bent cap. On projects with large water elevation fluctuations, provide for permissible construction joints in casings and shafts to facilitate construction. Detail the permissible construction joint in the shaft a minimum of 2 feet below the permissible construction joint in the casing.

In Section 16.4 of the *SCDOT Geotechnical Design Manual*, the second paragraph shall be deleted and replaced with the following:

Drilled shaft sizes (diameters) can range from 30 inches (2-1/2 feet) to 144 inches (12 feet). Drilled shaft sizes typically used by SCDOT range from 42 inches (3-1/2 feet) to 84 inches (7 feet) in diameter. Drilled shaft diameters should be a minimum of 6 inches larger than the column above the shaft. Unless approved otherwise by the Regional Production Engineer, all shafts shall be detailed with construction casing. The portion of the shaft below the bottom of the casing, whether in soil or rock, shall be detailed with a diameter that is six inches smaller than the diameter of the construction casing.

In Section 22.2.1.2 of the *SCDOT Geotechnical Design Manual*, the first paragraph shall be deleted and replaced with the following:

The following Plan Notes apply to drilled shafts. Drilled shafts are typically used at interior bents only, but Plan Notes are also required if drilled shafts are used at end bents. The geotechnical designer typically determines the bottom elevation of the casing. In dry environments, the top of casing elevation should be set at the ground line. In wet or fluctuating water environments, the top of casing elevation should be set 5 feet above the water elevation expected during construction. If the column supported on a drilled shaft would be less than 5 feet tall, the Contractor



should be given the option, at no additional cost to SCDOT, of extending the shaft to the bottom of the bent cap. The designer shall also provide for permissible construction joints in casings to facilitate construction on projects with large water elevation fluctuations. The notes and tables included herein are generic in nature and should be made project specific. Underlined capital letters are used to indicate areas where project specific information is required. In addition, when the tables presented herein include numbers, these numbers shall be changed to the requirements of specific projects.

The above revisions shall apply to all projects where the substructure design has not been substantially completed.

*Original Signed by James W. Kendall, Jr.  
on March 7, 2011*

James W. Kendall, Jr.  
Preconstruction Support Engineer

JWK:rga  
ec: Bridge Construction Engineer  
Bridge Maintenance Engineer  
FHWA Structural Engineer  
File:PC/BWB

Preconstruction Support Managers  
Regional Production Engineers  
RPG Design Managers

**BRIDGE DESIGN MEMORANDUM – DM0211**

**TO:** RPG Structural Engineers  
Design Consultants

**DATE:** July 7, 2011

**RE:** *SCDOT Geotechnical Design Manual*, Version 1.1  
Revisions to Chapters 4, 8, 9, 10, and 17

The first paragraph of Section 4.3 of the *SCDOT Geotechnical Design Manual* shall be amended by inserting the following sentence between the fifth and sixth sentences:

Any requests to deviate from these minimum requirements shall be made in writing and shall be forwarded to the PCS/GDS for consideration. All testing shall be to a sufficient depth to effectively evaluate the appropriate limit state conditions and shall fully penetrate any formation that will affect performance (e.g., settlement or slope instability of a roadway embankment or roadway structure).

The paragraph in Section 4.3.3 of the *Manual* shall be deleted and replaced with the following paragraph:

All roadway embankments shall have one testing location at least every 500 feet along the roadway embankment. In addition, roadway embankments within 150 feet of a bridge end shall have a minimum of two testing locations; one at the bridge end (which is also used for bridge foundation design) and one at a point 150 feet from the bridge end. The testing location 150 feet from the bridge end must be to a depth that is sufficient to effectively evaluate Extreme Event I limit state for the roadway embankment design.



Table 8-11 of the *Manual* shall be deleted and replaced with the following table:

**Table 8-11, Roadway Structure Operational Classification (ROC)**

Roadway Structure Operational Classification (ROC)	Description
<b>I</b>	Roadway embankments located within 150 feet of a bridge with OC = I. Roadway structures located within 150 feet of a bridge with OC = I. Rigid walls with heights greater than 15 feet. Flexible walls with heights greater than 50 feet.
<b>II</b>	Roadway embankments located within 150 feet of a bridge with OC = II. Structures (not classified as ROC = I) located within 150 feet of a bridge with OC = II.
<b>III</b>	Roadway embankments located within 150 feet of a bridge with OC = III. Structures (not classified as ROC = I) located within 150 feet of a bridge with OC = III. Structures (not classified as ROC = I) located more than 150 feet from a bridge.
<b>IV</b>	Roadway embankments located more than 150 feet from a bridge.

Chapters 9 and 10 of the *Manual* shall be amended to include a Roadway Structure Operational Classification (ROC) = IV. All embankments classified as ROC = IV shall be designed and evaluated for the strength and service limit states. Unless approved otherwise by the Director of Preconstruction, embankments classified as ROC = IV shall only be designed and evaluated for Extreme Event I limit state when all of the following conditions exist:

- The embankment is a causeway (i.e., an embankment constructed over marshy land or in water).
- The embankment is located on a route that has no detour.
- The embankment is located on a route having a current ADT that equals or exceeds 3000 vpd.

The resistance factors (Chapter 9) and performance limits (Chapter 10) for embankments classified as ROC = IV shall be the same as the requirements for embankments classified as ROC = III.

Section 10.2.2 of the *Manual* shall be amended by inserting the following paragraph between the second and third paragraphs:

The Service and Damage Level descriptions in Tables 10-1 and 10-2 are intended to apply to bridges and roadway structures other than embankments. Because soils found in-place and within embankments may significantly vary within short distances both vertically and horizontally due to South Carolina geology, it is difficult to associate closure time and degree of collapse along a continuous embankment. Generally, it is not economically feasible to entirely prevent failure of an embankment due to a seismic event. Observations from past earthquakes around the world indicate that embankment failures are isolated and discontinuous after a seismic event and the accessible area along the top of the embankment has for the most part remained traversable. Based on these observations, embankments that are not designed for seismic events should still be traversable even though they may exhibit significant damage that will require repair.

The paragraph and table (Table 10-27) in Section 10.7.2.1 of the *Manual* shall be deleted and replaced with the following paragraph:

The Performance Objective for embankments at Extreme Event I limit state is that the embankments remain stable during the seismic design event. For embankments adjacent to structures, this objective is based on the potential for the embankments to contribute to the collapse of the structure should the embankments fail.

In Section 17.1 of the *Manual*, the third paragraph shall be deleted and replaced with the following:

Embankments with heights less than 3 feet and slopes of 2H:1V or flatter generally do not require stability analysis. However, for all embankment heights, the calculated settlement values must conform to the applicable performance limits.

These revisions shall apply to all projects where design has not been substantially completed.

*Original Signed by James W. Kendall, Jr.  
on July 7, 2011*

James W. Kendall, Jr., P.E.  
Preconstruction Support Engineer

JWK:afg

ec: Bridge Construction Engineer  
Bridge Maintenance Engineer  
FHWA Structural Engineer

File:PC/BWB

Preconstruction Support Managers  
Regional Production Engineers  
RPG Design Managers

**BRIDGE DESIGN MEMORANDUM – DM0311**

**TO:** RPG Structural Engineers  
Design Consultants

**DATE:** December 14, 2011

**RE:** Diaphragms for Prestressed Concrete Beams – Revisions to Sections 15.5.7 and 17.3.6 of the *SCDOT Bridge Design Manual*

The first paragraph of Section 15.5.7 of the *SCDOT Bridge Design Manual* shall be deleted and replaced with the following paragraph:

For prestressed beam spans, cast-in-place concrete diaphragms shall be used at all supports with the beams embedded a minimum of 3 in into the diaphragm. For spans greater than 40 ft, intermediate diaphragms shall also be used. If the lowest elevation of the span (at the bottom flange of beam) is 20 MSL or above, the intermediate diaphragms may be constructed of either cast-in-place concrete or structural steel. If the lowest elevation of the span is below 20 MSL, the intermediate diaphragms must be constructed of cast-in-place concrete. Structural steel diaphragms must be detailed as presented in the *SCDOT Bridge Design Drawings and Details* (available at the SCDOT website). At a minimum, one line of intermediate diaphragms shall be detailed at the centerline of each span having a length greater than 40 ft but less than 100 ft, and two lines of intermediate diaphragms shall be detailed at the third points of each span having a length greater than or equal to 100 ft. For skews of 20° or less, the intermediate diaphragms may be placed along the skew of the bridge. For skews in excess of 20°, the intermediate diaphragms shall be placed perpendicular to the beams. The tops of the intermediate concrete diaphragms should be detailed 3 in below the tops of the beams. For spans with intermediate concrete diaphragms, the slabs shall not be poured until a minimum of seven days after the diaphragms are poured or until the diaphragm concrete reaches a compressive strength of 3 ksi.

In Item 3 of Section 17.3.6 of the *Manual*, the last sentence of the second bullet item shall be deleted and replaced with the following sentence:

Unless required by design, intermediate diaphragms may be omitted in the staging bay of prestressed concrete beams.



These revisions shall apply to all projects where design and detailing have not been substantially completed.

*Original Signed by James W. Kendall, Jr.  
on December 14, 2011*

James W. Kendall, Jr., P.E.  
Preconstruction Support Engineer

JWK:afg

ec: Bridge Construction Engineer  
Bridge Maintenance Engineer  
FHWA Structural Engineer

File:PC/BWB

Preconstruction Support Managers  
Regional Production Engineers  
RPG Design Managers

**BRIDGE DESIGN MEMORANDUM – DM0112**

**TO:** RPG Structural Engineers  
Design Consultants

**DATE:** February 14, 2012

**RE:** Mechanically Stabilized Earth (MSE) Walls

The *SCDOT Bridge Drawings and Details* have been updated to include details for Mechanically Stabilized Earth (MSE) walls. Additionally, a Supplemental Technical Specification, SC-M-713, has been developed to address requirements for design, materials, fabrication, and construction of MSE walls. The details and specification can be accessed on the Department's website. The Department's MSE wall design policies and practices can be found in Chapter 18 and Appendix C of the *SCDOT Geotechnical Design Manual*.

The new details and specification shall be incorporated into all projects having MSE walls, where the design and detailing of the MSE walls have not been substantially completed.

*Original Signed by James W. Kendall, Jr.  
on February 14, 2012*

James W. Kendall, Jr., P.E.  
Preconstruction Support Engineer

JWK:afg  
ec: Bridge Construction Engineer  
Bridge Maintenance Engineer  
FHWA Structural Engineer  
File:PC/BWB

Preconstruction Support Managers  
Regional Production Engineers  
RPG Design Managers





South Carolina  
Department of Transportation

**BRIDGE DESIGN MEMORANDUM – DM0212**

**TO:** RPG Structural Engineers  
Design Consultants

**DATE:** July 12, 2012

**RE:** *SCDOT Bridge Design Manual*  
Revisions to Sections 21.2.1.8 and 21.2.1.9

Delete the first paragraph in Section 21.2.1.8 of the *SCDOT Bridge Design Manual* and replace it with the following:

Bearing plates used at integral bents shall have the same plan dimensions as the leveling pad. For other types of bents, the bearing plate shall be at least 1 inch wider than the elastomeric bearing on which the plate rests. Bearing plates shall satisfy the edge distances given in Figure 21.2-3.

Delete the paragraph in Section 21.2.1.9 of the *Manual* and replace it with the following:

A plain elastomeric pad shall be detailed under the bearing plate of beams at integral bents to provide a level and uniform bearing surface. The plan dimensions of the pad shall match the plan dimensions of the bearing plate and the thickness shall be a minimum of ¼ inch. Structural grout is not an acceptable substitute.

Please note these revisions in your copy of the *Manual*.

James W. Kendall, Jr., P.E.  
Preconstruction Support Engineer

JWK:afg

ec: Bridge Construction Engineer  
Bridge Maintenance Engineer  
FHWA Structural Engineer

File: PC/BWB

Preconstruction Support Managers  
Regional Production Engineers  
RPG Design Managers







South Carolina  
Department of Transportation

## BRIDGE DESIGN MEMORANDUM – DM0312

**TO:** RPG Structural Engineers  
Design Consultants

**DATE:** November 28, 2012

**RE:** Prestressed Concrete Pile Connection Details  
Revisions to Section 19.2.6.3, Section 20.1.2, Figure 20.1-1, and Section 20.2.7.1  
of the *SCDOT Bridge Design Manual*

The University of South Carolina recently completed a research project that investigated the behavior of SCDOT's typical detail for the connection of prestressed concrete piles to cast-in-place bent caps. The final report for this research project, Project 672 – Behavior of Pile to Bent Cap Connections Subjected to Seismic Forces, can be viewed at <http://www.clemson.edu/t3s/scdot/completed%20test.htm>.

Findings of the research indicate that modifications are needed to SCDOT's current pile cap connection details for prestressed concrete piles. *SCDOT Bridge Drawings and Details* Drawings 704-01 and 704-02 have been updated to incorporate the recommended embedment requirements. In addition, please update your copy of the *SCDOT Bridge Design Manual* as noted below.

Delete Item 3 in Section 19.2.6.3 of the *SCDOT Bridge Design Manual* and replace with the following:

3. Prestressed Concrete Piles. The piles should be connected to the caps or footings by embedding the piles an equivalent of 1.3 pile widths. No roughening of the pile is required. However, the pile surface to be embedded shall be clean and free of any laitance prior to placement of the cap or footing concrete.

The pile should be oriented in the caps or footings such that the "top side" of the pile experiences the smaller moment demand. The "top side" is the top surface of the pile when it was poured in the casting bed.

To allow for constructability, the pile embedment length should have a tolerance of  $\pm 3$  in. Unless approved otherwise by the Regional Production Engineer, the pile embedment into the cap shall not be less than 12 in.



Delete the last sentence in Section 20.1.2 of the *Manual* and replace with the following sentence:

The minimum depths shall be increased as necessary to accommodate the pile embedment.

Add the following three paragraphs to Section 20.1.2 of the *Manual*:

For pile bents, the end and side clearances from piles to the surface of the cap should be considered during design to ensure that design forces will not cause the pile to break out of the sides or ends of the pile cap.

For pile bents supporting slab superstructures, the minimum bent cap depth should be 32 in for 18-in square prestressed concrete piles. For pile bents with piles larger than 18-in square, maximum pile embedment may dictate that deeper pile caps be used for constructability and due to the effects of punching shear. For pile bents supporting beams, regardless of pile size, the effects of punching shear shall be investigated.

The length of prestressed concrete pile bent caps should be set to provide a minimum overhang that is the equivalent of 2 pile widths.

Revise Figure 20.1-1 of the *Manual* to require a minimum cap width of 3'-4" for 20-in square prestressed concrete piles and a minimum cap width of 4'-0" for 24-in square prestressed concrete piles.

Delete Item 4 in Section 20.2.7.1 of the *Manual*.

These revisions apply to all projects where design has not advanced beyond the preliminary design phase.



James W. Kendall, Jr., P.E.  
Preconstruction Support Engineer

JWK:afg  
ec: Bridge Construction Engineer  
Bridge Maintenance Engineer  
FHWA Structural Engineer  
Materials and Research Engineer  
File:PC/BWB

Preconstruction Support Managers  
Regional Production Engineers  
RPG Design Managers



South Carolina  
Department of Transportation

**BRIDGE DESIGN MEMORANDUM – DM0113**

**TO:** RPG Structural Engineers  
Design Consultants

**DATE:** June 5, 2013

**RE:** Bicycle Rail Height  
Revision to Section 17.6.3 of the *SCDOT Bridge Design Manual*

Delete Section 17.6.3 of the *SCDOT Bridge Design Manual* and replace with the following:

**17.6.3 Bicycle Rails**

Reference: LRFD Article 13.9

Section 12.6 discusses the conditions for which bicycle accommodation is required across a bridge. Where bicycle accommodation is required, a bicycle rail that meets the geometric and loading requirements of LRFD Article 13.9 must be provided. The height of the bicycle railing shall not be less than 42.0 in, measured from the top of the riding surface. There are some locations where a barrier height above the minimum should be considered. See the *AASHTO Guide for the Development of Bicycle Facilities* for guidance.

Apply these updated requirements to all projects where design has not advanced beyond the preliminary design phase.

*Original Signed by James W. Kendall, Jr.  
on June 5, 2013*

James W. Kendall, Jr., P.E.  
Preconstruction Support Engineer

JWK:afg  
ec: Bridge Construction Engineer  
Bridge Maintenance Engineer  
FHWA Structural Engineer  
File:PC/BWB

Preconstruction Support Managers  
Regional Production Engineers  
RPG Design Managers



**BRIDGE DESIGN MEMORANDUM – DM0213**

**TO:** RPG Structural Engineers  
Design Consultants

**DATE:** July 29, 2013

**RE:** Vehicular Collision Force and Bent Protection  
Section 13.3.2.7 of the *SCDOT Bridge Design Manual*

Section 13.3.2.7 of the *SCDOT Bridge Design Manual* applies for bridges designed in accordance with the fifth or earlier editions of the AASHTO *LRFD Bridge Design Specifications (LRFD Specifications)*. For designs utilizing later editions of the *LRFD Specifications*, use the following requirements in lieu of those specified in Section 13.3.2.7.

Bents located within a distance of 30 ft to the edge of a roadway should have provisions for redirecting or absorbing a collision load in accordance with the *LRFD Specifications*. If this is not practical, the bent shall be designed with either:

- a minimum of three columns. Each column in the bent must have a solid reinforced concrete cross section with a minimum diameter of three ft and a maximum column spacing of 20 ft; **or**
- solid reinforced concrete pier walls having a minimum thickness of 2.5 ft and a length of 20.0 ft; solid, reinforced concrete single columns having a minimum of 4.0 ft by 12.5 ft dimensions; or any other solid reinforced concrete sections having an minimum cross sectional area of 50 ft<sup>2</sup> and a minimum thickness of 2.5 ft.

In addition, bents located within a distance of 30 ft to the edge of a roadway that do not have provisions for redirecting or absorbing a collision load shall be designed for a collision force in accordance with the *LRFD Specifications* unless site conditions qualify for exemption. When investigating whether site conditions qualify for exemption, assume that any bridge having an Operational Classification of I or II for seismic design considerations is classified as “Critical or Essential” and determine the ADTT based on the design year traffic data on the lower roadway. In addition, any bridge crossing a highway on the Interstate system, US 17, US 378 from SC 441 east to I-95, I-20 Spur from I-95 east to US 76, or US 76 from I-20 Spur east to North Carolina



shall also be considered as “Critical or Essential” for the purposes of collision protection.

The collision force specified by the *LRFD Specifications* may be considered as a point load on the column, with no distribution of force due to frame action within the bent, foundation, and superstructure. When determining the point of application of the load on the column, assume that the finished ground elevation may be two feet lower or higher than what is detailed on the plans. For the vehicle collision load combination, the column may be designed for shear only, assuming failure along two shear planes inclined at 45 degree angles above and below the point of force application. Further analysis of the foundation elements, footing, and bent cap is not required. Because this is an extreme event load combination, a resistance factor of 1.00 may be utilized.

Interior bents adjacent to a railroad track that are located 25 ft to 50 ft from the centerline of the railroad track shall be designed with either:

- a minimum of three columns. Each column in the bent must have a solid reinforced concrete cross section with a minimum diameter of three ft and a maximum column spacing of 20 ft; **or**
- solid reinforced concrete pier walls having a minimum thickness of 2.5 ft and a length of 20.0 ft; solid, reinforced concrete single columns having a minimum of 4.0 ft by 12.5 ft dimensions; or any other solid reinforced concrete sections having an minimum cross sectional area of 50 ft<sup>2</sup> and a minimum thickness of 2.5 ft.

*Original Signed by James W. Kendall, Jr.  
on July 29, 2013*

James W. Kendall, Jr., P.E.  
Preconstruction Support Engineer

JWK:afg

ec: Bridge Construction Engineer  
Bridge Maintenance Engineer  
FHWA Structural Engineer

File:PC/BWB

Preconstruction Support Managers  
Regional Production Engineers  
RPG Design Managers



South Carolina  
Department of Transportation

## **BRIDGE DESIGN MEMORANDUM – DM0114**

**TO:** RPG Structural Engineers  
Design Consultants

**DATE:** January 31, 2014

**RE:** Jointless Bridges  
Sections 12.2.4.1, 12.2.8, 12.4.2.2, 12.4.2.5, 12.7.8, 17.4.2, 20.2.7.2, 21.1.1.1, and 21.1.1.10 and Figure 21.1-1 of the *SCDOT Bridge Design Manual*

Sections 12.2.4.1, 12.2.8, 12.4.2.2, 12.4.2.5, 12.7.8, 17.4.2, 20.2.7.2, 21.1.1.1, and 21.1.1.10 and Figure 21.1-1 of the *SCDOT Bridge Design Manual* are hereby revised to address maintenance issues that SCDOT has experienced with jointless bridges. Most of the maintenance issues have occurred in the coastal region of the State and most involve erosion at the approach slab/approach roadway interface when deck drainage was omitted due to environmental restrictions or at grade separations where open deck drainage could not be detailed. Additionally, problems have occurred when sleeper slabs were constructed in stages. Although jointless bridges offer structural benefits, site-specific conditions such as deck drainage restrictions, staged construction, and varying soil conditions can sometimes make it preferable to detail bridges with expansion joints. Please update your copy of the *Manual* as noted below.

### **Delete Section 12.2.4.1 and replace with the following:**

#### **12.2.4.1 General**

Jointless bridges offer structural benefits and should be considered in design when practical. However, there are sometimes site-specific conditions that make it preferable to detail bridges with expansion joints in lieu of detailing a jointless bridge. Joints can be eliminated with special consideration to:

- load path;
- gravity and longitudinal loads;
- effects of concrete creep and shrinkage;
- effects of temperature variations;
- stability of superstructure and substructure during construction and service;
- effects of staged construction;



- effects of skew and curvature;
- the superstructure-end bent-foundation connection design and details;
- effects of superstructure and substructure stiffness;
- effects of settlement and earth pressure;
- effects of varying soil properties and type of foundation; and
- effects of approach slab and its connection to the bridge and interaction with the approach roadway.

In addition to the considerations listed above, the designer should consult with the appropriate District Maintenance Engineer to determine if there are additional regional considerations that should be made.

**Delete Section 12.2.8 and replace with the following:**

**12.2.8 Sleeper Slabs**

A sleeper slab is a foundation slab, inverted tee-beam, or L-beam placed transversely to the roadway to support the end of the approach slab away from the bridge. Sleeper slabs should be used to provide an off-bridge joint at the end of the approach slab, where:

- a jointless bridge exceeds 240 ft total length for steel girder bridges or 300 ft total length for prestressed concrete beam bridges;
- the distance from an integral or semi-integral end bent to the nearest expansion joint exceeds 240 ft for steel girder bridges or 300 ft for prestressed concrete beam bridges; or
- an integral or semi-integral end bent is used and the end of approach slab interfaces with a moment slab and railing.

Sleeper slabs shall be used when an integral or semi-integral end bent is used and the roadway pavement is constructed of concrete.

Sleeper slabs shall not be used when staged construction is required or when a future widening is anticipated.

The embankment beneath the sleeper slab shall be designed to prevent differential settlement along the length of the sleeper slab.

**Delete the sixth paragraph of Section 12.4.2.2 and replace with the following paragraph:**

A jointless flexible end bent, either integral or semi-integral, is preferred. However, free-standing end bents shall be used where the roadway approach pavement is constructed of concrete and either staged construction is required or a future widening is anticipated. Free-standing end bents shall also be used where the anticipated translational movements of the piles are too great. The force effects of these displacements shall be included in the design.

**Delete the first sentence of the second paragraph of Section 12.4.2.5 and replace with the following sentence:**

Use free-standing end bents where integral and semi-integral end bents cannot accommodate the anticipated translational movements or where the roadway approach pavement is constructed of concrete and either staged construction is required or a future widening is anticipated.

**In Section 12.7.8, insert the following sentence after the second sentence of Item 1:**

However, due to site conditions, jointless bridges may not always be appropriate.

**In Section 17.4.2, delete the second sentence of Item 6 and replace it with the following two sentences:**

Where asphalt pavement is used for the approaching roadway and sleeper slabs are not detailed, approach slabs shall be constructed 2 in below grade. If sleeper slabs are detailed, approach slabs shall be constructed at grade.

**In Section 20.2.7.2, delete Item 2 and replace it with the following:**

2. Loads/Forces. The following steps should be considered in the analysis of integral or semi-integral end bents:
  - Establish the point of zero superstructure movement by considering the elastic resistance of all substructures and bearing devices.
  - Consider the effects of creep, shrinkage, and temperature.



- Assume that the longitudinal movement at any point along the superstructure is proportional to its distance to the point of zero superstructure movement. For example, the longitudinal movement at a point 50 ft from the point of zero movement should be considered to be one-half of the horizontal movement at a point 100 ft from the point of zero movement.
- Neglect the lateral curvature of the superstructure if it satisfies the provisions of LRFD Article 4.6.1.2.
- Distribute the vertical force effects in the end bents among the piles based upon static equilibrium as axial loads.
- Consider the lateral soil resistance in establishing the force effects and buckling resistance of piles.
- Combine the force effects in accordance with the provisions of LRFD Article 3.4.1.

**In Section 21.1.1.1, insert the following sentence after the first sentence of Item 1:**

However, due to site conditions, jointless bridges may not always be appropriate.

**Modify Figure 21.1-1 by deleting "and Sleeper Slabs" from the Usage column of the Silicone Rubber Sealant row.**

**In Section 21.1.1.10, delete the second sentence and replace it with the following sentence:**

SCDOT practice is to use this system for joints of cored slab bridges.

The above revisions apply to all projects where design has not advanced beyond the preliminary design phase.



James W. Kendall, Jr., P.E.  
Preconstruction Support Engineer

JWK:afg  
ec: Bridge Construction Engineer  
Bridge Maintenance Engineer  
FHWA Structural Engineer  
File:PC/BWB

Preconstruction Support Managers  
Regional Production Engineers  
RPG Design Managers

**BRIDGE DESIGN MEMORANDUM – DM0214**

**TO:** RPG Structural Engineers  
Design Consultants

**DATE:** March 18, 2014

**RE:** Revised Labeling of Bridge Plans

With the implementation of the new Project Programming System (P2S), the Department has begun assigning a Project ID to each project. The Project ID replaces the File Number that the Department has historically used for project identification.

Include the Project ID in the title information on the title sheet of the bridge plans and include a Bridge Plans ID on each sheet of the plans. The Bridge Plans ID consists of the seven-digit Project ID that is generated by P2S followed by a dash and then the suffix B01. On projects with multiple sets of bridge plans, the suffix is increased by one (i.e. B02, B03, etc.) on subsequent sets of plans.

The *SCDOT Bridge Drawings and Details* will be updated to reflect this new plans identification policy. In the title information of the title sheet, File Number will be replaced with Project ID. In the upper right corner of the sheet, the PCN block will be replaced with a Bridge Plans ID block. The File Number block in the title block of the standard drawing border sheet will be removed and a Bridge Plans ID block will be placed in the upper right corner of the sheet. The Total Sheets block will be removed from both the title sheet and the standard drawing border sheet.

In addition to the new project identification changes indicated above, a new information block has been added in the lower left corner of the title sheet. For plans of replacement bridges, include the Asset ID of the existing bridge in this block. For new bridges that are not replacing existing bridges, an Asset ID will not be available at the time of plans production. In this case, insert “Not Assigned” in the block.

Attached are templates of the title sheet and standard border sheet that show the changes. Effective with the June 2014 Letting, ensure that all bridge plans include the new Project ID labels. For plan sets that have already been printed and signed, create a new title sheet in accordance with this memo. All other sheets may be corrected by carefully and legibly hand



writing the Bridge Plans ID in the upper right corner of the sheet. If sheets are corrected in this manner, update all CADD files so future prints will have the correct information on the sheet.

A Contract ID is also generated by P2S when a project is added to a letting. When multiple projects are combined into a single contract, each of the projects will share the same Contract ID. Do not add the Contract ID to the plans. Before the plans are uploaded into the Department's Plans Library system, the Engineering Reproduction Services office will place a Contract ID watermark stamp on the electronic copy of the title sheet of each set of plans.

*Original Signed by James W. Kendall, Jr.  
on March 18, 2014*

James W. Kendall, Jr., P.E.  
Preconstruction Support Engineer

JWK:afg  
Attachments  
ec: Bridge Construction Engineer  
Bridge Maintenance Engineer  
FHWA Structural Engineer  
File:PC/BWB

Preconstruction Support Managers  
Regional Production Engineers  
RPG Design Managers

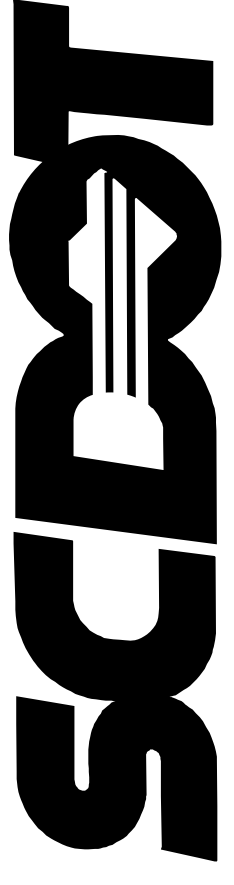

South Carolina Department of Transportation

# PROPOSED PLANS FOR

# COUNTY PROJECT ID ROUTE REPLACE BRIDGE OVER

### INDEX OF SHEETS

- Title Sheet
- Summary of Estimated Quantities
- General Notes
- General Details
- Reinforcing Bending Details

Note to Designer:  
 Consultant to provide contact information for review of shop plans, including mailing address and telephone number of office responsible for review of shop plans.

Submit Shop Plans to:  
 Insert Name of Consulting Firm  
 Insert Mailing Address  
 Telephone: (XXX) XXX-XXXX

Approximate Location of Bridge is  
 Latitude XX° XX' - XX"  
 Longitude XX° XX' - XX"

SCDOT REVIEW	FOR CONSTRUCTION INITIAL	DATE
PRECONSTRUCTION SUPPORT - ROAD		
PRECONSTRUCTION SUPPORT - STRUCTURES		
RPG - DESIGN MANAGER		
RPG - PROGRAM MANAGER		

THE INITIALS ABOVE DO NOT RELIEVE THE ENGINEER OF RECORD OF THE RESPONSIBILITY TO DESIGN THIS PROJECT IN ACCORDANCE WITH ALL APPLICABLE CRITERIA.

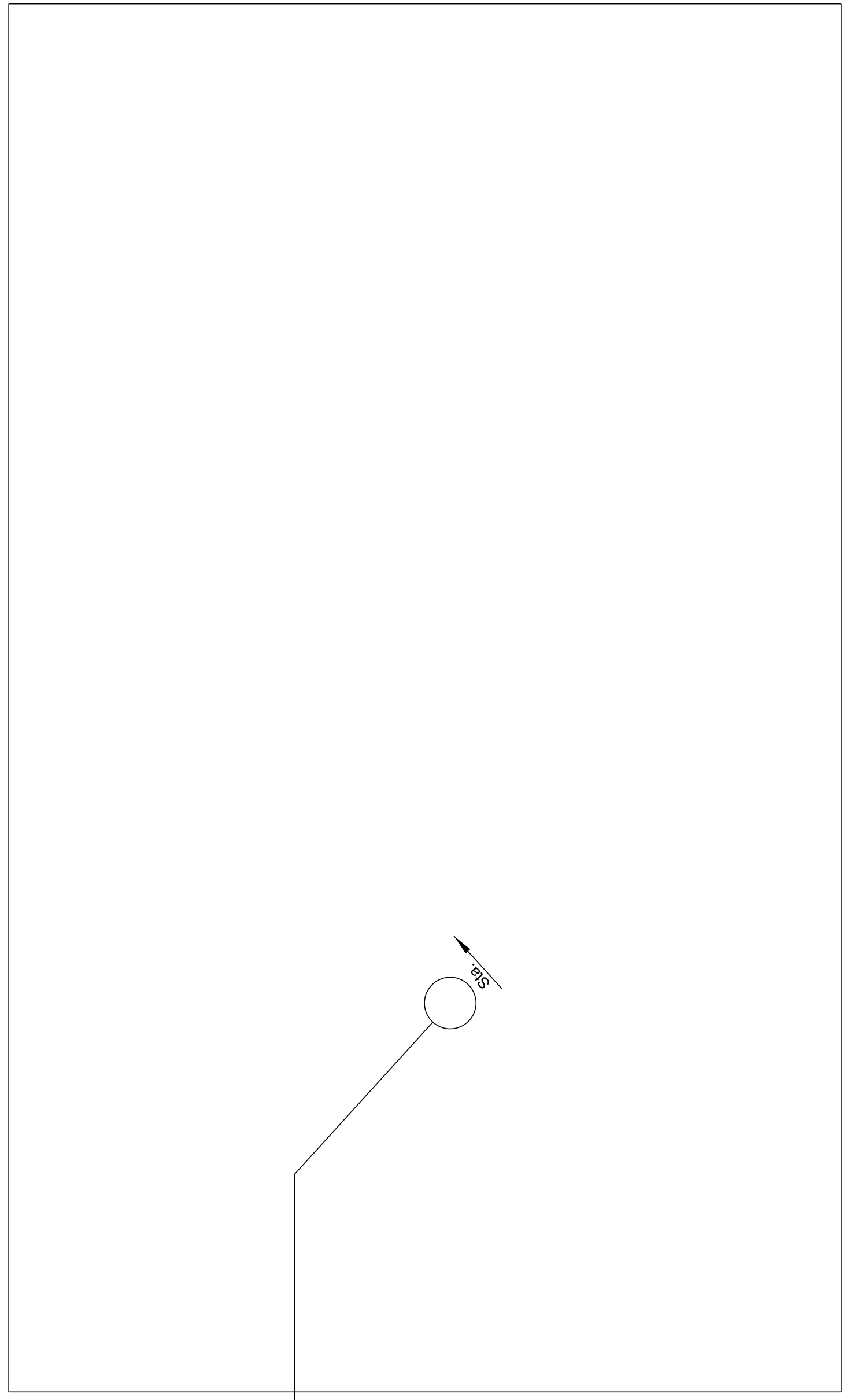
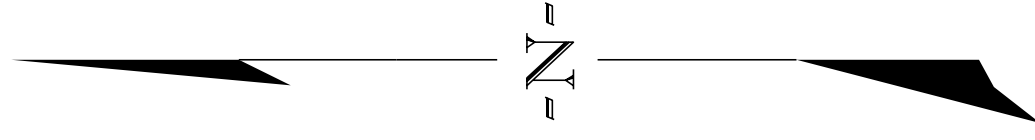

SITE LOCATION

### LAYOUT

NET LENGTH OF ROADWAY	X.XXX	MILES
NET LENGTH OF BRIDGES	X.XXX	MILES
NET LENGTH OF PROJECT	X.XXX	MILES
LENGTH OF EXCEPTIONS	X.XXX	MILES
GROSS LENGTH OF PROJECT	X.XXX	MILES

Note to Designer:  
 If plans are for a replacement bridge, insert the Asset ID of the existing bridge. For new bridges insert "Not Assigned".

3 DAYS BEFORE DIGGING IN SOUTH CAROLINA  
**CALL 811**  
 SOUTH CAROLINA 811 (SC811)  
 WWW.SC811.COM  
 ALL UTILITIES MAY NOT BE A MEMBER OF SC811

ASSET ID \_\_\_\_\_ XXXX \_\_\_\_\_

TRAFFIC DATA  
 \_\_\_\_\_ XXXX ADT \_\_\_\_\_ XXXX V.P.D.  
 \_\_\_\_\_ XXXX ADT \_\_\_\_\_ XXXX V.P.D.  
 TRUCKS \_\_\_\_\_ XX \_\_\_\_\_ %;

CONSULTING ENGINEERING FIRM

ENGINEER OF RECORD

FOR CONSTRUCTION: \_\_\_\_\_ DATE \_\_\_\_\_

NOTE:  
 EXCEPT AS MAY OTHERWISE BE SPECIFIED ON THE PLANS OR IN THE SPECIAL PROVISIONS, ALL MATERIALS AND WORKMANSHIP ON THIS PROJECT SHALL CONFORM TO THE SOUTH CAROLINA DEPARTMENT OF TRANSPORTATION STANDARD SPECIFICATIONS FOR HIGHWAY CONSTRUCTION (2007 EDITION) AND THE STANDARD DRAWINGS FOR ROAD CONSTRUCTION IN EFFECT AT THE TIME OF LETTING.

REVIEWED	XXX
DR.	XXX
BY	CHK
DATE	XX-XX



**BRIDGE DESIGN MEMORANDUM – DM0314**

**TO:** RPG Structural Engineers  
Design Consultants

**DATE:** December 12, 2014

**RE:** Construction Joint Requirements

On *SCDOT Bridge Drawings and Details* Drawings 700-04 and 700-05, the Construction Joint Detail note has been updated as follows:

Before making subsequent pour, wait either a minimum of 96 hours after placement of the initial pour or until the initial pour concrete has attained a minimum of 75% of the specified 28-day compressive strength as verified by testing extra cylinders.

Effective with the May 2015 Letting, ensure that all bridge plans include this updated note.

In addition, please update your copy of the *SCDOT Bridge Design Manual* by deleting the third sentence of the fifth paragraph of Section 17.3.5.1 and replacing it with the following sentence:

The final pours shall include the negative-moment regions and shall not be placed until either a minimum of 96 hours has elapsed after placement of the adjacent pour or the adjacent pour concrete has attained a minimum of 75% of the specified 28-day compressive strength.

*Original Signed by James W. Kendall, Jr.  
on December 12, 2014*

James W. Kendall, Jr., P.E.  
Preconstruction Support Engineer

JWK:afg  
ec: Bridge Construction Engineer  
Bridge Maintenance Engineer  
FHWA Structural Engineer  
File:PC/BWB

Preconstruction Support Managers  
Regional Production Engineers  
RPG Design Managers



**BRIDGE DESIGN MEMORANDUM – DM0115**

**To:** RPG Structural Engineers  
Design Consultants

**Date:** November 3, 2015

**Re:** SCDOT Seismic Design Specifications for Highway Bridges, Version 2.0  
Revisions to Section 3, Section 6, Section 7, Section 8 and Section 9.

**Apply these updated requirements to all projects where design has not advanced beyond the preliminary design phase.**

**REVISIONS TO SECTION 3**

**3.6 SEISMIC DEMAND:** Delete second paragraph and replace it with:

Displacement demand can be obtained from a Multimode Spectral Analysis (MSA). Section 5 covers displacement demand modeling and computations.

**Table 3.6 Bridge System Seismic Displacement Performance Limits:** Delete this table.

**3.11 DESIGN REQUIREMENTS FOR TEMPORARY BRIDGES AND STAGED CONSTRUCTION:** Delete last paragraph and replace it as follows:

The following applies to widening of existing bridges. If the bridge has been seismically designed using the 2001 Seismic Design Specifications for Highway Bridges or the 2008 Seismic Design Specifications for Highway Bridges, the widened section shall be designed to meet the same seismic performance requirements as the existing bridge. For widening of existing bridges that were not seismically designed using the above specifications, seismic design requirements are determined on a case-by-case basis by the Regional Production Engineer.

**3.12 DESIGN REQUIREMENTS FOR PEDESTRIAN BRIDGES:** Delete subsection and replace it with the following:

**3.12 DESIGN REQUIREMENTS FOR NON-HIGHWAY BRIDGES**

Pedestrian bridges over roads carrying vehicular traffic shall satisfy OC III performance objectives as indicated in Table 3.3. Pedestrian bridges owned or maintained by the Department or located within Department right-of-way will also satisfy the OC III performance objectives.

Railroad bridges over roads carrying vehicular traffic shall satisfy the requirements of AREMA Chapter 9 for life safety and any other AREMA or railroad specific requirements.

Utility bridges over roads carrying vehicular traffic shall satisfy OC III performance objectives.



**REVISIONS TO SECTION 6**

**6.2 DEFINITION OF PLASTIC HINGES:** Replace equation (6-3) with:

$$L_p = D^* + 0.08H' \leq 1.5D^*$$

**6.4 PLASTIC HINGE ACCESSIBILITY:** Delete the last paragraph and replace it with the following:

The key to forcing the plastic hinge above ground with the oversized drilled shaft is placing the transverse reinforcement in the shaft at a larger diameter than the column framing into the shaft. Providing a larger diameter of transverse reinforcement increases the area of confined concrete in the region. Oversized shafts shall be at least 24 inches larger than the diameter of the column framing into the shaft. Column longitudinal reinforcement shall extend into oversized shafts in a staggered manner as shown in Figure 6.2.

**Figure 6.2 Typical and Oversized Drilled Shafts:** Delete figure and replace it with the following:

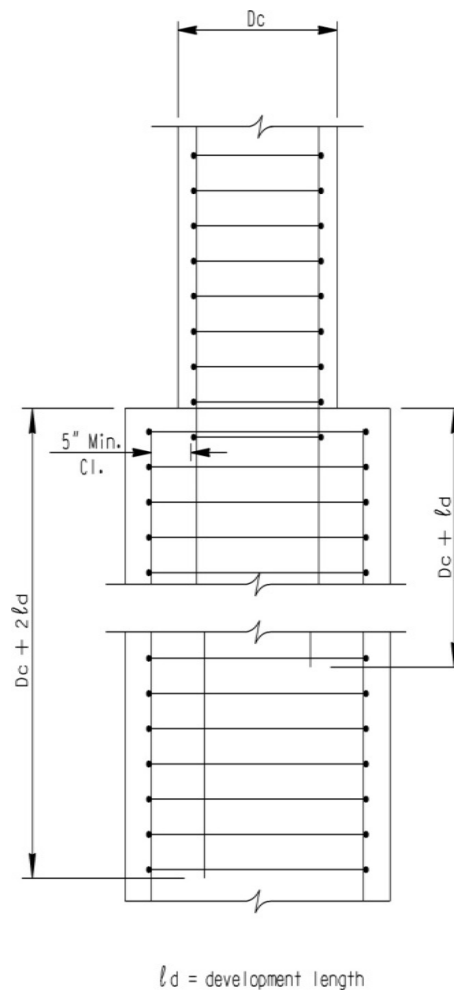

**Figure 6.2 Oversized Drilled Shaft**



**6.5.2 Member Displacement Capacity:** Delete equation (6-6) and replace it with the following:

$$\Delta_y = \frac{1}{3} \phi_y (L + L_{sp})^2 \quad \text{Where } L_{sp} = 0.15 f_{ye} d_{bl}$$

$L_{sp}$  = Strain Penetration

Delete equation (6-17) and replace it with the following:

$$\Delta_{y1} = \frac{1}{3} \phi_{y1} (L_1 + L_{sp})^2$$

Delete equation (6-18) and replace it with the following:

$$\Delta_{y2} = \frac{1}{3} \phi_{y2} (L_2 + L_{sp})^2$$

**6.6.5 Confined Concrete Model:** Delete equation (6-46) and replace it with the following:

$$\epsilon_{ccu} = 0.004 + \frac{1.4 f_{yh} \rho_s \epsilon_{su}^R}{f'_{cc}}$$

## REVISIONS TO SECTION 7

**7.1.3 Ductility Capacity:** Delete subsection and replace it with the following:

### **7.1.3 Local Member Ductility Capacity**

Local displacement ductility capacity of a member is defined using Equations 7-3a or 7-3b.

$$\mu_c = \frac{\Delta_c}{\Delta_y} \text{ for Free Head condition} \quad (7-3a)$$

$$\mu_{c1} = \frac{\Delta_{c1}}{\Delta_{y1}} \ \& \ \mu_{c2} = \frac{\Delta_{c2}}{\Delta_{y2}} \text{ for Fixed Head condition} \quad (7-3b)$$

Where:

$\mu_c$	Ductility capacity (dimensionless).	See Figure 6.3.
$\mu_{c1}$	Ductility capacity of first cantilever (dimensionless).	See Figure 6.4.
$\mu_{c2}$	Ductility capacity of second cantilever (dimensionless).	See Figure 6.4.

Member displacement capacity is defined in Section 6.5.2. Each ductile member shall have a minimum local displacement ductility capacity of 3; ( $\mu_c \geq 3$ , or  $\mu_{c1} \geq 3$  and  $\mu_{c2} \geq 3$ ; see equations 7-3a and 7-3b) to ensure dependable rotational capacity in the plastic hinge regions regardless of the displacement demand imparted to that member.

The minimum displacement ductility capacity of 3 may be difficult to achieve for columns and drilled shafts with large diameters ( $D > 10$  ft.), or components with large L/D ratios. Local displacement ductility capacities less than 3 require the approval of the RPG Structural Engineer in consultation with the Structural Design Support Engineer.

**Table 7.1 Substructure Unit Quantitative Damage Criteria  
(Maximum Ductility Demand  $\mu_d$ ):**

Delete table and replace it with the following:

**Table 7.1 Substructure Unit Quantitative Damage Criteria  
(Maximum Ductility Demand  $\mu_d$ )**

Bridge System		Design Earthquake	Operational Classification (OC)		
			I	II	III
<b>Superstructure</b>		<b>FEE</b>	1.0	1.0	See Note
		<b>SEE</b>	1.0	1.0	1.0
<b>Substructure</b>	<b>Prestressed Concrete Pile Interior Bents</b>	<b>FEE</b>	1.0	2.0	See Note
		<b>SEE</b>	2.0	4.0	4.0
	<b>Prestressed Concrete Pile End Bents</b>	<b>FEE</b>	1.0	2.0	See Note
		<b>SEE</b>	2.0	4.0	4.0
	<b>Single Column Bents</b>	<b>FEE</b>	1.0	2.0	See Note
		<b>SEE</b>	2.0	3.0	4.0
	<b>Multi Column Bents</b>	<b>FEE</b>	2.0	3.0	See Note
		<b>SEE</b>	4.0	6.0	6.0
	<b>Pier Walls Weak Axis</b>	<b>FEE</b>	2.0	3.0	See Note
		<b>SEE</b>	3.0	5.0	5.0
	<b>Pier Walls Strong Axis</b>	<b>FEE</b>	1.0	1.0	See Note
		<b>SEE</b>	1.0	1.0	1.0

Note: Analysis for FEE is not required for OC III bridges.

## **REVISIONS TO SECTION 8**

**8.4.9 Minimum Development Length of Longitudinal Column Reinforcement Extended into Oversized Shafts:** Delete subsection and replace it with the following:

### **8.4.9 Minimum Development Length of Longitudinal Column Reinforcement Extended into Oversized Shafts**

Longitudinal column reinforcement shall be extended into oversized shafts in a staggered manner with the minimum embedment lengths of  $(D_c + l_d)$  and  $(D_c + 2l_d)$  where  $D_c$  is the cross sectional dimension of the column and  $l_d$  is the tension development length of the longitudinal column reinforcement. See Figures 6.2 and 8.4.

**Figure 8.4 Reinforcement for Column on Oversized Drilled Shaft:** Delete figure and replace it with the following:

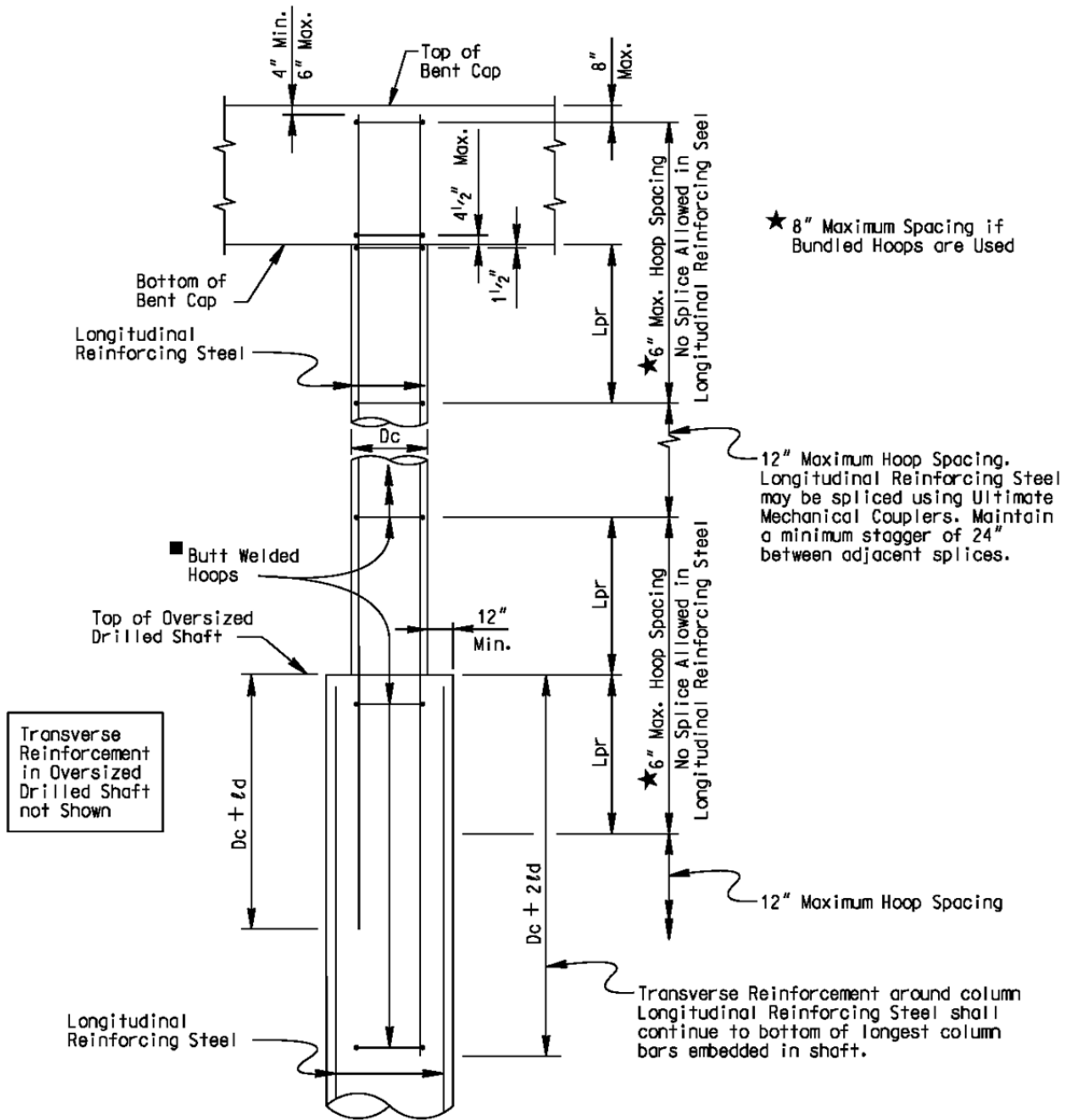

■ Hoops shall have butt welded splices. The minimum size shall be #19 (#6) and the maximum size shall be #25 (#8). To prevent the hoop weld splices from being located on the same vertical plane, the locations of the splices shall be staggered around the perimeter of the column by a minimum distance of 1/3 of the hoop circumference.

**Figure 8.4 Reinforcement for Column on Oversized Drilled Shaft**

Note: Shaft transverse reinforcement does not have the same diameter as the column transverse reinforcement.

**REVISIONS TO SECTION 9**

**9.2.2 Concrete Superstructure Shear Key Design:** Add the following as the first paragraph:

Shear keys shall be provided at bents with expansion joints, except as noted in except for SDC A bridges.

**9.2.3 Steel Superstructure Shear Key Design:** Add the following as the first paragraph:

Shear keys shall be provided at bents with expansion joints, except as noted in except for SDC A bridges.

**Please note these revisions in your copy of the SCDOT Seismic Design Specifications for Highway Bridges.**

---

James W. Kendall, Jr., P.E.  
Preconstruction Support Engineer

JWK:afg  
ec: Bridge Construction Engineer  
Bridge Maintenance Engineer  
FHWA Structural Engineer

Preconstruction Support Managers  
Regional Production Engineers  
RPG Design Managers  
Design Build Engineer

File:PC/TK

## BRIDGE DESIGN MEMORANDUM – DM0120

**TO:** RPG Structural Design Engineers  
RPG Roadway Design Engineers  
Structural Design Consultants  
Roadway Design Consultants

**DATE:** February 21, 2020

**RE:** Roadway Widths and Geometric Layout of Prestressed Concrete Cored Slab Bridges

**Apply these updated requirements to all projects where design has not advanced beyond the preliminary plan acceptance.**

Due to prestressed concrete cored slab bridge unit widths being fixed at 3'-0", the roadway widths for bridges constructed of cored slabs do not exactly match the approach roadway widths detailed in the typical sections of the roadway plans.

The table below provides minimum allowable widths of cored slab bridges for common two-lane roadway sections on tangent alignment.

Approach Roadway Width	Bridge Roadway Width	Bridge Width Out-to-Out	Number of Cored Slab Units per Span	Approach Roadway Lane Width	Approach Roadway Shoulder Width	Bridge Shoulder Width
28'-0"	27'-10"	30'-0"	10	10'-0"	4'-0"	3'-11"
34'-0"	33'-10"	36'-0"	12	11'-0"	6'-0"	5'-11"
40'-0"	39'-10"	42'-0"	14	12'-0"	8'-0"	7'-11"
44'-0"	45'-10"	48'-0"	16	12'-0"	10'-0"	10'-11"

Cored slab bridges shall be constructed on tangent alignments. The use of skewed chorded spans to create horizontal curves on the bridge will not be allowed.

For other combinations of approach roadway widths when sidewalks are not present, the minimum shoulder bridge widths on cored slab bridges shall be no more than 1" narrower than the shoulder widths on the approach roadway, and shall not be less than 4'-0". Shoulder widths for cored slab bridges built on a tangent alignment, but, with a horizontal curve on the roadway



across the bridge, shall also be no more than 1" narrower than the shoulder widths on the approach roadway, and shall not be less than 4'-0".

For cored slab bridges where sidewalks are used, the bridge roadway width shall comply with the requirements of the SCDOT Roadway Design Manual.



Terry B. Koon, P.E.  
Structural Design Support Engineer

TBK:hl

ec:

John Boylston, Director of Preconstruction  
Robbie Isgett, Director of Construction  
David Cook, Director of Maintenance  
Robert Perry, Director of Traffic Engineering  
Chris Gaskins, Design Build Engineer  
Ladd Gibson, Director of Mega Projects  
Rob Bedenbaugh, Preconstruction Support Engineer  
File: PC/TBK/HL

Jennifer Necker, RP Engineer - Lowcountry  
Leah Quattlebaum, RP Engineer - Pee Dee  
Philip Sandel, RP Engineer - Midlands  
Julie Barker, RP Engineer - Upstate  
Tad Kitowicz, FHWA  
Blake Gerken, FHWA







South Carolina  
Department of Transportation

## **BRIDGE DESIGN MEMORANDUM – DM0220**

**TO:** RPG Structural Engineers  
Design Consultants

**DATE:** May 8, 2020

**RE:** Revision to SCDOT Bridge Design Manual

**Apply these updated requirements to all projects where design has not advanced beyond the preliminary design phase.**

The attached table provides revisions to the *SCDOT Bridge Design Manual* in order to bring it up to compliance with the *AASHTO LRFD Bridge Design Specifications*, 8<sup>th</sup> Edition. Additionally, other minor non-AASHTO LRFD related revisions were made to update the Bridge Design Manual.

**Please note the changes below in your copy of the *SCDOT Bridge Design Manual*.**

Terry B. Koon, P.E.  
Structural Design Support Engineer

TBK:hl

ec:

John Boylston, Director of Preconstruction  
Robbie Isgett, Director of Construction  
David Cook, Director of Maintenance  
Robert Perry, Director of Traffic Engineering  
Chris Gaskins, Design Build Engineer  
Rob Bedenbaugh, Precon. Support Engineer  
David Rister, Acting Director of Mega Projects

Jennifer Necker, RP Engineer - Lowcountry  
Leah Quattlebaum, RP Engineer – Pee Dee  
Philip Sandel, RP Engineer - Midlands  
Julie Barker, RP Engineer – Upstate  
Tad Kitowicz, FHWA  
Blake Gerken, FHWA

File: PC/TBK/HL



**List of changes to SCDOT Bridge Design Manual**

<b>SCDOT SECTION #</b>	<b>BDM</b>	<b>LINE # (omit if full section)</b>	<b>OLD contents (omit if all inclusive)</b>	<b>changed to</b>
12.6.1.3		1	48H:1V (2.08%)	50H:1V (2%)
12.6.1.3		3,7,12	2.08%	2.00%
12.6.1.3		9	to 36H:1V (2.78%)	per SCDOT Roadway Design Manual
12.6.1.6		14	bike lanes will have a cross slope of 24H:1V (4.16%).	See SCDOT Roadway Design Manual for bike lanes cross slope
12.6.1.6		15	48H:1V (2.08%).	50H:1V (2%)
Figure 12.6.3 - 12.6.7			48H:1V	50H:1V
13.1.2.1		1		Reference: LRFD Articles 3.4 and 3.5
13.1.2.2		4		Reference: LRFD Articles 3.6 and 3.11
13.1.3.1				Reference: LRFD Article 1.3.2.1
13.3.2.4				See LRFD Article 3.4.1
14.3		1,3	LRFD Article 5.7.3.5	LRFD Article 5.6.3.4
15.1.2		1	LRFD Article 5.7	LRFD Article 5.6
15.1.2		3	LRFD Article 5.7.2.2	LRFD Article 5.6.2.2
15.1.2		4	LRFD Article 5.7.3.2.5	LRFD Article 5.6.3.2.5
15.1.2		5	LRFD Article 5.7.3.2.1	LRFD Article 5.6.3.2.1
15.1.3.1				Delete entire Section (Referenced Article Deleted from AASHTO)
15.1.3.2				Reference: LRFD Article 5.6.3.3
15.1.4		1	LRFD Article 5.8	LRFD Article 5.7
15.1.4		11	LRFD Article 5.6.3	LRFD Article 5.8.2
15.1.4		12	LRFD Article 5.13.2	Delete Reference (Referenced Article Deleted from AASHTO)
15.1.4		13	LRFD Article 5.8.3	LRFD Article 5.7.3
15.1.4		16	LRFD Eq. 5.8.3.3-1	LRFD Eq. 5.7.3.3-1
15.1.4		17	LRFD Eq. 5.8.3.3-2	LRFD Eq. 5.7.3.3-2
15.1.4		19	LRFD Equation 5.8.3.3-2	LRFD Equation 5.7.3.3-2
15.1.4		22	LRFD Eq. 5.8.3.3-3	LRFD Eq. 5.7.3.3-3
15.1.4		24	LRFD Eq. 5.8.3.3-4	LRFD Eq. 5.7.3.3-4
15.1.4		32	LRFD Article 5.8.3.4.2	LRFD Article 5.7.3.4.2
15.1.4		33	LRFD Article 5.8.2.5	LRFD Article 5.7.2.5
15.1.4		34	LRFD Table 5.8.3.4.2-1	LRFD Equation 5.7.3.4.2-1
15.1.4		35	LRFD Table 5.8.3.4.2-2	LRFD Equation 5.7.3.4.2-2
15.1.4		36	LRFD Article 5.8.3.4	LRFD Article 5.7.3.4
15.1.4		39	LRFD Eq. 5.8.2.4-1	LRFD Eq. 5.7.2.3-1

**List of changes to SCDOT Bridge Design Manual (continued)**

15.1.4	41	LRFD Eq. 5.8.2.5-1	LRFD Eq. 5.7.2.5-1
15.1.4	44	LRFD Article 5.8.3.2	LRFD Article 5.7.3.2
15.1.4	46	LRFD Article 5.8.3.5	LRFD Article 5.7.3.5
15.1.4	50	LRFD Article 5.8.2	LRFD Article 5.7.2
15.1.4	50	LRFD Article 5.8.3.6	LRFD Article 5.7.3.6
15.1.5	1	LRFD Article 5.6.3	LRFD Article 5.8.2
15.1.7	1	LRFD Article 5.7.3.4	LRFD Article 5.6.7
15.2.2	2	ASTM A 706	AASHTO M 31, Type W
15.3.1.2	1	LRFD Article 5.12.3	LRFD Article 5.10.1
15.3.1.5	4	bridge decks	bridge decks and their appurtenances; including barrier parapets, railing walls, raised medians, and sidewalks.
15.3.1.5	14, 15		Add the following sentence to the end of the paragraph: "Steel studs, Stirrups or diaphragm reinforcement extended into the decks are not considered as deck reinforcement.",
15.3.1.6.1			See Bridge Design Memo DM0320
15.3.1.6.3			See Bridge Design Memo DM0320
Figure 15.3-4			See Bridge Design Memo DM0320
Figure 15.3-5			See Bridge Design Memo DM0320
Figure 15.3-6			See Bridge Design Memo DM0320
15.3.1.7			See Bridge Design Memo DM0320
15.3.1.7.2			See Bridge Design Memo DM0320
15.3.1.7.4			See Bridge Design Memo DM0320
15.3.1.7.6			See Bridge Design Memo DM0320
15.3.1.8	1	LRFD Articles 5.11.2.3 and 5.11.5.2.1	LRFD Articles 5.10.8.2.3 and 5.10.8.4.2a
15.4.1	1	LRFD Article 5.14.4	LRFD Article 5.12.2
15.4.1.4	1	LRFD Articles 5.7.3.3.2, 5.10.8, and 5.14.4.1	LRFD Articles 5.6.3.3, 5.10.6, and 5.12.2.1
15.4.1.4	4	LRFD Articles 5.7.3.3.2 and 5.10.8	LRFD Articles 5.6.3.3 and 5.10.6
15.4.1.4	7	LRFD Article 5.14.4.1	LRFD Article 5.12.2.1
15.4.1.4	10	LRFD Equation 5.14.4.1-1	LRFD Equation 5.12.2.1-1
15.4.2	1	LRFD Article 5.7.3.6.2	LRFD Article 5.6.3.5.2
15.4.2	7-8		Camber for the dead-load deflection of the span shall be 1/8 in for concrete flat slab spans 22 ft in length, 3/16 in for concrete flat slab spans 30 ft in length, and 3/8 in for concrete flat slab spans 40 ft in length.
15.4.4	1	LRFD Article 5.14.4.1	LRFD Article 5.12.2.1
15.4.5	1	LRFD Articles 5.6.2 and 5.10.8	LRFD Articles 5.5.1.1 and 5.10.6
15.4.5	2-6		Deleted

**List of changes to SCDOT Bridge Design Manual (continued)**

Figure 15.4-1			Deleted
15.4.6	8	LRFD Article 5.11.1.2	LRFD Article 5.10.8.1.2
15.4.9	1	LRFD Article 5.14.4.1	LRFD Article 5.12.2.1
15.4.11	1,2	LRFD Article 5.11.1.2	LRFD Article 5.10.8.1.2
15.4.11	4	LRFD Article 5.11.1.2.3	LRFD Article 5.10.8.1.2c
15.5.3.1	1,3	LRFD Article 5.9.4	LRFD Article 5.9.2.3
15.5.3.3	17	LRFD Article 5.9.4	LRFD Article 5.9.2.3
15.5.3.4	1	LRFD Article 5.9.5	LRFD Article 5.9.3
15.5.3.5	1	LRFD Article 5.11.4	LRFD Article 5.9.4.3
15.5.3.5	10	LRFD Equation 5.11.4.2-1	LRFD Equation 5.9.4.3.2-1
15.5.3.5	13	LRFD Article 5.11.4.3	LRFD Article 5.9.4.3.3
15.5.6.4	1	LRFD Article 5.8.4	LRFD Article 5.7.4
15.5.6.4	2-10		Delete the Section and use referenced LRFD Article above
15.5.7	1	LRFD Article 5.13.2.2	LRFD Article 5.12.4
16.2.1.3.5	3	ASTM A325	ASTM F3125 (for Grade A325)
16.2.1.5	2	LRFD Table 6.6.2-1	LRFD Table 6.6.2.1-2
16.2.2	3	A325 (Type 1)	ASTM F3125, Grade A325 (Type 1)
16.2.2	4	A325 (Type 3)	ASTM F3125, Grade A325 (Type 3)
16.4			See LRFD Article 6.6.1
16.7.1	3,4	A325 (Type 3)	ASTM F3125, Grade A325 (Type 3)
16.7.1	4	A325 (Type 1)	ASTM F3125, Grade A325 (Type 1)
17.1.2	1,3	LRFD Article 5.12	LRFD Article 5.14
17.4.2	14, 15	For flat slabs and cored slabs, the bottom reinforcing steel that is parallel to the roadway shall be #7 bars at 6 in on center.	For flat slabs and cored slabs, the bottom reinforcing steel that is parallel to the roadway shall be #9 bars at 6 in on center.
17.4.2	19, 20	All approach slabs shall be doweled to the end bent or pavement rest with #6 bars at 12 in on center.	All approach slabs shall be doweled to the end bent or pavement rest with #6 bars minimum at 12 in on center.
17.5.1	7	LRFD Article 5.8.4	LRFD Article 5.7.4
19.2.4	1	LRFD Articles 10.7.1.10, 10.7.1.11, and 10.7.1.12	SCDOT Geotechnical Design Manual

**List of changes to SCDOT Bridge Design Manual (continued)**

19.2.4	4-9	Piles shall be a minimum of 10 ft in length. At end bents, if the depth to suitable rock strata is less than 10 ft, typical practice is to drive the piles in holes cored in the rock and backfill with Class 4000 DS Concrete. A minimum core depth of 5 ft into scour-resistant rock is recommended. The minimum tip elevation shall reflect the elevation where the required ultimate pile capacity can be obtained, the penetration required to resist lateral pile loads, and the penetration of any overlying unsuitable soil strata, as specified in LRFD Article 10.7.1.11.	Piles shall be a minimum of 10 ft in length. At end bents, if the depth to suitable rock strata is less than 10 ft, typical practice is to drive or place the piles in holes cored in the rock and backfilled with Class 4000 DS Concrete. A minimum core depth of 5 ft into scour-resistant rock is recommended. The minimum tip elevation shall reflect the elevation where the required ultimate pile capacity can be obtained, the penetration required to resist lateral pile loads, and the penetration of any overlying unsuitable soil strata, as specified in the SCDOT Geotechnical Design Manual.
19.2.6.2	1	LRFD Article 10.7.1.5	LRFD Article 10.7.1.2
19.2.6.7	1,2	Minimum spacing requirements are not related to group effect. Group effects are specified in LRFD Articles 10.7.3.7.3 and 10.7.3.10.	Reference: SCDOT Geotechnical Design Manual
19.2.6.10	1	LRFD Article 10.7.1.13	SCDOT Geotechnical Design Manual
19.2.6.11	1	LRFD Article 10.7.1.14	SCDOT Geotechnical Design Manual
19.3.2	1-4	The LRFD Specifications provides procedures to estimate the axial resistance of drilled shafts in cohesive soils and cohesionless soils in LRFD Articles 10.8.3.3 and 10.8.3.4, respectively. In both cases, the resistance is the sum of the shaft and tip resistances. LRFD Article 10.8.3.5 discusses the determination of axial resistance of drilled shafts in rock.	Reference: SCDOT Geotechnical Design Manual
19.3.3	10	LRFD Article 5.7.4.4	LRFD Article 5.6.4.4
19.3.3	10-12	If the drilled shaft is extended above ground to form an interior bent or part of a bent, it should be analyzed and designed as a column.	If a drilled shaft is extended above ground, above the scour line, or through liquefiable soil, structurally design the shaft as a column and detail the longitudinal reinforcing steel with a maximum spacing of 8 inches center-to-center. For oversized drilled shafts, if analysis indicates potential hinging zone below ground, appropriate detailing shall be provided.
19.5.4	1	LRFD Articles 5.8.3, 5.13.3.6, and 5.13.3.8	LRFD Articles 5.7.3, 5.12.8.6, and 5.12.8.8
19.5.6.1	1	LRFD Article 10.6.3.1.5	SCDOT Geotechnical Design Manual

**List of changes to SCDOT Bridge Design Manual (continued)**

19.5.6.2	1	LRFD Article 10.6.3.2.5	SCDOT Geotechnical Design Manual
19.5.7	1	LRFD Article 10.6.3.3	SCDOT Geotechnical Design Manual
19.5.8	1	LRFD Articles 3.12.6, 10.6.2.2, and 10.7.2.3	LRFD Article 3.12.6, 10.6.2.4, and SCDOT Geotechnical Design Manual
19.5.9	1	LRFD Articles 5.10.8 and 5.13.3	LRFD Articles 5.10.6 and 5.12.8
19.5.9	12,20	LRFD Article 5.13.3	LRFD Article 5.12.8
19.5.9	18	LRFD Article 5.8.3.4	LRFD Article 5.7.3.4
Figure 19.5-2	note	LRFD Article 10.6.3.1.5	LRFD Article 10.6.1.3
20.1.8	1	LRFD Article 5.6.3	LRFD Article 5.8.2
20.3.4	8	LRFD Article 5.6.3	LRFD Article 5.8.2
20.3.5	10	LRFD Article 5.7.4.3	LRFD Article 5.6.4.3
20.3.7	1	LRFD Article 5.7.4	LRFD Article 5.6.4
20.3.7	4	LRFD Article 5.7.4.3	LRFD Article 5.6.4.3
20.3.7	6	LRFD Article 5.7.4.1	LRFD Article 5.6.4.1
21.1.1.2	2	$\Delta T = \alpha L (T_{MaxDesign} - T_{MinDesign})$ LRFD Equation 3.12.2.3-1	$\Delta T = 1.2\alpha L (T_{MaxDesign} - T_{MinDesign})$ modified LRFD Equation 3.12.2.3-1 Where, 1.2 is the load factor.
21.1.1.12			Delete Examples 21.1-1 and 21.1-2
21.2.1.3	3	$\Delta T = \alpha L (T_{MaxDesign} - T_{MinDesign})$ LRFD Equation 3.12.2.3-1	$\Delta T = 1.2\alpha L (T_{MaxDesign} - T_{MinDesign})$ modified LRFD Equation 3.12.2.3-1 Where, 1.2 is the load factor.
21.2.1.8	5, 6	For beveled bearing plates, maintain a minimum of 1 in thickness at the edge of the bearing plate.	For beveled bearing plates, use a minimum thickness of 1 ½ inches at the centerline of bearing while maintaining 1 inch minimum at the low side of the bevel.
21.2.3	21, 22	The designer shall check the bearing against horizontal walking in accordance with LRFD Article 14.7.6.4	The designer shall check the bearing against horizontal walking.
DM 0108	21	LRFD Article 5.14.1.4.9	LRFD Article 5.12.3.3.9
DM 0108	26-27	The requirements of AASHTO LRFD Articles 5.14.1.4.6, 5.14.1.4.7, and 5.14.1.4.8 shall apply.	The requirements of AASHTO LRFD Articles 5.12.3.3.6, 5.12.3.3.7, and 5.12.3.3.8 shall apply.
DM 0108	35,42	LRFD Article 5.9.4	LRFD Article 5.9.2.3



South Carolina  
Department of Transportation

## **BRIDGE DESIGN MEMORANDUM – DM0320**

**TO:** RPG Structural Design Engineers  
Structural Design Consultants

**DATE:** May 8, 2020

**RE:** Reinforcing Steel Development Lengths for Bars in Tension and Reinforcing Steel Splice Lengths for Bars in Tension - Revisions to Figures 15.3-4, 15.3-5, and 15.3-6 and Sections 15.3.1.6 and 15.3.1.7 of the SCDOT Bridge Design Manual

**Apply these updated requirements to all projects where design has not advanced beyond the preliminary design phase.**

Due to revisions of the *AASHTO LRFD Bridge Design Specifications (AASHTO)* concerning reinforcing steel development and splice lengths, *SCDOT Bridge Design Manual (Manual)* Figure 15.3-4 – Development Lengths for Straight Bars in Tension (4 ksi), and Figure 15.3-6 – Splice Lengths for Bars in Tension (4 ksi) shall be superseded by the Tables included in this Design Memorandum:

- Table 1: Straight Bar Development Length,  $\ell_d$  [in], for Horizontal Bars with  $> 12''$  Concrete Cast Below;  $f'_c = 4$  ksi.;  $f_y = 60$  ksi.
- Table 2: Straight Bar Development Length,  $\ell_d$  [in], for Horizontal Bars with  $\leq 12''$  Concrete Cast Below, or Other Bars;  $f'_c = 4$  ksi.;  $f_y = 60$  ksi.
- Table 3: Tension Lap Splice Length,  $\ell_{st}$  [in], for Horizontal Bars with  $> 12''$  Concrete Cast Below;  $f'_c = 4$  ksi.;  $f_y = 60$  ksi.
- Table 4: Tension Lap Splice Length,  $\ell_{st}$  [in], for Horizontal Bars with  $\leq 12''$  Concrete Cast Below, or Other Bars;  $f'_c = 4$  ksi.;  $f_y = 60$  ksi.

Notes:

Tables include modification factors for reinforcement location, normal weight concrete, and reinforcement confinement as specified in *AASHTO* Articles 5.10.8.2.1b and 5.10.8.2.1c.



May 8, 2020

The following tables are applicable to both uncoated bars and galvanized bars.

Reinforcement confinement factor is conservatively calculated by taking the transverse reinforcement index as 0.

Excess reinforcement factor is taken conservatively as 1.0.

Tension lap splice lengths are based on *AASHTO* Article 5.10.8.4.3.

Concrete clear cover is defined as the cover to the bar being considered.

Development Lengths of #14[43], and #18[57] bars are calculated using the equations from *AASHTO* 6th Edition Articles 5.11.2.1.1 – Tension Development Length, 5.11.2.1.2 – Modification Factors which Increase  $\ell_d$ , and 5.11.2.1.3 – Modification Factors which Decrease  $\ell_d$ .

For Development Lengths of #14[43], and #18[57] bars, a factor of 0.8 is applied where reinforcement being developed is spaced laterally not less than 6.0 in. center-to-center, with not less than 3.0 in. clear cover measured in the direction of the spacing.

Use Table 1 and Table 2 to determine development lengths of bars in tension unless the designer performs more refined calculations of development lengths as specified in *AASHTO* Article 5.10.8.2.1. For concrete clear cover or bar spacing that falls between the table values, the development length for the smaller concrete clear cover or bar spacing shall be used unless more refined calculations are performed using *AASHTO* Article 5.10.8.2.1.

Use Table 3 and Table 4 to determine lap splice lengths for bars in tension unless the designer performs more refined calculations of lap splices as specified in *AASHTO* Article 5.10.8.4.3a. For concrete clear cover or bar spacing that falls between the table values, the development length for the smaller concrete clear cover or bar spacing shall be used unless more refined calculations are performed using *AASHTO* Article 5.10.8.4.3a.

Use Class B splices unless the designer performs more refined calculations as specified in *AASHTO* Article 5.10.8.4.3a.

**Delete Figure 15.3-5 –Development Lengths For Hooked Bars In Tension (4 ksi) of the Manual and use the requirements of *AASHTO* Article 5.10.8.2.4.**



May 8, 2020

**Delete the LRFD Article referenced in Section 15.3.1.6.1 of the *Manual* and replace with the following:**

Reference: LRFD Article 5.10.8.2

**Delete the first paragraph of Section 15.3.1.6.1 of the *Manual* and replace with the following:**

The development of bars in tension involves calculating the basic development length,  $\ell_{db}$ , which is modified by factors to reflect bar spacing, cover, reinforcement location, type of aggregate, and the ratio of required area to provide the area of reinforcement to be developed.

**Delete the third paragraph of Section 15.3.1.6.1 of the *Manual* and use Tables 1 and 2 below.**

**Delete the LRFD Article referenced in Section 15.3.1.6.3 of the *Manual* and replace with the following:**

Reference: LRFD Article 5.10.8.2.4

**Delete the last sentence of the first paragraph in Section 15.3.1.6.3 of the *Manual*.**

**Delete the third paragraph of Section 15.3.1.6.3 of the *Manual* and replace with the following:**

Refer to LRFD Figure C5.10.8.2.4a-1 in the commentary for hooked-bar details for the development of standard hooks. Use the same figure for both uncoated and galvanized bars.

**Delete the LRFD Article referenced in Section 15.3.1.7 of the *Manual* and replace with the following:**

Reference: LRFD Article 5.10.8.4

**Delete the LRFD Article referenced in Section 15.3.1.7.2 of the *Manual* and replace with the following:**

Reference: LRFD Article 5.10.8.4.3

May 8, 2020

**Delete the first paragraph of Section 15.3.1.7.2 of the *Manual* and replace with the following:**

Many of the same factors that affect development length affect splice length. Consequently, tension lap splices are a function of the bar development length ( $\ell_d$ ). Tension lap splices are classified, based upon the ratio of provided steel to required steel and the percent of steel spliced, into two classes — Class A and Class B. Designers are encouraged to splice bars at points of minimum stress.

**Delete the third paragraph of Section 15.3.1.7.2 of the *Manual* and use Tables 3 and 4 below.**

**Delete the LRFD Articles referenced in Section 15.3.1.7.4 of the *Manual* and replace with the following:**

Reference: LRFD Article 5.10.8.4.2b, 5.10.8.4.3b and 5.10.8.4.5b

**Delete the LRFD Articles referenced in Section 15.3.1.7.6 of the *Manual* and replace with the following:**

Reference: LRFD Article 5.10.8.4.3b and 5.10.8.4.4



Table 1: Straight Bar Development Length, $\ell_d$ [in], for Horizontal Bars with > 12" Concrete Cast Below; $f'_c = 4$ ksi.; $f_y = 60$ ksi.												
Clear Cover	Bar Size US [M]	Reinforcement Spacing										
		4"	4 ½"	5"	5 ½"	6"	6 ½"	7"	7 ½"	8"	8 ½"	≥ 9"
1"	#3 [10]	15	15	15	15	15	15	15	15	15	15	15
	#4 [13]	19	19	19	19	19	19	19	19	19	19	19
	#5 [16]	28	28	28	28	28	28	28	28	28	28	28
	#6 [19]	39	39	39	39	39	39	39	39	39	39	39
	#7 [22]	50	50	50	50	50	50	50	50	50	50	50
	#8 [25]	63	63	63	63	63	63	63	63	63	63	63
	#9 [29]	77	77	77	77	77	77	77	77	77	77	77
	#10 [32]	93	93	93	93	93	93	93	93	93	93	93
	#11 [36]	110	110	110	110	110	110	110	110	110	110	110
	#14 [43]	N/A	114	114	114	114	114	114	114	114	114	114
#18 [57]	N/A	N/A	N/A	N/A	N/A	147	147	147	147	147	147	
1 ½"	#3 [10]	15	15	15	15	15	15	15	15	15	15	15
	#4 [13]	19	19	19	19	19	19	19	19	19	19	19
	#5 [16]	24	24	24	24	24	24	24	24	24	24	24
	#6 [19]	29	29	29	29	29	29	29	29	29	29	29
	#7 [22]	37	37	37	37	37	37	37	37	37	37	37
	#8 [25]	47	47	47	47	47	47	47	47	47	47	47
	#9 [29]	60	58	58	58	58	58	58	58	58	58	58
	#10 [32]	76	71	71	71	71	71	71	71	71	71	71
	#11 [36]	94	85	85	85	85	85	85	85	85	85	85
	#14 [43]	N/A	114	114	114	114	114	114	114	114	114	114
#18 [57]	N/A	N/A	N/A	N/A	N/A	147	147	147	147	147	147	
2"	#3 [10]	15	15	15	15	15	15	15	15	15	15	15
	#4 [13]	19	19	19	19	19	19	19	19	19	19	19
	#5 [16]	24	24	24	24	24	24	24	24	24	24	24
	#6 [19]	29	29	29	29	29	29	29	29	29	29	29
	#7 [22]	36	33	33	33	33	33	33	33	33	33	33
	#8 [25]	47	42	38	38	38	38	38	38	38	38	38
	#9 [29]	60	53	48	47	47	47	47	47	47	47	47
	#10 [32]	76	68	61	58	58	58	58	58	58	58	58
	#11 [36]	94	83	75	69	69	69	69	69	69	69	69
	#14 [43]	N/A	114	114	114	114	114	114	114	114	114	114
#18 [57]	N/A	N/A	N/A	N/A	N/A	147	147	147	147	147	147	
2 ½"	#3 [10]	15	15	15	15	15	15	15	15	15	15	15
	#4 [13]	19	19	19	19	19	19	19	19	19	19	19
	#5 [16]	24	24	24	24	24	24	24	24	24	24	24
	#6 [19]	29	29	29	29	29	29	29	29	29	29	29
	#7 [22]	36	33	33	33	33	33	33	33	33	33	33
	#8 [25]	47	42	38	38	38	38	38	38	38	38	38
	#9 [29]	60	53	48	44	43	43	43	43	43	43	43
	#10 [32]	76	68	61	55	51	49	49	49	49	49	49
	#11 [36]	94	83	75	68	63	59	59	59	59	59	59
	#14 [43]	N/A	114	114	114	114	114	114	114	114	114	114
#18 [57]	N/A	N/A	N/A	N/A	N/A	147	147	147	147	147	147	
≥ 3"	#3 [10]	15	15	15	15	15	15	15	15	15	15	15
	#4 [13]	19	19	19	19	19	19	19	19	19	19	19
	#5 [16]	24	24	24	24	24	24	24	24	24	24	24
	#6 [19]	29	29	29	29	29	29	29	29	29	29	29
	#7 [22]	36	33	33	33	33	33	33	33	33	33	33
	#8 [25]	47	42	38	38	38	38	38	38	38	38	38
	#9 [29]	60	53	48	44	43	43	43	43	43	43	43
	#10 [32]	76	68	61	55	51	48	48	48	48	48	48
	#11 [36]	94	83	75	68	63	58	54	53	53	53	53
	#14 [43]	N/A	114	114	114	114	92	92	92	92	92	92
#18 [57]	N/A	N/A	N/A	N/A	N/A	118	118	118	118	118	118	

Note: N/A refers to cases where the clear spacing between bars does not meet the minimum spacing requirements for cast-in-place concrete, LRFD 5.10.3.1, using a maximum aggregate size of 1.5".



Table 2: Straight Bar Development Length, $\ell_d$ [in], for Horizontal Bars with $\leq 12''$ Concrete Cast Below, or Other Bars; $f'_c = 4$ ksi.; $f_y = 60$ ksi.												
Clear Cover	Bar Size US [M]	Reinforcement Spacing										
		4"	4 ½"	5"	5 ½"	6"	6 ½"	7"	7 ½"	8"	8 ½"	≥ 9"
1"	#3 [10]	12	12	12	12	12	12	12	12	12	12	12
	#4 [13]	15	15	15	15	15	15	15	15	15	15	15
	#5 [16]	22	22	22	22	22	22	22	22	22	22	22
	#6 [19]	30	30	30	30	30	30	30	30	30	30	30
	#7 [22]	39	39	39	39	39	39	39	39	39	39	39
	#8 [25]	48	48	48	48	48	48	48	48	48	48	48
	#9 [29]	59	59	59	59	59	59	59	59	59	59	59
	#10 [32]	72	72	72	72	72	72	72	72	72	72	72
	#11 [36]	84	84	84	84	84	84	84	84	84	84	84
#14 [43]	N/A	81	81	81	81	81	81	81	81	81	81	
#18 [57]	N/A	N/A	N/A	N/A	105	105	105	105	105	105	105	
1 ½"	#3 [10]	12	12	12	12	12	12	12	12	12	12	12
	#4 [13]	15	15	15	15	15	15	15	15	15	15	15
	#5 [16]	18	18	18	18	18	18	18	18	18	18	18
	#6 [19]	22	22	22	22	22	22	22	22	22	22	22
	#7 [22]	29	29	29	29	29	29	29	29	29	29	29
	#8 [25]	36	36	36	36	36	36	36	36	36	36	36
	#9 [29]	46	45	45	45	45	45	45	45	45	45	45
	#10 [32]	59	55	55	55	55	55	55	55	55	55	55
	#11 [36]	72	65	65	65	65	65	65	65	65	65	65
#14 [43]	N/A	81	81	81	81	81	81	81	81	81	81	
#18 [57]	N/A	N/A	N/A	N/A	105	105	105	105	105	105	105	
2"	#3 [10]	12	12	12	12	12	12	12	12	12	12	12
	#4 [13]	15	15	15	15	15	15	15	15	15	15	15
	#5 [16]	18	18	18	18	18	18	18	18	18	18	18
	#6 [19]	22	22	22	22	22	22	22	22	22	22	22
	#7 [22]	28	26	26	26	26	26	26	26	26	26	26
	#8 [25]	36	32	29	29	29	29	29	29	29	29	29
	#9 [29]	46	41	37	36	36	36	36	36	36	36	36
	#10 [32]	59	52	47	45	45	45	45	45	45	45	45
	#11 [36]	72	64	58	53	53	53	53	53	53	53	53
#14 [43]	N/A	81	81	81	81	81	81	81	81	81	81	
#18 [57]	N/A	N/A	N/A	N/A	105	105	105	105	105	105	105	
2 ½"	#3 [10]	12	12	12	12	12	12	12	12	12	12	12
	#4 [13]	15	15	15	15	15	15	15	15	15	15	15
	#5 [16]	18	18	18	18	18	18	18	18	18	18	18
	#6 [19]	22	22	22	22	22	22	22	22	22	22	22
	#7 [22]	28	26	26	26	26	26	26	26	26	26	26
	#8 [25]	36	32	29	29	29	29	29	29	29	29	29
	#9 [29]	46	41	37	34	33	33	33	33	33	33	33
	#10 [32]	59	52	47	43	39	38	38	38	38	38	38
	#11 [36]	72	64	58	53	48	45	45	45	45	45	45
#14 [43]	N/A	81	81	81	81	81	81	81	81	81	81	
#18 [57]	N/A	N/A	N/A	N/A	105	105	105	105	105	105	105	
≥ 3"	#3 [10]	12	12	12	12	12	12	12	12	12	12	12
	#4 [13]	15	15	15	15	15	15	15	15	15	15	15
	#5 [16]	18	18	18	18	18	18	18	18	18	18	18
	#6 [19]	22	22	22	22	22	22	22	22	22	22	22
	#7 [22]	28	26	26	26	26	26	26	26	26	26	26
	#8 [25]	36	32	29	29	29	29	29	29	29	29	29
	#9 [29]	46	41	37	34	33	33	33	33	33	33	33
	#10 [32]	59	52	47	43	39	37	37	37	37	37	37
	#11 [36]	72	64	58	53	48	45	41	41	41	41	41
#14 [43]	N/A	81	81	81	65	65	65	65	65	65	65	
#18 [57]	N/A	N/A	N/A	N/A	84	84	84	84	84	84	84	

Note: N/A refers to cases where the clear spacing between bars does not meet the minimum spacing requirements for cast-in-place concrete, LRFD 5.10.3.1, using a maximum aggregate size of 1.5".



**Table 3: Tension Lap Splice Length,  $\ell_{st}$  [in] for Horizontal Bars with > 12" Concrete Cast Below;  $f'_c = 4$  ksi.;  $f_y = 60$  ksi.**

Clear Cover	Bar Size US [M]	Reinforcement Spacing																	
		4"		4 ½"		5"		5 ½"		6"		6 ½"		7"		7 ½"		≥ 8"	
		Class		Class		Class		Class		Class		Class		Class		Class		Class	
		A	B	A	B	A	B	A	B	A	B	A	B	A	B	A	B	A	B
1"	#3 [10]	15	19	15	19	15	19	15	19	15	19	15	19	15	19	15	19	15	19
	#4 [13]	19	25	19	25	19	25	19	25	19	25	19	25	19	25	19	25	19	25
	#5 [16]	28	37	28	37	28	37	28	37	28	37	28	37	28	37	28	37	28	37
	#6 [19]	39	50	39	50	39	50	39	50	39	50	39	50	39	50	39	50	39	50
	#7 [22]	50	65	50	65	50	65	50	65	50	65	50	65	50	65	50	65	50	65
	#8 [25]	N/A	N/A	63	82	63	82	63	82	63	82	63	82	63	82	63	82	63	82
	#9 [29]	N/A	N/A	N/A	N/A	77	99	77	99	77	99	77	99	77	99	77	99	77	99
	#10 [32]	N/A	N/A	N/A	N/A	93	121	93	121	93	121	93	121	93	121	93	121	93	121
#11 [36]	N/A	N/A	N/A	N/A	N/A	N/A	110	142	110	142	110	142	110	142	110	142	110	142	
1 ½"	#3 [10]	15	19	15	19	15	19	15	19	15	19	15	19	15	19	15	19	15	19
	#4 [13]	19	25	19	25	19	25	19	25	19	25	19	25	19	25	19	25	19	25
	#5 [16]	24	31	24	31	24	31	24	31	24	31	24	31	24	31	24	31	24	31
	#6 [19]	29	37	29	37	29	37	29	37	29	37	29	37	29	37	29	37	29	37
	#7 [22]	37	49	37	49	37	49	37	49	37	49	37	49	37	49	37	49	37	49
	#8 [25]	N/A	N/A	47	61	47	61	47	61	47	61	47	61	47	61	47	61	47	61
	#9 [29]	N/A	N/A	N/A	N/A	58	76	58	76	58	76	58	76	58	76	58	76	58	76
	#10 [32]	N/A	N/A	N/A	N/A	71	92	71	92	71	92	71	92	71	92	71	92	71	92
#11 [36]	N/A	N/A	N/A	N/A	N/A	N/A	85	110	85	110	85	110	85	110	85	110	85	110	
2"	#3 [10]	15	19	15	19	15	19	15	19	15	19	15	19	15	19	15	19	15	19
	#4 [13]	19	25	19	25	19	25	19	25	19	25	19	25	19	25	19	25	19	25
	#5 [16]	24	31	24	31	24	31	24	31	24	31	24	31	24	31	24	31	24	31
	#6 [19]	29	37	29	37	29	37	29	37	29	37	29	37	29	37	29	37	29	37
	#7 [22]	36	47	33	43	33	43	33	43	33	43	33	43	33	43	33	43	33	43
	#8 [25]	N/A	N/A	42	55	38	49	38	49	38	49	38	49	38	49	38	49	38	49
	#9 [29]	N/A	N/A	N/A	N/A	48	62	47	61	47	61	47	61	47	61	47	61	47	61
	#10 [32]	N/A	N/A	N/A	N/A	61	79	58	75	58	75	58	75	58	75	58	75	58	75
#11 [36]	N/A	N/A	N/A	N/A	N/A	N/A	69	90	69	90	69	90	69	90	69	90	69	90	
2 ½"	#3 [10]	15	19	15	19	15	19	15	19	15	19	15	19	15	19	15	19	15	19
	#4 [13]	19	25	19	25	19	25	19	25	19	25	19	25	19	25	19	25	19	25
	#5 [16]	24	31	24	31	24	31	24	31	24	31	24	31	24	31	24	31	24	31
	#6 [19]	29	37	29	37	29	37	29	37	29	37	29	37	29	37	29	37	29	37
	#7 [22]	36	47	33	43	33	43	33	43	33	43	33	43	33	43	33	43	33	43
	#8 [25]	N/A	N/A	42	55	38	49	38	49	38	49	38	49	38	49	38	49	38	49
	#9 [29]	N/A	N/A	N/A	N/A	48	62	44	57	43	55	43	55	43	55	43	55	43	55
	#10 [32]	N/A	N/A	N/A	N/A	61	79	55	72	51	66	49	63	49	63	49	63	49	63
#11 [36]	N/A	N/A	N/A	N/A	N/A	N/A	68	88	63	81	59	76	59	76	59	76	59	76	
≥ 3"	#3 [10]	15	19	15	19	15	19	15	19	15	19	15	19	15	19	15	19	15	19
	#4 [13]	19	25	19	25	19	25	19	25	19	25	19	25	19	25	19	25	19	25
	#5 [16]	24	31	24	31	24	31	24	31	24	31	24	31	24	31	24	31	24	31
	#6 [19]	29	37	29	37	29	37	29	37	29	37	29	37	29	37	29	37	29	37
	#7 [22]	36	47	33	43	33	43	33	43	33	43	33	43	33	43	33	43	33	43
	#8 [25]	N/A	N/A	42	55	38	49	38	49	38	49	38	49	38	49	38	49	38	49
	#9 [29]	N/A	N/A	N/A	N/A	48	62	44	57	43	55	43	55	43	55	43	55	43	55
	#10 [32]	N/A	N/A	N/A	N/A	61	79	55	72	51	66	48	62	48	62	48	62	48	62
#11 [36]	N/A	N/A	N/A	N/A	N/A	N/A	68	88	63	81	58	75	54	70	53	69	53	69	

Note: N/A refers to cases where the clear spacing between bars does not meet the minimum spacing requirements for cast-in-place concrete, LRFD 5.10.3.1, using a maximum aggregate size of 1.5".



Table 4: Tension Lap Splice Length, $\ell_s$ [in] for Horizontal Bars with $\leq 12''$ Concrete Cast Below, or Other Bars; $f'_c = 4$ ksi.; $f_y = 60$ ksi.																			
Clear Cover	Bar Size US [M]	Reinforcement Spacing																	
		4"		4 ½"		5"		5 ½"		6"		6 ½"		7"		7 ½"		≥ 8"	
		Class		Class		Class		Class		Class		Class		Class		Class		Class	
		A	B	A	B	A	B	A	B	A	B	A	B	A	B	A	B	A	B
1"	#3 [10]	12	15	12	15	12	15	12	15	12	15	12	15	12	15	12	15	12	15
	#4 [13]	15	19	15	19	15	19	15	19	15	19	15	19	15	19	15	19	15	19
	#5 [16]	22	28	22	28	22	28	22	28	22	28	22	28	22	28	22	28	22	28
	#6 [19]	30	39	30	39	30	39	30	39	30	39	30	39	30	39	30	39	30	39
	#7 [22]	39	50	39	50	39	50	39	50	39	50	39	50	39	50	39	50	39	50
	#8 [25]	N/A	N/A	48	63	48	63	48	63	48	63	48	63	48	63	48	63	48	63
	#9 [29]	N/A	N/A	N/A	N/A	59	77	59	77	59	77	59	77	59	77	59	77	59	77
	#10 [32]	N/A	N/A	N/A	N/A	72	93	72	93	72	93	72	93	72	93	72	93	72	93
#11 [36]	N/A	N/A	N/A	N/A	N/A	N/A	84	110	84	110	84	110	84	110	84	110	84	110	
1 ½"	#3 [10]	12	15	12	15	12	15	12	15	12	15	12	15	12	15	12	15	12	15
	#4 [13]	15	19	15	19	15	19	15	19	15	19	15	19	15	19	15	19	15	19
	#5 [16]	18	24	18	24	18	24	18	24	18	24	18	24	18	24	18	24	18	24
	#6 [19]	22	29	22	29	22	29	22	29	22	29	22	29	22	29	22	29	22	29
	#7 [22]	29	37	29	37	29	37	29	37	29	37	29	37	29	37	29	37	29	37
	#8 [25]	N/A	N/A	36	47	36	47	36	47	36	47	36	47	36	47	36	47	36	47
	#9 [29]	N/A	N/A	N/A	N/A	45	58	45	58	45	58	45	58	45	58	45	58	45	58
	#10 [32]	N/A	N/A	N/A	N/A	55	71	55	71	55	71	55	71	55	71	55	71	55	71
#11 [36]	N/A	N/A	N/A	N/A	N/A	N/A	65	85	65	85	65	85	65	85	65	85	65	85	
2"	#3 [10]	12	15	12	15	12	15	12	15	12	15	12	15	12	15	12	15	12	15
	#4 [13]	15	19	15	19	15	19	15	19	15	19	15	19	15	19	15	19	15	19
	#5 [16]	18	24	18	24	18	24	18	24	18	24	18	24	18	24	18	24	18	24
	#6 [19]	22	29	22	29	22	29	22	29	22	29	22	29	22	29	22	29	22	29
	#7 [22]	28	36	26	33	26	33	26	33	26	33	26	33	26	33	26	33	26	33
	#8 [25]	N/A	N/A	32	42	29	38	29	38	29	38	29	38	29	38	29	38	29	38
	#9 [29]	N/A	N/A	N/A	N/A	37	48	36	47	36	47	36	47	36	47	36	47	36	47
	#10 [32]	N/A	N/A	N/A	N/A	47	61	45	58	45	58	45	58	45	58	45	58	45	58
#11 [36]	N/A	N/A	N/A	N/A	N/A	N/A	53	69	53	69	53	69	53	69	53	69	53	69	
2 ½"	#3 [10]	12	15	12	15	12	15	12	15	12	15	12	15	12	15	12	15	12	15
	#4 [13]	15	19	15	19	15	19	15	19	15	19	15	19	15	19	15	19	15	19
	#5 [16]	18	24	18	24	18	24	18	24	18	24	18	24	18	24	18	24	18	24
	#6 [19]	22	29	22	29	22	29	22	29	22	29	22	29	22	29	22	29	22	29
	#7 [22]	28	36	26	33	26	33	26	33	26	33	26	33	26	33	26	33	26	33
	#8 [25]	N/A	N/A	32	42	29	38	29	38	29	38	29	38	29	38	29	38	29	38
	#9 [29]	N/A	N/A	N/A	N/A	37	48	34	44	33	43	33	43	33	43	33	43	33	43
	#10 [32]	N/A	N/A	N/A	N/A	47	61	43	55	39	51	38	49	38	49	38	49	38	49
#11 [36]	N/A	N/A	N/A	N/A	N/A	N/A	53	68	48	63	45	59	45	59	45	59	45	59	
≥ 3"	#3 [10]	12	15	12	15	12	15	12	15	12	15	12	15	12	15	12	15	12	15
	#4 [13]	15	19	15	19	15	19	15	19	15	19	15	19	15	19	15	19	15	19
	#5 [16]	18	24	18	24	18	24	18	24	18	24	18	24	18	24	18	24	18	24
	#6 [19]	22	29	22	29	22	29	22	29	22	29	22	29	22	29	22	29	22	29
	#7 [22]	28	36	26	33	26	33	26	33	26	33	26	33	26	33	26	33	26	33
	#8 [25]	N/A	N/A	32	42	29	38	29	38	29	38	29	38	29	38	29	38	29	38
	#9 [29]	N/A	N/A	N/A	N/A	37	48	34	44	33	43	33	43	33	43	33	43	33	43
	#10 [32]	N/A	N/A	N/A	N/A	47	61	43	55	39	51	37	48	37	48	37	48	37	48
#11 [36]	N/A	N/A	N/A	N/A	N/A	N/A	53	68	48	63	45	58	41	54	41	53	41	53	

Note: N/A refers to cases where the clear spacing between bars does not meet the minimum spacing requirements for cast-in-place concrete, LRFD 5.10.3.1, using a maximum aggregate size of 1.5".



May 8, 2020

**Please note these revisions in your copy of the *SCDOT Bridge Design Manual*.**

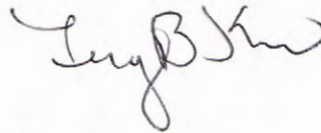

Terry B. Koon, P.E.  
Structural Design Support Engineer

TBK:hl

ec:

John Boylston, Director of Preconstruction  
Robbie Isgett, Director of Construction  
David Cook, Director of Maintenance  
Robert Perry, Director of Traffic Engineering  
Chris Gaskins, Design Build Engineer  
Rob Bedenbaugh, Precon. Support Engineer  
David Rister, Acting Director of Mega Projects

Jennifer Necker, RP Engineer - Lowcountry  
Leah Quattlebaum, RP Engineer – Pee Dee  
Philip Sandel, RP Engineer - Midlands  
Julie Barker, RP Engineer – Upstate  
Tad Kitowicz, FHWA  
Blake Gerken, FHWA

File: PC/TBK/HL



## **BRIDGE DESIGN MEMORANDUM – DM0420**

**TO:** RPG Structural Design Engineers  
RPG Roadway Design Engineers  
Structural Design Consultants  
Roadway Design Consultants

**DATE:** July 31, 2020

**RE:** Providing Asset IDs for Bridges and Roadway Structures

**Apply these updated requirements to all projects where plans have not progressed beyond final submittal with signed and sealed drawings.**

The requirements for providing Asset IDs specified in the fourth paragraph of Bridge Design Memorandum DM0214 are amended as follows:

For plans of replacement bridges and new bridges that are not replacing existing bridges, include the new Asset ID on the bridge plans title sheet in the space provided. Request new Asset IDs according to Section 4.4 of the *SCDOT Load Rating Guidance Document*. Once the *Asset ID Request Form* has been returned to the Asset ID requestor with the new Asset ID included, submit a copy of the form to the Structural Design Support Quality Assurance Engineer.

For plans prepared for widening, rehabilitation, or other modifications of existing bridges where a new separate bridge is not being proposed, include the Asset ID of the existing bridge on the bridge plans title sheet in the space provided.

For multiple bridges included in the same set of plans, include all Asset IDs on the bridge plans title sheet in the space provided. Provide notation to identify which Asset ID represents which bridge.

Refer to SCDOT Drawings and Details No. 700-01 and 700-02 for location of Asset IDs on the bridge plans title sheet.

For new culverts and multiple pipes meeting the definition of “Bridge” as specified in Section 1.3.1 of the *SCDOT Load Rating Guidance Document*, include the new Asset ID in the structural drawings for each applicable structure. When structural drawings are not required in the roadway plans (i.e. locations of multiple pipes), place the new Asset ID on the roadway plan and profile





sheet where the structure is shown. Request a new Asset ID for each applicable structure described above according to the requirements of Section 4.4 of the *SCDOT Load Rating Guidance Document*. Once the *Asset ID Request Form* has been returned to the Asset ID requestor with the new Asset ID included, submit a copy of the form to the Structural Design Support Quality Assurance Engineer. Display the Asset ID in the plans as shown in Figure 1.0 below.

For extensions and/or widenings of existing culverts and multiple pipes meeting the definition of "Bridge" as specified in Section 1.3.1 of the *SCDOT Load Rating Guidance Document*, include the existing Asset ID in the structural drawings for each applicable structure. When structural drawings are not required in the roadway plans (i.e. locations of multiple pipes), place the existing Asset ID on the roadway plan and profile sheet where the structure is shown. Display the Asset ID in the plans as shown in Figure 1.0 below.



Figure 1.0, Asset ID Box

**Please note the changes below in your copy of the *SCDOT Bridge Design Manual*.**

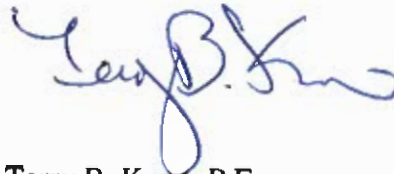

Terry B. Koon, P.E.  
Structural Design Support Engineer

TBK:hl

ec:

John Boylston, Director of Preconstruction  
Robbie Isgett, Director of Construction  
David Cook, Director of Maintenance  
Robert Perry, Director of Traffic Engineering  
Chris Gaskins, Design Build Engineer  
Rob Bedenbaugh, Precon. Support Engineer  
David Rister, Acting Dir. Of Mega Projects

Jennifer Necker, RP Engineer - Lowcountry  
Leah Quattlebaum, RP Engineer - Pee Dee  
Philip Sandel, RP Engineer - Midlands  
Julie Barker, RP Engineer - Upstate  
Tad Kitowicz, FHWA  
Blake Gerken, FHWA

File: PC/TBK/HL



**BRIDGE DESIGN MEMORANDUM – DM0520**

**TO:** RPG Structural Design Engineers  
Structural Design Consultants

**DATE:** October 6, 2020

**RE:** Neglecting the Effect of Elastic Gains in the Design of Prestressed Concrete Girders

**Apply these updated requirements to all projects where plans have not progressed beyond final submittal with signed and sealed drawings.**

Add the following paragraph to the end of Section 15.5.3.4 of the *Bridge Design Manual*.

When designing prestressed concrete girders, do not count the effects of elastic gains when calculating prestress losses.

**Please note the changes below in your copy of the SCDOT Bridge Design Manual.**



Terry B. Koon, P.E.  
Structural Design Support Engineer

TBK:hl

cc:

John Boylston, Director of Preconstruction  
Robbie Isgett, Director of Construction  
David Cook, Director of Maintenance  
Robert Perry, Director of Traffic Engineering  
Chris Gaskins, Design Build Engineer  
Rob Bedenbaugh, Precon. Support Engineer  
David Rister, Acting Dir. Of Mega Projects

Jennifer Necker, RP Engineer - Lowcountry  
Leah Quattlebaum, RP Engineer – Pee Dee  
Philip Sandel, RP Engineer - Midlands  
Julie Barker, RP Engineer – Upstate  
Tad Kitowicz, FHWA  
Blake Gerken, FHWA

File: PC/TBK/HL



## **BRIDGE DESIGN MEMORANDUM – DM0122**

**To:** RPG Structural Engineers  
Design Consultants

**Date:** April 25, 2022

**RE:** Seismic Design Summary Reports for New Bridges

**Apply these updated requirements to all projects where design has not advanced beyond the preliminary design phase.**

Preliminary and final seismic design summary reports shall be provided for all new bridges with Seismic Design Categories (SDC) of B, C, and D. The exceptions to this are the following:

- single span bridges, which do not require detailed seismic analysis
- bridge plans developed under the *Supplemental Design Criteria for Low Volume Bridge Replacement Projects*

### **PRELIMINARY SEISMIC DESIGN SUMMARY REPORT**

The structural design engineer shall submit along with the preliminary bridge plans and preliminary bridge geotechnical engineering report a preliminary seismic design summary report for the bridge documenting the design strategy that will be used to meet the required seismic performance criteria and the analysis approach to capture and verify the intended design strategy. The preliminary report shall be signed by the structural engineer. The report shall describe the seismic design strategy and analysis approach for the bridge and shall include, at a minimum, the following information:

- A project description (including Project ID, county, route, crossing, longitude and latitude); the geological and hydrological features of the site; preliminary bridge configuration including construction staging or temporary widening; layout showing superstructure, bearing types, span types and lengths, end bent types, interior bent types, skew angle; diaphragms; shear keys; superstructure to substructure connections; expansion joints; wing walls; abutment types; shear walls, etc.



- Any special issues (including construction, geotechnical, hydrological, right-of-way, environmental, etc.) that have driven the selection of the structure configuration
- Any unique structural issues that will affect the seismic design
- Any geotechnical issues that may affect the design of the bridge including:
  - Any indication of whether soil shear strength loss (SSL) is anticipated
  - Any indication of whether there is the potential for slope instability
  - Any indication of whether structural or geotechnical mitigation will be utilized
- The seismic design specifications or manuals used for the design (including document edition and applicable Bridge Design Memoranda)
- The design earthquake(s), the Acceleration Design Response Spectra (ADRS) data (with complete design response spectrum curve data and curves attached),
- the Operational Classification (OC)
- the Seismic Design Category (SDC)
- The performance objectives of the bridge per specifications in regard the expected service performance and damage levels
- Ductility criteria to be achieved
- Intended design strategy to achieve the performance objectives, such as what elements are capacity protected, how ductile elements are going to be detailed to achieve the intended behavior, how structural elements and connections are configured to satisfy balanced stiffness distribution and load transfer path.
- The analysis approaches to capture and verify the bridge's seismic behavior that the performance objectives have been achieved, including all applicable seismic models to be analyzed and how structural elements (including soils in contact) are going to be modeled.
- The name(s) of computer software that will be used for modeling structure and soil

### **FINAL SEISMIC DESIGN SUMMARY REPORT**

The structural design engineer shall submit along with the 95% bridge plans and final bridge geotechnical engineering report a final seismic design summary report for the bridge documenting the design strategies that have been used to meet the required seismic performance criteria for the bridge and the analysis approaches that have been used to capture the bridge seismic behavior and verify the design strategies. The final report shall be signed and sealed by the structural design engineer, who shall be a registered professional engineer in the state of South Carolina. The report shall describe the seismic design strategies and analysis approaches for the bridge and shall include, at a minimum, the following information:

- A project description (including information required in the preliminary seismic summary report and any changes since preliminary design submittal)
- The seismic design specifications and or manuals used for the design (including document edition and applicable Bridge Design Memoranda)



- The design earthquake(s), the ADRS data (with complete design response spectrum curve data and curves attached)
- The Operational Classification (OC)
- The Seismic Design Category (SDC)
- The objectives of service performance and damage levels
- Ductility criteria achieved
- Seismic design strategy to achieve the required seismic performance including allowed damages and capacity protected elements, stiffness balances between bents, fused versus non-fused superstructure to substructure connections, potential plastic hinge locations, any unique aspects of the project that have driven the structural configuration and seismic modeling performed
- Brief discussion of how geotechnical and or hydrological hazards, such as SSL and scour, have been considered in the modeling process.
- Seismic analysis/design software used in the project (for structure and soils)
- Brief discussion of methodologies to model nonlinear properties in both Multimodal Spectral Analysis (MSA) and pushover analysis (if applicable) including backwall pressure, wing wall pressure, soils, plastic hinges, joints, expansion bearings, shear walls (if applicable),
- Mass participation ratio achieved
- Fundamental periods, discussion of short period check, soil column-structure-earthquake resonance check
- Easy to read tabulated and graphed results from the design earthquake analysis including Safety Evaluation Earthquake (SEE) and Functional Evaluation Earthquake (FEE) cases (if applicable); tension and compression models (if applicable); pushover models; analysis of bridge with and without SSL (including scour scenarios, if applicable, referring to AASHTO LRFD Bridge Design Specifications for recommended scour depth for seismic analysis); a brief discussion of the modeling results; and engineering justification for choices of design and detailing, including the following at a minimum:
  - Global displacement demand vs. global yield displacement and displacement capacity
  - Global ductility demand vs. specified limits
  - Local ductility capacity vs. specified limit
  - Seismic detailing, including design of cap support length for superstructure, hinge region detailing, shear keys, retaining blocks, anchor bolts, bearings, wing walls, abutments, shear walls, pile-cap joints, column-cap joints, pile-footing joints, column-footing joints, etc.
  - Discussion of approved design variances and justifications (with design variance approval attached),
  - Brief discussion of seismic hazard mitigation (if applicable)

To provide additional guidance for creating consistent formatting of the reports, please see the report outlines attached below.



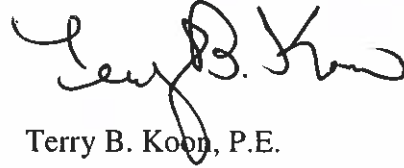

Terry B. Koon, P.E.  
Structural Design Support Engineer

TBK:hl

ec:

John Boylston, Director of Preconstruction  
Robbie Isgett, Director of Construction  
David Cook, Director of Maintenance  
Robert Perry, Director of Traffic Engineering  
Chris Gaskins, Director of Alternative Delivery  
Rob Bedenbaugh, Director of Engineering Support

Jennifer Necker, RP Engineer - Lowcountry  
Leah Quattlebaum, RP Engineer – Pee Dee  
Adam Humphries, RP Engineer - Midlands  
Julie Barker, RP Engineer – Upstate  
Jae Mattox, Alternative Delivery Engineer  
Tad Kitowicz, FHWA  
Blake Gerken, FHWA

File: PC/TBK/HL



## (Preliminary or Final) Seismic Summary Report

---

*County*  
*Project ID*  
*Route and Local Road Name*  
*Replace Bridge or Construct Bridge*  
*Crossing Description*

Prepared for  
SCDOT  
955 Park Street  
Columbia SC 29201

Consultant ABC (or SCDOT RPG)  
Consultant ABC Address (if applicable)

Date of report  
SCDOT logo if in-house report



## Outline of the Preliminary Seismic Summary Report

### **1. Project Description**

- 1.1 Basic Project Information
- 1.2 Unique Structural, Geotechnical and Other Issues, if Applicable

### **2. Seismic Design Criteria and Objectives**

- 2.1 Seismic Design Specifications
- 2.2 Operational Classification
- 2.3 Design Earthquakes
- 2.4 Seismic Design Category
- 2.5 Expected Seismic Performance and Damage Levels
- 2.6 Ductility Criteria

### **3. Seismic Design Strategy and Analysis Approach**

- 3.1 Seismic Design Strategy
- 3.2 Seismic Analysis Approach
- 3.3 Seismic Design Software





## Outline of the Final Seismic Summary Report

### **1. Project Description**

- 1.1 Basic Project Information
- 1.2 Unique Structural, Geotechnical and Other Issues, if Applicable

### **2. Seismic Design Criteria and Objectives**

- 2.1 Seismic Design Specifications
- 2.2 Operational Classification
- 2.3 Design Earthquakes
- 2.4 Seismic Design Category
- 2.5 Expected Seismic Performance and Damage Levels
- 2.6 Ductility Criteria

### **3. Seismic Design Strategy and Analysis Approach**

- 3.1 Seismic Design Strategy
- 3.2 Demand Analysis Approach
- 3.3 Capacity Analysis Approach
- 3.4 Seismic Design Software

### **4. Seismic Modeling Results and Analysis**

- 4.1 Mass participation Ratio Achieved and Fundamental Periods
- 4.2 Global Displacement Demand vs. Global Displacement Capacity
- 4.3 Global Ductility Demand vs. Specified Global Ductility Demand Limits
- 4.4 Local Ductility Capacity vs. Specified Limit

### **5. Approved Design Variances, if Applicable**

### **6. Seismic Detailing**

### **7. Seismic Hazard Mitigation, if Applicable**





South Carolina  
Department of Transportation

## **BRIDGE DESIGN MEMORANDUM – DM0222**

**TO:** RPG Structural Engineers  
Design Consultants

**Date:** June 16, 2022

**RE:** Revisions to Requirements for Providing *Top of Slab Elevations Sheet* in Bridge Plans

**Apply these updated requirements to all projects where design has not advanced beyond the preliminary design phase.**

In order to partner with the SCDOT Construction Division, District Construction personnel, and Carolinas Association of General Contractors (CAGC) to provide quality structures plans with information useful to the construction process, it has been determined that adding Top of Slab Elevation Sheets to all sets of bridge plans with cast-in-place bridge decks would be helpful in setting up screeds and to better ensure proper placement of concrete.

Therefore for all bridges with cast-in-place reinforced concrete bridge decks, Top of Slab Elevation Sheets shall be included in the bridge plans starting at the 95% Bridge Plans Submittal. The following changes will be made in the Bridge Design Manual to incorporate the new requirement.

Revise the first sentence of Section **6.3.14.10 Top of Slab Elevations Sheet** of Bridge Design Manual as follows:

The Top of Slab Elevations Sheet shall be provided for all bridges with cast-in-place concrete decks.

Add the following additional item to the bulleted list of **Section 6.3.14.10 Top of Slab Elevations Sheet** of Bridge Design Manual:

- Any cross-slope break points in addition to finished grade

**Please note the changes above in your copy of the *SCDOT Bridge Design Manual*.**

Terry B. Koon, P.E.  
Structural Design Support Engineer

TBK:hl



www.scdot.org  
An Equal Opportunity  
Affirmative Action Employer  
855-GO-SCDOT (855-467-2368)

ec:

John Boylston, Director of Preconstruction  
Robbie Isgett, Director of Construction  
David Cook, Director of Maintenance  
Robert Perry, Director of Traffic Engineering  
Chris Gaskins, Director of Alternative Delivery  
Rob Bedenbaugh, Director of Engineering Support

Jennifer Necker, RP Engineer - Lowcountry  
Leah Quattlebaum, RP Engineer – Pee Dee  
Adam Humphries, RP Engineer - Midlands  
Julie Barker, RP Engineer – Upstate  
Jae Mattox, Preconstruction Alternative Delivery Engineer  
Tad Kitowicz, FHWA  
Blake Gerken, FHWA

File: PC/TBK/HL

