

SCDOT TRAFFIC SIGNALS

MATERIAL SPECIFICATIONS

Revised
11/1/2021

MATERIAL SPECIFICATION REVISIONS

NOTE: SCDOT has made note of revisions since the last set of specifications, however, it is the responsibility of the contractor/vendor to read the specifications and verify materials meet requirements. Do not rely solely on this revision sheet for specification changes.

Date	Specification	Description	Details of Revision
11/1/2021	M688.7	CONTROLLER AND CABINET ASSEMBLY	Revised CPU Module requirement added 2070 1C
11/1/2021	M688.3	VIDEO DETECTION	Expanded spec.
5/12/2021	M688.4	RADAR DETECTION SYSTEM	New Spec.
2/5/2020	M686.4	PEDESTRIAN PUSH BUTTON STATION ASSEMBLY WITH SIGN	Updated 1.2.5- PUSH BUTTON FOR GREEN LIGHT to R10-4a on page 1 and picture on page 2
7/18/2019	M686.4	PEDESTRIAN PUSH BUTTON STATION ASSEMBLY WITH SIGN	Revised push button type requirement. Updated pay items.
4/25/2019	M689.1	BATTERY BACK-UP SYSTEM	New Spec.
1/15/2017	M677.1	ELECTRICAL CABLE	Cable and jacket diameter tolerances added. Jacket description expanded.
5/16/2016	M688.7	CONTROLLER AND CABINET ASSEMBLY	Various revisions
5/16/2016	M686.4	PEDESTRIAN PUSH BUTTON STATION ASSEMBLY WITH SIGN	Revised dual mount bracket requirement
3/1/2016	M686.1		Revised requirements for removable door
3/1/2016	M688.7		Replaced with 4/15/2013 spec until revision is complete – QPL items match this spec
3/1/2016	M677.4		Removed Furnish Fiber Interconnect Center specification
3/1/2016	M677.3		Revised Fiber Optic Cable specifications to be Industry Standards
2/1/2016	M688.6		Various minor revisions
2/1/2016	M688.5		Various minor revisions
9/14/2015	M688.3		Clarified processing unit type and added Network Services Policy
7/1/2015	M688.7		Revised required conflict monitor and accommodates operation of 18 phase
7/1/2015	M688.6		Various revisions
7/1/2015	M688.5		Revised hole requirements
6/23/2015	M682.4		Added information about powder coating
12/15/2014	M686.3		Removed pay item information. See supplemental specifications.
12/15/2014	M686.1		Removed pay item information. See supplemental specifications.
7/31/2014	M686.1		Revised hanger and signal head specifications
6/11/2014	M686.1		Revised to include Non-Pixelated LED specification, revised backplate specifications
5/19/2014	M677.1		Updated specifications
12/2/2013	M686.2		Added Non-Pixelated LED specification

7/22/2013	M686.3		Revised module lens requirements
6/1/2013	M686.3		Revised modules types, to comply with latest ITE specification, revised terminal strip material, fade resistant for 5 years, identifiers on equipment and packaging, warranty
4/15/2013	M682.4		Revised Class 3000 Concrete
4/15/2013	M688.5		Revised Class 5000 Concrete
4/15/2013	M688.6		Revised Class 3000 Concrete
4/15/2013	M688.7		Revised Class 3000 Concrete
3/6/2013	M686.4		New State Contract, Added Pay Items

Traffic Signals
Material Specifications
11/01/21

Table of Contents

SPEC	TITLE	Revision Date
M677.1	FURNISH ELECTRICAL CABLE	1/15/2017
M677.3	INDUSTRY STANDARDS FOR FIBER OPTIC CABLE	3/1/2016
M677.6	FURNISH FACTORY TERMINATED PATCH PANEL	10/1/2012
M678.1	FURNISH WIRE, SEALANT, AND/OR MATERIALS FOR DETECTOR LOOP	10/1/2012
M680.2	FURNISH SPLICE BOX/JUNCTION BOX	10/1/2012
M682.3	FURNISH STEEL CABLE	10/1/2012
M682.4	FURNISH PEDESTRIAN POLE AND BASE	4/15/2013
M686.1	FURNISH VEHICLE SIGNAL HEADS AND BACKPLATES	3/1/2016
M686.3	FURNISH PEDESTRIAN SIGNAL HEADS	12/15/2014
M686.4	FURNISH PEDESTRIAN PUSH BUTTON STATION ASSEMBLY WITH SIGN	2/05/2020
M686.5	FURNISH SYMBOLIC LED BLANKOUT SIGN	10/1/2012
M688.3	FURNISH VIDEO DETECTION SYSTEM	11/1/2021
M688.4	FURNISH RADAR DETECTION SYSTEM	5/12/2021
M688.5	FURNISH STEEL STRAIN POLE AND FOUNDATION	2/1/2016
M688.6	FURNISH CONCRETE STRAIN POLE	2/1/2016
M688.7	FURNISH CONTROLLER AND CABINET ASSEMBLY	11/01/21
M688.9	FURNISH SOLAR POWERED FLASHER ASSEMBLY	10/1/2012
M689.1	BATTERY BACK-UP ASSEMBLY	04/25/2019

M677.1 ELECTRICAL CABLE

1.1 Description

This specification describes requirements for furnishing traffic signal, loop lead-in, pedestrian signal, and pedestrian push button Electrical Cable.

1.2 Materials

1.2.1 Black Cable

1.2.1.1 Traffic Signal Head Black 8 Conductor Wiring

BLACK - Unless specified elsewhere, the traffic signal cable shall be (8 conductor). The conductor shall be #14 AWG, 19 strands, bare copper. The conductor insulation shall be high density polyethylene and shall be both ultraviolet and weather resistant. The wall thickness for the single conductor shall be 0.025" minimum point thickness with a .124" nominal diameter. The Cabling overall lay shall be 6" with a left hand lay. 1 (60) Non-Hydroscopic Polypropylene filler material shall be utilized to produce a circular cross section. The conductor cable assembly shall be wrapped with a 0.001 inch clear Mylar tape material applied helically with a minimum 25% overlap. The overall cable assembly shall be provided with a black high density polyethylene jacket which is both ultraviolet and weather resistant. Jacket shall be rigid, non-collapsing and does not shrink when cut in a cross-section. The wall thickness shall be 0.042 inch minimum point thickness. The cable shall have a nominal cabling diameter of .393" (+/- 5%) and a nominal jacket diameter of .487" (+/- 5%) and shall have a ripcord for easy jacket removal. The outer cable jacket shall have sequential foot marks. Traffic signal cable shall be manufactured in accordance with the requirements of Underwriters' Laboratories, SCDOT, IMSA 20-1, ROHS, Federal specifications, and the National Electric Code.

The traffic signal cable must also meet or exceed specifications in the chart below.

Conductor Insulation

Conductor Colors	Insulation Color	External Jacket Size, AWG
White, Yellow Red, Green White w/Black Band, Yellow w/Black Band Red w/Black Band, Green w/Black Band	Black	#14

1.2.1.2 Pedestrian Signal Head Black 4 conductor Wiring

BLACK - Unless specified elsewhere, the traffic signal cable shall be (4 conductor). The conductor shall be #14 AWG, 19 strands, bare copper. The conductor insulation shall be high density polyethylene and shall be both ultraviolet and weather resistant. The wall thickness for the single conductor shall be 0.025" minimum point thickness with a .124" nominal diameter. The Cabling overall lay shall be 4.50" left hand lay. 4 (60) Non-Hydroscopic Polypropylene filler material shall be utilized to produce a circular cross section. The conductor cable assembly shall be wrapped with a 0.001 inch clear Mylar tape material applied helically with a minimum 25% overlap. The overall cable assembly shall be provided with a black high density polyethylene jacket which is both ultraviolet and weather resistant. Jacket shall be rigid, non-collapsing and does not shrink when cut in a cross-section. The wall thickness shall be 0.045 inch minimum point thickness. The cable shall have a nominal cabling diameter of .296" (+/- 5%) and a nominal jacket diameter of .373" (+/- 5%) and shall have a ripcord for easy jacket removal.

The outer cable jacket shall have sequential foot marks. Traffic signal cable shall be manufactured in accordance with the requirements of Underwriters' Laboratories, SCDOT, IMSA 20-1, ROHS, Federal specifications, and the National Electric Code.

The traffic signal cable must also meet or exceed specifications in the chart below

Conductor Insulation

Conductor Colors	External Jacket	
	Insulation Color	Size, AWG
White, Yellow, Red, Green	Black	#14

1.2.1.3 Traffic Signal Head Black 12 Conductor Wiring

BLACK - Unless specified elsewhere, the traffic signal cable shall be (12 conductor). The conductor shall be #14 AWG, 19 strands, bare copper. The conductor insulation shall be high density polyethylene and shall be both ultraviolet and weather resistant. The wall thickness for the single conductor shall be 0.025" minimum point thickness with a .124" nominal diameter. The Cabling overall lay shall be 6 3/4" with a left hand lay. The conductor cable assembly shall be wrapped with a 0.001 inch clear Mylar tape material applied helically with a minimum 25% overlap. The overall cable assembly shall be provided with a black high density polyethylene jacket which is both ultraviolet and weather resistant. Jacket shall be rigid, non-collapsing and does not shrink when cut in a cross-section. The wall thickness shall be 0.060 inch minimum point thickness. The cable shall have a nominal cabling diameter of .487" (+/- 5%) and a nominal jacket diameter of .607" (+/- 5%) and shall have a ripcord for easy jacket removal. The outer cable jacket shall have sequential foot marks. Traffic signal cable shall be manufactured in accordance with the requirements of Underwriters' Laboratories, SCDOT, IMSA 20-1, ROHS, Federal specifications, and the National Electric Code.

The traffic signal cable must also meet or exceed specifications in the chart below.

Conductor Insulation

Conductor Colors	External Jacket	
	Insulation Color	Size, AWG
White, Yellow Red, Green White w/Black Band, Yellow w/Black Band Red w/Black Band, Green w/Black Band White w/Blue Band, Yellow w/Blue Band Red w/Blue Band, Green w/Blue Band	Black	#14

1.2.2 Gray Cable

1.2.2.1 Loop lead-in Gray 4 Pair Wiring

GRAY - Unless specified elsewhere, the loop lead-in cable shall be four individually shielded pairs (8 conductor). Each pair shall be individually twisted (two turns per foot minimum). The conductor shall be #14 AWG, 19 strands, bare copper. The conductor insulation shall be high density polyethylene and shall be both ultraviolet and weather resistant. The nominal insulation thickness shall be 0.025". The nominal insulation diameter shall be .124". Each pair shall be wrapped with a 0.001 inch aluminum mylar

foiled shield with a minimum 25% overlap. Aluminum is to be located on the outside. 4 (60) non-hydroscopic polypropylene filler material shall be utilized to produce a circular cross section. The cabling overall lay shall be a 5.50" left hand lay. The drain wire shall be #16 AWG, 19 strands, tinned copper. The conductor cable assembly shall be wrapped with a 0.001 inch clear Mylar binder applied helically with a minimum 25% overlap. The overall cable assembly shall be provided with a high density polyethylene jacket which is both ultraviolet and weather resistant. Jacket shall be rigid, non-collapsing and does not shrink when cut in a cross-section. Nominal Jacket diameter shall be 0.525" (+/- 5%) and shall have a ripcord for easy jacket removal. Nominal Cabling Diameter shall be .445" (+/- 5%). The nominal jacket thickness shall be 0.042". The outer cable jacket shall have sequential foot marks. Traffic signal cable shall be manufactured in accordance with the requirements of SCDOT, IMSA 50-2, ROHS, and the National Electric Code.

The twisted pair loop lead-in cable must also meet or exceed specifications in the chart below.

Conductor Insulation

<i>Pair Color</i>	<i>Insulation Color</i>	<i>External Jacket Size, AWG</i>
White-Yellow Red-Green White w/Black Band-Yellow w/Black Band Red w/Black Band-Green w/Black Band	Gray	#14

1.2.2.2 Pedestrian Push Button Gray 2 Pair Wiring

GRAY - Unless specified elsewhere, the loop lead-in cable shall be two individually shielded pairs (4 conductor). Each pair shall be individually twisted (two turns per foot minimum). The conductor shall be #14 AWG, 19 strands, bare copper. The conductor insulation shall be high density polyethylene and shall be both ultraviolet and weather resistant. The nominal insulation thickness shall be 0.025". The nominal insulation diameter shall be .124". Each pair shall be wrapped with a 0.001 inch aluminum mylar foiled shield with a minimum 25% overlap. Aluminum is to be located on the outside. 3 (60) non-hydroscopic polypropylene filler material shall be utilized to produce a circular cross section. The cabling overall lay shall be a 4.00" left hand lay. The drain wire shall be #16 AWG, 19 strands, tinned copper. The conductor cable assembly shall be wrapped with a 0.001 inch clear Mylar binder applied helically with a minimum 25% overlap. The overall cable assembly shall be provided with a high density polyethylene jacket which is both ultraviolet and weather resistant. Jacket shall be rigid, non-collapsing and does not shrink when cut in a cross-section. Nominal Jacket diameter shall be 0.40" (+/- 5%) and shall have a ripcord for easy jacket removal. Nominal Cabling Diameter shall be .335" (+/- 5%). The nominal jacket thickness shall be 0.035". The outer cable jacket shall have sequential foot marks. Traffic signal cable shall be manufactured in accordance with the requirements of SCDOT, IMSA 50-2, ROHS, and the National Electric Code.

The twisted pair loop lead-in cable must also meet or exceed specifications in the chart below.

Conductor Insulation

<i>Pair Color</i>	<i>Insulation Color</i>	<i>External Jacket Size, AWG</i>
White-Yellow Red-Green	Gray	#14

1.2.2.3 Loop lead-in Gray 8 Pair Wiring

GRAY - Unless specified elsewhere, the loop lead-in cable shall be eight individually shielded pairs (16 conductor). Each pair shall be individually twisted (two turns per foot minimum). The conductor shall be #14 AWG, 19 strands, bare copper. The conductor insulation shall be high density polyethylene and shall be both ultraviolet and weather resistant. Jacket shall be rigid, non-collapsing and does not

shrink when cut in a cross-section. The nominal insulation thickness shall be 0.025". The nominal insulation diameter shall be .134". Each pair shall be wrapped with a 0.001 inch aluminum mylar foiled shield with a minimum 25% overlap. Aluminum is to be located on the outside. 4 (60) non-hydroscopic polypropylene filler material shall be utilized to produce a circular cross section. The cabling overall lay shall be a 11" left hand lay. The drain wire shall be #16 AWG, 19 strands, tinned copper. The conductor cable assembly shall be wrapped with a 0.001 inch clear Mylar binder applied helically with a minimum 25% overlap. The overall cable assembly shall be provided with a high density polyethylene jacket which is both ultraviolet and weather resistant. Nominal Jacket diameter shall be 0.930" (+/- 5%) and shall have a ripcord for easy jacket removal. Nominal Cabling Diameter shall be .770" (+/- 5%). The nominal jacket thickness shall be 0.080". The outer cable jacket shall have sequential foot marks. Traffic signal cable shall be manufactured in accordance with the requirements of SCDOT, IMSA 50-2, ROHS, and the National Electric Code.

The twisted pair loop lead-in cable must also meet or exceed specifications in the chart below.

Conductor Insulation

<i>Pair Color</i>	<i>Insulation Color</i>	<i>External Jacket Size, AWG</i>
White-Yellow Red-Green White w/Black Band-Yellow w/Black Band Red w/Black Band-Green w/Black Band White w/Blue Band-Yellow w/Blue Band Red w/Blue Band-Green w/Blue Band White w/Orange Band-Yellow w/Orange Band Red w/Orange Band-Green w/Orange Band	Gray	#14

1.2.3 Certification

CATALOG CUTS ARE REQUIRED

1.2.4 Warranty

The Vendor shall furnish SCDOT with any warranties on equipment and materials that are provided by the Manufacturer or Vendor as normal trade practice.

1.2.5 Labeling and Delivery

Unless otherwise stated, the cable shall be supplied in minimum reels of 1,000 feet, for splice-free installation.

The Manufacturer shall be required to mark each cable and cable reel to facilitate easy identification of the various sizes when stored in stockpiles.

1.3 Measurement

Electrical Cable, of the size and numbers of conductors specified, shall be measured by LINEAR FEET and furnished in 1000' reels.

1.4 Payment

Furnishing Electrical Cable, measured as provided above, will be paid at the contract unit price bid for:

FURNISH NO. 14 COPPER WIRE, 4 CONDUCTOR - BLACK	1000' REEL
FURNISH NO. 14 COPPER WIRE, 2 PAIR CONDUCTOR - GRAY	1000' REEL
FURNISH NO. 14 COPPER WIRE, 8 CONDUCTOR - BLACK	1000' REEL
FURNISH NO. 14 COPPER WIRE, 4 PAIR CONDUCTOR - GRAY	1000' REEL
FURNISH NO. 14 COPPER WIRE, 12 CONDUCTOR - BLACK	1000' REEL
FURNISH NO. 14 COPPER WIRE, 8 PAIR CONDUCTOR - GRAY	1000' REEL

677.3 FIBER OPTIC CABLE

1.1.1 Industry Standard

- The optical fiber **cable plant** consists of optical fiber cables, connectors, mounting panels, jumper cables, and other passive components, but it does not include active components.
- TIA-526-7 (OFSTP-7)-2002+A1:2008, *Measurement of Optical Power Loss of Installed Single-Mode Fiber Cable Plant*. This standard specifies singlemode optical loss measurement methods between two passively connected points using an optical source and power meter. An Optical Loss Test Set uses a light source to inject light in the fiber and a measurement device to measure the light out- this measures the attenuation (optical loss).
- Singlemode fiber (OS1, OS2) shall not have more than 0.5 dB attenuation (signal loss) per kilometer. That is measured with an Optical Loss Test Set.
- No more than 20% light loss will be accepted. Singlemode fiber (OS1, OS2, OSP) shall not have more than 0.5 dB attenuation (signal loss) per kilometer. That is measured with an Optical Loss Test Set.
- An OTDR is a good tool to “see” the overall “health” of the installed fiber OR to locate breaks, estimate connector and splice loss, identify macrobends (bends visible to the eye but hidden in the cable jacket) and microbends (a microbend could be caused if the fiber coating squeezes a fiber as it contracts at very low temperatures, ran over by a vehicle, or if it is stressed during installation). Both bends can result in increased attenuation that can degrade system performance and minimize optical throughput. Fusion or mechanical splices shall not have a loss of more than 0.3 dB. Mechanical splices are not SCDOT standard splice methodology. SCDOT allows Singlemode connector mating (patch cord to fiber interconnect center coupler) a max loss of 0.75 dB when planning and testing. The same loss is allowed from the patch cord to the Ethernet switch. Essentially signal loss of 0.75 dB is expected and allowed each time two factory connectors are mated. FYI- factory terminated patch cords have an average loss of 0.3 dB for factory-polished singlemode pigtails suitable for splicing.
- This standard includes an encircled flux launch condition metric (i.e. launch cable which allows the OTDR to settle down and analyze the true reflections of the installed cable, splices, and connectors) for measuring cable plant. Additionally, this standard includes the description of using an optical time domain reflectometer (OTDR) for total attenuation measurement and measurements of individual component loss.
- Outside Plant Cable OSP installation- The standard calls for water-blocked cables (cables suitable for outside plant use) with a minimum pulling tension of 600 pounds.
- Minimum bend radius is 20 times the cable diameter under max rated pulling tension and 10 times unloaded (unloaded means slack storing and permanently installed).
- ANSI/TIA/EIA-598-C-2005, *Optical Fiber Cable Color Coding*. This standard specifies the recommended identification for individual fibers, fiber units, and groups of fiber units
- within a cable structure (jacket).

1.1.2 Cable

- The cable shall meet all requirements stated in RUS-90 as well as those stated within this document. The cable shall be an accepted product of the United States Department of Agriculture Rural Utility Service as meeting the requirements of RUS-PE-90. The cable shall be new, unused, and of current design and manufacture.
- The single-mode fiber used in the cable shall conform to the following specifications:

Typical Core Diameter:	8.3 μm
Cladding Diameter:	125.0 + 1.0 μm by fiber end measurement
Core-to-Cladding Offset:	< 1.0 μm
Cladding Non-Circularity:	< 2.0% (Defined as: [1-(min. cladding dia. max. cladding dia.)] x 100)
Coating Diameter:	250 + 15 μm
Attenuation Uniformity:	No point discontinuity greater than 0.1 dB at either 1300 nm or 1550 μm .
- The change in attenuation at extreme operational temperatures for single-mode fibers shall not be greater than 0.40 dB/km at 1550 nm and 0.5 at 1310 nm, with 80% of the measured values no greater than 0.10 dB/km at 1550 nm.
- The maximum dispersion shall + 3.3 ps/(nm • km) for 1285 nm through 1330 and shall be < 18 ps/(nm • km) at 1550 nm.

1.1.3 Fiber Characteristics

- All fibers in the cable shall be usable fibers and meet required industry standards.
- All optical fibers shall be sufficiently free of surface imperfections and inclusions to meet the optical, mechanical, and environmental requirements to this specification.

- Each optical fiber shall consist of a doped silica core surrounded by a concentric silica cladding.
- The coating shall be a dual-layered, UV cured acrylate applied by the fiber manufacturer. The coating shall be capable of being mechanically or chemically striped without damaging the fiber.

1.1.4 Cable Size and Configuration

- The core or buffer tubes containing the fibers and the interstices between the buffer tubes, fillers, and strength members in the core structure are filled with a suitable material to exclude water. Fibers may be assembled in either loose tube fiber bundles or tight buffered configurations. Both construction types must pass all the requirements of current industry standards such as ICEA S-87-640, Telcordia GR-20-CORE and RUS PE-90.
- Each loose tube configuration shall contain twelve (12) fibers. The fibers shall not adhere to the inside of the buffer tube.
- Each fiber and loose tube buffer shall be distinguishable from each other by means of color coding according to ANSI/TIA/EIA-598-C-2005, *Optical Fiber Cable Color Coding* as referenced below. Tight buffered fibers shall adhere to the same color coding standards.

1. Blue
2. Orange
3. Green
4. Brown
5. Slate
6. White
7. Red
8. Black
9. Yellow
10. Violet
11. Rose
12. Aqua

- Optical cable designs not specifically addressed by this section may be allowed if accepted by SCDOT. Justification for acceptance of a modified design must be provided to substantiate product utility and long term stability and endurance.

M677.6 FACTORY TERMINATED PATCH PANEL

1.1 Description

This specification describes requirements for furnishing a Factory Terminated Patch Panel. Included in this item is the splicing of the fiber optic cable; installing interconnection sleeves, jumpers, connectors and other hardware that may be needed for connecting the fiber optic cable to the signal system electronic devices.

1.2 Materials

1.2.1 *Factory Terminated Patch Panel*

The interconnect center shall be a factory terminated patch panel, including strain relief hardware and have termination/connection capacity for 12 fibers and a 200' tail.

1.2.2 *Certification*

CATALOG CUTS ARE REQUIRED

1.2.3 *Warranty*

The Vendor shall furnish SCDOT with any warranties on equipment and materials that are provided by the Manufacturer or Vendor as normal trade practice.

1.3 Measurement

Furnishing a Factory Terminated Patch Panel will be measured by EACH.

1.4 Payment

The Factory Terminated Patch Panel, as measured above, will be paid for at the contract unit price bid for:

FURNISH FACTORY TERMINATED PATCH PANEL	EA
--	----

M678.1 FURNISH WIRE, SEALANT, AND/OR MATERIALS FOR DETECTOR LOOP

1.1 Description

This specification describes requirements for furnishing Wire, Sealant, and/or Materials for a Detector Loop.

1.2 Materials

1.2.1 Loop Wire

Loop wire shall be splice-free lengths of: No. 14 AWG, 19 Strands, single-conductor bare copper wire. The conductor insulation (BLACK or GRAY) shall be high density polyethylene and shall be both ultraviolet and weather resistant. The wall thickness shall be 0.030 inch minimum point thickness. Cable shall be manufacturer in accordance with the requirements of Underwriters Laboratories, Federal specifications, and the National Electric Code.

1.2.2 Sealant

The loop sealant used to fill the saw cuts and other gaps, shall be of a type intended for traffic loop embedding. The cured sealant shall be semi-flexible, and be capable of adhering securely to concrete, asphalt, wood, metal, etc. It shall be unaffected by freeze-thaw cycling, salts, gasoline, oil, sewerage and corrosive chemicals. It shall be proportioned and mixed per the manufacturer's specifications. Acceptable sealants are listed on the SCDOT QPL.

1.2.3 Waterproofing Splice Materials

The splice at the "junction point" shall be made waterproof using the materials listed below:

- a) Cable Splice Kit - Commercially available, Low-Voltage, water-proof Splice-kit; to be Plymouth "PLYFLEX"; or 3M "SCOTCH-LOK", Unipak #3570, Resin 400, (or approved equal). To be installed per manufacturer's instructions.
- b) Heat Shrink tubes
- c) Gel Caps
- d) Vinyl plastic electrical tape (use where required)-Cold and weather resistant, 19 mm (3/4 inch) wide, 1.8 mm (7 mil) thickness, (Scotch 33+ or approved equal). Shall use liquid electrical coating (where required) - Fast-drying sealant compatible with vinyl tape, brush-applied (3M, Scotchkote or approved equal).

1.2.4 Underwater Splicing Kit

Where shown on the Plans, in very wet areas an Underwater Splice Kit may be required at the "junction point". This splicing kit shall consist of a two-piece mold-body, with pourable resin sealing compound, funnels, and end sealing strips (3M, Scotchcast 82-A1 or approved equal).

1.2.5 Wire Crimps

The PREFERRED splicing method at the "junction point", shall use a commercial/industrial grade, copper-alloy CRIMP-ON, with one end closed, of a size proper for the gauge of wires to be spliced, and

the number of conductors. It shall be installed with butt splice using a T & B type crimping tool or similar tool, intended for the purpose (NOT regular pliers). (Note: wire-nuts are not acceptable.)

1.2.6 Solder

The alternate method of splicing at the "junction point" is to use SOLDER, which shall be electronic-grade, rosin-core, 60 lead/40 tin. Acid-core solder is not acceptable, nor are acid-type soldering pastes.

1.2.7 Certification

The Vendor shall provide details for the loop sealant, loop wire, and lead-in wire proposed.

CATALOG CUTS ARE REQUIRED

SAMPLE REQUIRED

1.2.8 Warranty

The Vendor shall furnish SCDOT with any warranties on equipment and materials that are provided by the Manufacturer or Vendor as normal trade practice.

1.3 Measurement

Wire for Detector Loops, of the size and numbers of conductors specified, shall be measured by LINEAR FEET and furnished in 5000' reels.

1.4 Payment

Furnishing Wire for Detector Loops, measured as provided above, will be paid at the contract unit price bid for:

FURNISH NO. 14 COPPER WIRE, 1-CONDUCTOR FOR LOOP WIRE	5000' REEL
---	------------

M678.1 FURNISH WIRE, SEALANT, AND/OR MATERIALS FOR DETECTOR LOOP**1.1 Description**

This specification describes requirements for furnishing Wire, Sealant, and/or Materials for a Detector Loop.

1.2 Materials**1.2.1 Loop Wire**

Loop wire shall be splice-free lengths of: No. 14 AWG, 19 Strands, single-conductor bare copper wire. The conductor insulation (BLACK or GRAY) shall be high density polyethylene and shall be both ultraviolet and weather resistant. The wall thickness shall be 0.030 inch minimum point thickness. Cable shall be manufacturer in accordance with the requirements of Underwriters Laboratories, Federal specifications, and the National Electric Code.

1.2.2 Sealant

The loop sealant used to fill the saw cuts and other gaps, shall be of a type intended for traffic loop embedding. The cured sealant shall be semi-flexible, and be capable of adhering securely to concrete, asphalt, wood, metal, etc. It shall be unaffected by freeze-thaw cycling, salts, gasoline, oil, sewerage and corrosive chemicals. It shall be proportioned and mixed per the manufacturer's specifications. Acceptable sealants are listed on the SCDOT QPL.

1.2.3 Waterproofing Splice Materials

The splice at the "junction point" shall be made waterproof using the materials listed below:

- a) Cable Splice Kit - Commercially available, Low-Voltage, water-proof Splice-kit; to be Plymouth "PLYFLEX"; or 3M "SCOTCH-LOK", Unipak #3570, Resin 400, (or approved equal). To be installed per manufacturer's instructions.
- b) Heat Shrink tubes
- c) Gel Caps
- d) Vinyl plastic electrical tape (use where required)-Cold and weather resistant, 19 mm (3/4 inch) wide, 1.8 mm (7 mil) thickness, (Scotch 33+ or approved equal). Shall use liquid electrical coating (where required) - Fast-drying sealant compatible with vinyl tape, brush-applied (3M, Scotchkote or approved equal).

1.2.4 Underwater Splicing Kit

Where shown on the Plans, in very wet areas an Underwater Splice Kit may be required at the "junction point". This splicing kit shall consist of a two-piece mold-body, with pourable resin sealing compound, funnels, and end sealing strips (3M, Scotchcast 82-A1 or approved equal).

1.2.5 Wire Crimps

The PREFERRED splicing method at the "junction point", shall use a commercial/industrial grade, copper-alloy CRIMP-ON, with one end closed, of a size proper for the gauge of wires to be spliced, and

the number of conductors. It shall be installed with butt splice using a T & B type crimping tool or similar tool, intended for the purpose (NOT regular pliers). (Note: wire-nuts are not acceptable.)

1.2.6 Solder

The alternate method of splicing at the "junction point" is to use SOLDER, which shall be electronic-grade, rosin-core, 60 lead/40 tin. Acid-core solder is not acceptable, nor are acid-type soldering pastes.

1.2.7 Certification

The Vendor shall provide details for the loop sealant, loop wire, and lead-in wire proposed.

CATALOG CUTS ARE REQUIRED

SAMPLE REQUIRED

1.2.8 Warranty

The Vendor shall furnish SCDOT with any warranties on equipment and materials that are provided by the Manufacturer or Vendor as normal trade practice.

1.3 Measurement

Wire for Detector Loops, of the size and numbers of conductors specified, shall be measured by LINEAR FEET and furnished in 5000' reels.

1.4 Payment

Furnishing Wire for Detector Loops, measured as provided above, will be paid at the contract unit price bid for:

FURNISH NO. 14 COPPER WIRE, 1-CONDUCTOR FOR LOOP WIRE	5000' REEL
---	------------

M680.2 SPLICE BOX / JUNCTION BOX

1.1 Description

This specification describes requirements for furnishing a Splice Box and/or Junction Box. The Splice Box shall consist of a Box and Cover, installed over aggregate. The Splice Box is intended for use as a signal cable electrical enclosure. The Junction Box is intended for use as a loop detector "junction point".

1.2 Materials

1.2.1 Box and Cover

The Splice Box shall consist of a Base having an open top (the Box), with a separate removable Cover. They shall be made from a lightweight, blended modern material, using fiberglass reinforcement, and shall be NON-CONCRETE / NON-STEEL. They shall be GRAY IN COLOR. Covers shall have the LEGEND "TRAFFIC SIGNAL". They shall use HEX-HEAD stainless steel bolts. The PHYSICAL FEATURES AND THE NOMINAL SIZE AND DIMENSIONS for the Box and Cover, are shown on the Standards or the Design Details, and are listed below.

	<u>WIDTH</u>	<u>LENGTH</u>	<u>DEPTH</u>
SPLICE BOX:	13 inch	24 inch	18 inch
HAND BOX:	17 inch	30 inch	24 inch
MINI SPLICE BOX:	12 inch	12 inch	12 inch

1.2.2 Design Load

Boxes shall be designed to meet or exceed the loading requirements for a Tier 15 application per the Society of Cable Engineers (SCTE) ANSI/SCTE 77-2007 "Specification for Underground Enclosure Integrity, Table – Test Loads".

Thus, boxes shall be designed and tested for the following test loads: Cover- vertical load 22,500 pounds distributed over a 10 inch x 10 inch area. Box - vertical load 22,500 pounds distributed over a 5 inch x 10 inch. Box- lateral load of 1200 pounds per square foot . The cover deflection shall be less than 0.5 inch; and the box deflection less than 0.25 in/ft of length.

1.2.3 Western Underground Committee (WUC)

Using the above specified loads, the Splice Box shall meet or exceed the WUC "Recommended Guide No. 3.6, Non-Concrete Enclosures". Structural Requirements shall include: testing for Vertical Load on Cover; Vertical Load on Box; Lateral Load on Box. Further they shall meet WUC recommendations for: Accelerated Service per ASTM D-756; Chemical Resistance per ASTM D-543; Simulated Sunlight Resistance per ASTM G-53; plus Water Absorption; and Flammability. Covers shall be skid-resistant, with a minimum coefficient of friction of 0.50.

1.2.4 Certification

CATALOG CUTS ARE REQUIRED

1.2.5 Warranty

The Vendor shall furnish SCDOT with any warranties on equipment and materials that are provided by the Manufacturer or Vendor as normal trade practice.

1.3 Measurement

Furnishing a Splice Box will be measured by EACH Box including Box and Cover.

Furnishing a Junction Box will be measured incidental to the conduit to which it is used with.

1.4 Payment

Furnishing Splice Box and/or Junction Box, accepted and measured as provided above, will be paid for at the contract unit price bid for:

FURNISH 13"X24"X18"D.ELEC.FLUSH UNDGRD.ENCLOSURE-(STR.POLY.CONC.)HD	EA
FURNISH 17"X30"X24"D.ELEC.FLUSH UNDGRD.ENCLOSURE-(STR.POLY.CONC.)HD	EA
FURNISH 12"X12"X12"D.ELEC.FLUSH UNDGRD.ENCLOSURE-(STR.POLY.CONC.)HD	EA

M682.3 STEEL CABLE

1.1 Description

This specification describes requirements for furnishing splice-free lengths of Steel Cable with cable supports, for mounting signal heads, signs, interconnect runs, and installing back guys.

1.2 Materials

1.2.1 Fabrication

Steel Cable shall be fabricated of 7 steel wires, Class A double galvanized in accordance with ASTM A-475, and twisted into a single concentric strand to conform with the following schedule:

Diameter (inches)	Strand Size (AWG)	Tensile Strength (pounds)
1/4	14	3,150
3/8	11	6,950
7/16	9.5	9,350
1/2	8	12,000

Usage

Span Wire - All Steel Cable used as span wire shall be 3/8 inch in diameter, unless otherwise noted on the Plans.

Messenger Wire - All Steel Cable used as messenger shall be 1/4 inch in diameter, unless otherwise noted on the Plans.

Tether Wire - All Steel Cable used as tether wire shall be 1/4 inch in diameter, unless otherwise noted on the Plans.

Back Guy - All Steel Cable used for back guying shall be 3/8 inch in diameter, unless noted otherwise on the Plans.

Cable Supports

Aluminum Tie-wrap - Shall be Flat Aluminum Armor Tape, 0.05 inch Thick X 0.30 inch Wide, typically furnished in 10 pound coils.

Where specifically required, Support Rings (also called "cable rings", "messenger rings") shall be galvanized in accordance with ASTM A-153, and the design approved by the ENGINEER, and shall be 2 to 3 inches in diameter (to contain the Electrical Cables), and sized to specifically match the Steel Cable.

Miscellaneous Hardware

All hardware and fittings shall be of the type shown on the Standards or the Construction and Installations Details.

All hardware and fittings shall be made of galvanized steel or non-corrosive metal. The tensile strength of all hardware shall be equal-to or greater-than the Steel Cable installed.

All thimble-eye and oval eye-bolts used to connect the automatic compression dead-end clamps to wooden poles, shall be 3/4 inch diameter. S-hooks shall be the same diameter as the cable. Fiberglass insulators shall be fabricated from epoxy-resin impregnated fiberglass strands, and have a tensile strength 50% greater than the Steel Cable.

Certification

The Vendor shall provide a Certification from the Manufacturer that the Steel Cable has been tested to meet or exceed the required tensile strength.

Warranty

The Vendor shall furnish SCDOT with any warranties on equipment and materials that are provided by the Manufacturer or Vendor as normal trade practice.

1.3 Measurement

Steel Cable of the SIZE specified shall be measured by the LINEAR FEET and furnished in 1000' reels.

1.4 Payment

Accepted quantities of Steel Cable, measured as stated above will be paid for at the contract unit price bid for:

FURNISH 3/8" GALVANIZED STEEL CABLE	1000' REEL
FURNISH 1/4" GALVANIZED STEEL CABLE	1000' REEL

M682.4 PEDESTRIAN POLE AND BASE

1.1 Description

This specification describes requirements for furnishing a Pedestrian Pedestal Pole and Base.

1.2 Materials

1.2.1 Aluminum Base

Pedestrian bases shall be constructed of aluminum. The neck of the base shall be threaded to accommodate a 4 inch diameter aluminum pole. The neck will also house a set screw that prevents counter rotation.

1.2.2 Anchor Bolts

Four (4) Anchor Bolts shall be supplied with each base. Each Anchor Bolt shall be threaded at the top, and shall have an L-bend at the bottom. A total of eight nuts and eight flat washers shall be supplied. Nuts shall be ASTM 563 Grade A.

1.2.3 Aluminum Pole

Aluminum pedestrian pole shall be 4 inches in diameter and 4 feet, 8 feet and/or 10 feet in length. It shall be constructed of polished aluminum and threaded on one end.

1.2.4 Concrete

The Concrete provided shall be CLASS 3000, and shall be mixed, poured, and finished in accordance with SC DOT STANDARD SPECIFICATIONS, Section 701, 702, 703, and 704.

1.2.5 Powdercoating

Color to be specified in special provisions or on signal plan. Powdercoating over aluminum shall be done at the factory or during the manufacturing process.

1.2.6 Warranty

The Vendor shall furnish SCDOT with any warranties on equipment and materials that are provided by the Manufacturer or Vendor as normal trade practice.

1.3 Measurement

Furnishing a Pedestrian Pedestal Pole and Base will be measured by EACH including all required incidental hardware.

1.4 Payment

Furnishing a Pedestrian Pole and Base measured as provided above, will be paid for at the contract unit price for:

	FURNISH 4' BREAK-AWAY ALUMINUM PEDESTAL POLE AND BASE	EA
	FURNISH 8' BREAK-AWAY ALUMINUM PEDESTAL POLE AND BASE	EA
	FURNISH 10' BREAK-AWAY ALUMINUM PEDESTAL POLE AND BASE	EA

M686.1 VEHICLE SIGNAL HEADS AND BACKPLATES

1.1 Materials

1.1.1 Signal Heads

All Signal Heads shall conform to the ITE July 2005 "VTCSH". Specifications of the ITE (Light Emitting Diode (LED) Vehicular Traffic Signal Modules (hereafter referred to as ITE July 2005 "VTCSH".) published by the INSTITUTE OF TRANSPORTATION ENGINEERS (ITE), "Standard for Adjustable Face Vehicular Traffic Control Signal Heads" (latest Revision). All sections of each head shall be furnished by the SAME MANUFACTURER. The only exception is where the top section must be aluminum. Polycarbonate Vehicle Signal Heads of the size, type, and arrangement specified, are to be furnished by the Manufacturer or Vendor, together with ALL the necessary hardware for make-up and mounting. The basic material requirements are listed below:

1.1.1.1 Housing

The COLOR shall be Federal YELLOW (13538).

Each Signal Head housing shall consist of an assembly of separate interchangeable sections, each holding an individual optical unit, and stainless steel parts between the signal heads. THE TOP SECTION OF EACH 3-SECTION HEAD SHALL HAVE AN ALUMINUM REINFORCING / BEARING PLATE INSIDE AS WELL AS ON THE OUTSIDE OF THE HEAD. The Aluminum reinforcing / bearing plate SHALL HAVE TWO STAINLESS ¼" retaining BOLTS WITH LOCK WASHER AND NUT AND shall provide for a watertight seal to prevent water from entering the housing. THE BOLTS SHALL PROTRUDE COMPLETELY THRU BOTH PLATES AND THE TOP OF THE HEAD. The TOP SECTION OF THE FIVE-SECTION CLUSTER, AND OF THE FOUR-SECTION IN-LINE, SHALL BE POWDER COATED ALUMINUM. The Aluminum section shall be Federal Yellow (13538) and shall be fade resistant for a minimum of five years. The rest of those configurations shall be POLYCARBONATE and it shall also be fade resistant for five years. Heads with noticeable premature Fading shall be subject for replacement covered under the warranty.

The material of the Housing, Door, and Visor shall be engineering-grade structural, ultraviolet-stabilized PURE POLYCARBONATE resin. Other plastics are NOT acceptable. All edges shall be milled to a uniform round edge and free of all sharp edges.

1.1.1.2 Polycarbonate

The Department is aware of the design characteristics of this material--particularly the fact that as fillers are added for strength, the material becomes more brittle. We also recognize that signal manufacturers have optimized their designs around a specific formulation. Therefore the VENDOR shall provide complete particulars about the polycarbonate type number proposed for the Signal head. Further the VENDOR shall submit strength and wind tunnel test results (See Paragraph 1.2.5 Certification)

1.1.1.3 Door

The COLOR shall be Federal YELLOW (13538).

The door latches shall consist of stainless steel latch eye-bolts, wing-nut, and washer; all retained to keep them from falling to the street.

The hinges shall be reinforced protrusions (mortise and tenon) from the door. The hinges shall be attached to the head with Stainless steel roll pins or reinforced polycarbonate pins that are made as part of the head.

1.1.1.4 Visor

The Visor COLOR shall be Federal YELLOW (13538) outside, and dull BLACK (37038) inside.

The Visor CLASSIFICATION shall be TUNNEL (slot at bottom), unless otherwise specified.

The Visor shall be twist-on, attached to the housing with four stainless steel SCREWS, through the twist-on tabs on the visor.

1.1.1.5 Wiring

Wiring and Electrical shall be in accordance with ITE Standards. Color Coded wiring shall be factory connected to a barrier type TERMINAL BLOCK in the LOWER PORTION OF THE RED SECTION of each Signal Head. In the five-section cluster, the TERMINAL BLOCK shall be located in the (TOP) SECTION.

The TERMINAL BLOCK shall be double sided barrier type with two screws per barrier section; and shall make connections to the lamp wires using fast-on SPRING-LOADED SPADE LUGS and screws, (i.e. provisions should be made so that spade lugs or screws can be used on the same terminal block.) ONE PER SCREW. More than one neutral is allowed per terminal. The neutral designated terminal shall have triple stack connections supplied. The number of barrier sections in the TERMINAL BLOCK for the three and four section head, shall be 6-position, 12-terminal. For the five section head, it shall be 8-position, 16-terminal. The screws in the terminal block shall be no less than 8mm in length.

1.1.1.6 Mounting Assemblies

All mounting hardware shall be furnished.

Span Wire Mounting

Hardware for Span-Wire shall be finished Powder Coated Federal YELLOW (13538)

For Span-Wire mounting, the HANGER shall be cast ALUMINUM, and shall contain two stainless steel J-Hooks with stainless steel pin, properly sized BOWTIE cotter pin, lock washers and nuts, and have seven notches to position the hanging signal. A double weatherhead entrance shall be used. The weatherhead entrance BUSHING shall have a 1 1/2 inch hole for wire entry. THE NIPPLE USED SHALL BE OF THE SAME BRAND AS THE GOOSENECK AND SHALL HAVE AT LEAST TWO INCHES OF THREAD. THE THREAD PATTERN SHALL BE VIBRATION RESISTANT SEMI COURSE THREAD. THE NIPPLE SHALL BE TORQUED TO PROPER MANUFACTURER SPECIFICATIONS. THE SET SCREW SHALL BE INSTALLED WITH BLUE LOCTITE AND TIGHTNED SO THAT NIPPLE WILL NOT TURN. THE NIPPLE SHALL ALSO HOLD THE INTERNAL BEARING PLATE IN PLACE. The entrance diameter shall be maintained throughout the weatherhead, without restriction or reducing the hole diameter, into the signal head. No Tri-Stud hangers allowed. No special tools shall be required to tighten or adjust signal heads. Hangers with mismatched threads that will not tighten will be rejected. Span wire hangers shall not require disassembly to install on span wire.

For Span-Wire mounting, for MULTI-WAY heads, there shall be included a "SWIVEL BALANCE ADJUSTER" for proper vertical alignment.

For 5-SECTION CLUSTER signal assemblies, ONE Span-Wire Hanger shall be furnished, attached to the top signal section. The configuration shall be FHWA MUTCD TYPE 'S', known as the "dog-house head". At the bottom of the top signal section, a cast-aluminum bracket shall connect with the

arrow side, and with the ball indication side. This bracket shall have a removable, threaded "knockout" plug at each 90-degree turn, to facilitate wiring.

A 2 inch wide ribbed, cast aluminum BOTTOM BRACKET (No. 10 018 or equiv.), having holes 17 inches on-center, shall be used to unify the assembly. (The two sides of the cluster shall be not more than 8 inches apart.)

For 4-SECTION "T" ASSEMBLY, ONE Span-Wire Hanger shall be furnished, together with two cast aluminum brackets. The two red sections shall be not more than 8 inches apart. Tri-studs will not be accepted.

Mast Arm Mounting

Unless otherwise shown on the plans, rigid signal head mounting brackets shall be used. The bracket shall consist of a top- and bottom-arm, an extruded aluminum vertical tube, a vertical tube clamp, and a mast-arm clamp, with all hardware. The Bracket shall be COMPLETELY RUST PROOF, and shall be fully adjustable in all dimensions and angles.

1.1.1.7 Balance Adjuster

When needed, a Balance adjuster shall be aluminum with a 3/4" WEH. It shall be furnished Powder Coated Federal Yellow (13538) and shall have stainless steel bushing, stainless steel hardware, and a stainless steel eye. This item, as part of the furnish contract, shall not come attached to the signal head assemblies.

1.1.2 LED Modules

Provide modules that consist of an assembly that utilizes LEDs as the light source in lieu of an incandescent lamp for use in traffic signal sections. Use LEDs that are AlInGaP technology for red and yellow indications and InGaN for green indications. Install the ultra-bright type LEDs that are rated for 100,000 hours of continuous operation from -40°C to +74°C. Design modules to have a minimum useful life of 60 months, and to meet all parameters of this specification during this period of useful life.

Ensure, unless otherwise stated in these specifications, that each module meets or exceeds the requirements of the Interim Purchase Specification of the ITE July 2005 "VTCSH". (Light Emitting Diode (LED) Vehicular Traffic Signal Modules (hereafter referred to as ITE July 2005 "VTCSH". Arrow displays shall meet or exceed the electrical and environmental operating requirements of ITE July 2007 "VTCSH" of the ITE specifications.

Each LED module supplied shall be as a set from the same manufacturer.

Lamp socket 'Screw-in' type products shall not be allowed for vehicle traffic signals.

Inline fuses shall not be used in the wire from the head to the terminal end. This wire shall not have any splice points

1.1.2.1 Electrical

Provide modules that have maximum power consumption equal to or below the requirements of Table 1. Design the modules to operate from a 60 ± 3 HZ AC line voltage ranging from 80 volts to 135 volts. Ensure that fluctuations of line voltage have no visible effect on the luminous intensity of the indications. Design the module to have a normal operating voltage of 120 VAC, and measure all parameters at this voltage.

Certify that the module has a power factor of 0.90 or greater, and that THD (current and voltage) induced into an AC power line by the module does not exceed 20 percent for modules with power ratings

above 15W, and 40 percent for modules with power ratings of 15W or less. Design the modules onboard circuitry to include voltage surge protection to withstand high repetition noise transients as stated in Section 2.1.6 of NEMA Standard TS-2, 1992. Ensure all wiring meets the requirements of Section 13.02 of the ITE Publication: Equipment and Material Standards, ITE July 2005 "VTCSH". Provide spade terminals appropriate to the lead wires and sized for a #10 screw connection to the existing terminal block in a standard signal head.

Ensure that the module is compatible with signal load switches and conflict monitors. Design the module to provide sufficient current draw to ensure proper load switch operation while the voltage is varied from a regulated 80Vrms to 135 Vrms. Design off-state for green and yellow modules to be 30Vrms or greater, and on-state to be 40Vrms or greater. Also for green and yellow modules, design the voltage decay to 10 Vrms or less to be 100 milliseconds or less. Ensure that the control circuitry prevents current flow through the LEDs in the off state to avoid a false indication.

Design all modules to meet existing SCDOT monitor specifications for the following type of signal monitors: 170 controller/cabinet Type 210, 2010, 2010ECL and 2010ECLIP conflict monitors (including red monitoring and so-called plus features such as dual indication detection and short yellow time detection).

Ensure that the modules and associated onboard circuitry meet Class A emission limits referred to in Federal Communications Commission (FCC) Title 47, Subpart B, Section 15 regulations concerning the emission of electronic noise.

1.1.2.2 Photometric and Chromaticity Requirements

The maintained minimum luminous intensity values for the modules are shown in ITE July 2005 "VTCSH" specifications. Test all ball modules for luminous intensity at 25°C to meet 115% of values in table 2. Design and certify the modules to meet or exceed the maintained minimum luminous intensity values throughout the warranty period based on normal use in a traffic signal operation over the operating temperature range. Test the Red and Green modules for maintained luminous intensity at 74°C using ITE July 2005 "VTCSH" specifications. Use LEDs that conform to the chromaticity requirements of ITE July 2005 "VTCSH" specifications throughout the warranty period over the operating temperature range. Make chromaticity coordinate compliance measurements at 25°C.

1.1.2.3 Physical and Mechanical Requirements

Design the modules as retrofit replacements for installation into standard incandescent traffic sections that do not contain the incandescent lens, reflector assembly, lamp socket and lens gasket. Ensure that installation does not require special tools or physical modification for the existing fixture other than the removal of the incandescent lens, reflector assembly, lamp socket, and lens gasket.

1.1.2.4 Environmental Requirements

Provide modules that are rated for use in the operating temperature range of -40°C (-40°F) to +74°C (+165°F). Ensure that the modules (except yellow) meet all specifications throughout this range. Fabricate the module to protect the onboard circuitry against dust and moisture intrusion per the requirements of NEMA Standard 250-1991 for Type 4 enclosures to protect all internal components.

1.1.2.5 Module Construction

Design the module to be a single, self-contained device with the circuit board and power supply for the module inside and integral to the unit.

Design the assembly and manufacturing process for the module to ensure all internal components are adequately supported to withstand mechanical shock and vibration from high winds and

other sources. Wire the individual LEDs such that a catastrophic loss or the failure of one LED will result in the loss of not more than 20 percent of the signal module light output. LEDs shall be soldered to the circuit board.

1.1.2.6 Materials

Fabricate the lens and signal module from material that conforms to ASTM specifications. Enclosures containing either the power supply or electronic components of the module shall be made of UL94VO flame retardant materials. The lens of the signal module is excluded from this requirement.

1.1.2.7 Module Identification

Permanently mark each module with the manufacturer's name, model number, serial number, date of manufacture, and lot number if applicable. Identifiers shall be clearly understood. A Barcode shall also be incorporated into the label with all identifiers.

Permanently mark the following operating characteristics on the back of the module: rated voltage and rated power in Watts and Volt-Ampere.

If a specific mounting orientation is required, provide permanent markings consisting of an up arrow, or the word "UP" or "TOP" for correct indexing and orientation within the signal housing.

1.1.2.8 Lens

Provide a lens that is integral to the unit with a smooth outer surface and UV stabilized to withstand ultraviolet exposure for a minimum period of 60 months without exhibiting evidence of deterioration. Coat the front of a polycarbonate lens to make it more abrasion resistant. Seal the lens to the module to prevent moisture and dust from entering the module.

Tint the red and yellow lens to match the wavelength (chromaticity) of the LED. Provide a green lens that is either colorless or tinted to match the wavelength (chromaticity) of the LED.

1.1.2.9 12 Inch Arrow

The following specification requirements apply to the 12 inch (300 mm) arrow module only, which is the only size arrow allowed. All general specifications apply unless specifically superseded in this paragraph. Ensure that the arrow module meets specifications stated in ITE 2007 (VTCSH) for arrow indications. Design arrow displays to be LEDs to meet ITE 2007 (VTCSH) specifications. Determine the luminous intensity using the CALTRANS 606 method or similar procedure. <http://itvendors.dot.ca.gov/hq/esc/ctms/ctmsindex600.html>

1.1.2.10 Testing

Provide test results for ball modules from an independent testing laboratory showing wattage and compliance with ITE 2007 (VTCSH) arrow specifications.. Ensure that the LED signal modules tested are typical, average production units.

Burn In

Energize the sample module(s) (a sample of one module minimum) for a minimum of 24 hours, at 100 percent on-time duty cycle, at a temperature of +74°C (+165°F) before performing any qualification testing. Any failure of the module, which renders the unit non-compliant with the specification after burn-in, shall be cause for rejection. All specifications will be measured including, but not limited to:

Photometric (Rated Initial Luminous Intensity)

Measure at +25°C. Measure luminous intensity for red and green modules upon the completion of a 30 minute 100 percent on-time duty cycle at the rated voltage. Measure luminous intensity for yellow modules immediately upon energizing at the rated voltage.

Chromaticity (Color)

Measure at +25°C. Measure chromaticity for red and green modules upon the completion of a 30 minute 100 percent on-time duty cycle at the rated voltage. Measure chromaticity for yellow modules immediately upon energizing at the rated voltage.

Electrical

Measure all specified parameters for quality comparison of production quality assurance on production modules. (rated power, etc.)

Equipment Compatibility

In addition to the test of modules for compatibility with controllers, conflict monitors, and load switches, perform the following test, and certify the results. Connect each signal module to the output of a standard load switch connected to a variable AC voltage supply (95 to 135 VAC). With the load switch "off," vary the AC voltage from 95 Vrms to 135 Vrms, and measure the drop across the module. Readings greater than 15 Vrms are unacceptable.

1.1.2.11 Photometric Maintenance

Provide testing at an independent laboratory for a designated module to be tested for maintained luminous intensity at 25°C once each year during the five-year warranty period.

Notes:

Design signal modules to meet ITE requirements as a minimum throughout the warranty period.
Design signal modules to have a minimum initial intensity equal to 115% of Table 2 at 25°C.
Independent laboratory test reports are required to validate the initial intensity

1.1.3 Signal Backplate

A Signal Backplate constructed of thin strip of polycarbonate material that extends outward from and parallel to a signal face on all sides of a signal housing to provide a background for improved visibility of the signal locations shall be installed on all Signal Heads. Signal backplates shall be appropriate for the size and manufacturer of each signal head and be of monolithic construction. The backplate shall have a 2" retro reflective yellow border (Type XI (eleven) prismatic sheeting) applied, unless noted otherwise. See Standard Drawing for application.

1.1.4 Certification**CATALOG CUTS ARE REQUIRED**

The Vendor shall provide written Certification from the Manufacturer that the latest ITE STANDARDS have been met.

The Vendor shall provide design details and drawings in sufficient detail for complete evaluation and comparison with these Specifications. Any exceptions to these Specifications must be stated in writing at that time.

The Vendor shall provide written specifications (product sheets) for the specific POLYCARBONATE (LEXAN TYPE NO.) formulation that is proposed. Bids shall provide the tests results for the IZOD IMPACT tests.

Housing Type No. _____ or See Attached Letter _____

The Vendor shall provide written TEST RESULTS DEMONSTRATING THE STRENGTH OF THE 3-SECTION SIGNAL HEAD. The test signal shall not have the SCDOT aluminum bearing plate installed. The tests should include static stress and wind tunnel setups.

Sample modules shall be provided for Department approval upon request. The sample modules submitted shall be representative of typical average production units. Samples will not be returned unless requested by the vendor.

The manufacturer of LED Modules shall have previously supplied indications to other states or cities and shall supply a list of these cities and/or states with the bid. The reference shall include name of city or state, contact person and model number of the LED display(s) previously supplied.

Sample modules shall be provided for Department approval upon request. The sample modules submitted shall be representative of typical average production units. Samples will not be returned unless requested by the vendor.

1.1.5 Warranty

The Vendor shall furnish SCDOT a **60 month** warranty from purchase date on equipment, materials, modules and lamps that are provided by the Manufacturer or Vendor as normal trade practice.

Replacement shall be provided within 30 days of receipt of failed equipment at no cost to the Department (including shipping costs). Faulty equipment shall be picked up from the seven signal shops by the vender.

M686.3 PEDESTRIAN SIGNAL HEADS

1.1 Materials

1.1.1 Pedestrian Head Housing

All signal heads shall conform to the specifications of the INSTITUTE OF TRANSPORTATION ENGINEERS (ITE), "Pedestrian Traffic Control Signal Indications" (latest Revision) August 4, 2010. All pedestrian signal heads shall be furnished by the same manufacturer and shall be new and current production models. Pedestrian signal heads of the size, type, and arrangement specified, are to be furnished, together with ALL the necessary hardware for make-up and mounting. For the purpose of this Specification, the basic material requirements are listed below:

1.1.1.1 General

All pedestrian signal heads shall use a SOLID display LED HAND/MAN module as a light source; a nominal message bearing surface of 16 inches; and SYMBOLIC MESSAGES; the Portland Orange UPRIGHT HAND for "Don't Walk", and Lunar White WALKING MAN for "Walk" OR a countdown display with a nominal message bearing surface of 16 inches with a SOLID SYMBOLIC MESSAGE Hand/Man overlay on the left and the countdown on the right. The Module and the Housing shall be two separate pieces.

1.1.1.2 Housing, Visor

The housing shall be a one piece ultra-stabilized, permanently colored, flame-retardant, PURE Polycarbonate resin. The materials and construction used shall comply with ITE specifications (latest Revision) August 4, 2010. A single housing shall contain the LED module. A weather tight neoprene gasket shall be provided. All Housing hardware shall be stainless steel or aluminum. The terminal strip shall be a minimum 4 position, double row, tinned over brass with zinc plated #10 steel screws. The DOOR shall swing down with two hidden hinges at the bottom, with removable locking pins. The DOOR shall be a corrosion resistant, powder coated, one-piece aluminum alloy die-casting, and pins.

A visor shall also be furnished and shall be securely fastened with stainless steel screws to the front of the signal housing, to shield the lens from the sun.

1.1.1.3 Finish

The finish colors shall be FEDERAL YELLOW (13538) for the door, housing, and exterior surfaces of the visor; and FLAT BLACK (37038) for the inside of the visor and for the part of the door within the visor.

1.1.1.4 Mounting

Pedestrian Heads must fit with brackets and related hardware described below for properly installing the pedestrian signal heads.

For *single post-top mount*:

A 1½" aluminum post top signal mounting shall be furnished. It shall consist of a slip fitter assembly for a one-way signal. It should be Pelco Product Part Number SE-3037 or equivalent with a FEDERAL YELLOW finish. See Diagram 1.

For *dual post-top mount*:

A 1½” aluminum post top signal mounting shall be furnished. It shall consist of a slip fitter for 1- and 2-way signal heads with a 4 inch slip-fitter bracket with a set screw, a lower mounting assembly, a support tube, and an upper mounting assembly. This mounting assembly should be Pelco Product Part Number SE-3257 or equivalent with a FEDERAL YELLOW (13538) finish. See Diagram 2.

**Diagram 1.
Single Post-
Top Mount**

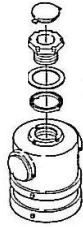

**Diagram 2.
Dual Post-Top
Mount**

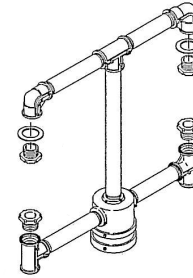

For **side-of-pole mount**:

A CLAMSHELL mount shall be furnished, compatible with a 4-1/2 inch and larger pole. The clamshell mount shall be compatible with either bolt mounting (to a wood pole), or band-on mounting to a steel pole. The side-mount shall make provisions for a hinge, and for wiring and terminal block. All hardware shall be tamper resistant. See Diagram 3.

A 1½” aluminum side-of-pole signal mounting shall be furnished. It shall consist of hub plates with conduit openings, and upper and lower arm assemblies for a 1-way signal. This mounting assembly should be Pelco Product Part Number SP-5523 or equivalent with a FEDERAL YELLOW (13538) finish. See the Diagram 4.

**Diagram 3.
Clamshell Mount**

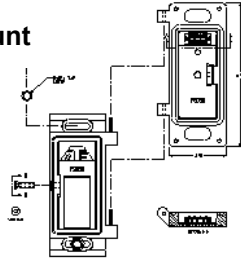

**Diagram 4.
Side-of-pole Mount**

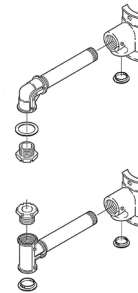

Locking devices equivalent to serrated washers shall be furnished with each type of mounting brackets, so that the pedestrian signal heads may be firmly and positively held in their required alignment.

1.1.2 Hand/Man LED Module and Hand/Man COUNTDOWN LED Module

Each LED module supplied shall be factory installed in the pedestrian signal head or shipped as a complete module with weather tight neoprene gasket to retrofit existing SCDOT polycarbonate pedestrian signal heads if applicable. Design the LED pedestrian signal module for installation into existing standard pedestrian signal head. All signal heads shall conform to the specifications of the INSTITUTE OF TRANSPORTATION ENGINEERS (ITE), "Pedestrian Traffic Control Signal Indications" (latest Revision) August 4, 2010

Identify each module with the manufacturer’s name, model number, serial number, date of manufacture, and lot number if applicable per “The Equipment and Materials Standards” of the Institute of Transportation Engineers “Vehicular Traffic Control Signal Heads”. The Identifiers shall be clearly understood with no need to decipher. A Barcode shall also be incorporated into the label with all identifiers.

The lens shall be a clear, non-glare, non-frosted polymeric lens with a matte finish. It shall be UV stabilized to withstand ultraviolet exposure for a minimum period of 60 months without exhibiting evidence

of deterioration. Coat the front surface of a polycarbonate lens to make it more abrasion resistant. Ensure that the lens has light transmission properties equal to or greater than 80%.

1.1.2.1 Optical

Comply with “The Equipment and Materials Standards” of the Institute of Transportation Engineers “Vehicular Traffic Control Signal Heads.

LED Hand/Man Module

Provide **16 inch displays** that have SOLID Symbolic Messages that meet the dimension requirements cited in Chapter 3, Table 1 Symbol Message for Class 3 displays (minimum 11 inches high and 7 inches in width each). Configure the pedestrian signal module with a sufficient number of LEDs to provide an average luminous intensity which meets the specifications of the ITE specifications (latest Revision) August 4, 2010. Ensure they meet this average luminous intensity throughout the warranty period over the operating temperature range. Wire the LEDs such that a catastrophic loss or failure of one or more LEDs will result in the loss of not more than five percent of the pedestrian signal module light output.

LED Hand/Man Countdown Module

Provide **16 inch displays** that have SOLID Symbolic Messages that meet the dimension requirements cited in Chapter 3, Table 1 *Symbol Message* for Class 3 displays. Ensure that the countdown number display is a minimum of 7 inches high by 6 inches wide. Configure the pedestrian signal module with a sufficient number of LEDs to provide an average luminous intensity which meets the specifications of the ITE specifications (latest Revision) August 4, 2010. Ensure they meet this average luminous intensity throughout the warranty period over the operating temperature range. Wire the LEDs such that a catastrophic loss or failure of one or more LEDs will result in the loss of not more than five percent of the pedestrian signal module light output.

Design the countdown display as a double row of LEDs, and ensure the countdown display blanks-out during the initial cycle while it records the countdown time. Ensure that the countdown display is operational only during the flashing don't walk, clearance interval. Blank out the countdown indication after it reaches zero until the beginning of the next flashing don't walk indication, and design the controlling circuitry to prevent the timer from being triggered during the solid hand indication.

Provide **certification with the bids** for evaluation that the pedestrian signal module complies with the ITE specifications (latest Revision) August 4, 2010. Provide **with the bids**, written independent testing laboratory results showing that the pedestrian signal modules meet or exceed the luminous intensity requirements of ITE specifications (latest Revision) August 4, 2010.

Portland Orange LEDs for the hand and countdown shall be of the latest AllnGaP technology or higher and Lunar White LEDs for the man shall be of the latest InGaN technology or higher. All modules shall be ETL certified and on the ETL certification program.

1.1.2.2 Electrical

Ensure that LED modules are compatible with signal load switches and conflict monitors meeting NEMA Standard TS 1 - 1989. Design the module to provide sufficient current draw to ensure proper load switch operation while the voltage is varied from a regulated 80Vrms to 135Vrms. Provide control circuitry to prevent current flow through the LEDs in the off state to avoid a false indication. Design all modules to meet existing SCDOT monitor specifications for the following types of signal monitors: 170 cabinet/controller compatible SCDOT specified Type 210, Type 2010, Type 2010ECL, and Type 2010ECL-ip conflict monitors (including red monitoring and so-called plus features such as dual indication detection and short yellow time detection).

Provide lead wires that are eighteen gauge (18AWG) minimum copper conductors with 105 degree Celsius insulation and also be anti-capillary. There shall be no more than three lead wires exiting the unit with no external splices. Lead wires shall be a minimum of 36 inches long with NEMA "Locking spade" terminals that are appropriate to the lead wires and sized for a #10 screw connection to the existing terminal block in the pedestrian signal head.

The LED's shall be soldered to the circuit board.

Ensure that the power consumption for the pedestrian signal modules is equal to or less than the following in watts, and that the modules have EPA Energy Star compliance ratings, it applicable to the shape, size and color.

TEMPERATURE	25°C	74°C
HAND	10	12
MAN	9	12
COUNTDOWN	9	12

1.1.3 Packaging

Each single pedestrian signal head, complete with visor and LED specified, completely assembled and designated mounting assembly, shall be packaged in a separate corrugated cardboard box. It shall be clearly labeled on the END of the box, in English, as to the type of mounting assembly contained therein. Manufacturer shall provide a packing list with the serial number(s), date(s) of manufacture, and lot number(s) if applicable.

Each style of retrofit module complete with weather tight neoprene gasket shall be packaged in a separate corrugated cardboard box. It shall be clearly labeled on the END of the box, in English.

1.1.4 Certification

Provide **with the bids**, written Certification from the intended Manufacturer, that ITE specifications (latest Revision) August 4, 2010 have been met for heads and modules.

The manufacturer shall have previously supplied indications to other states or cities and shall supply a list of these cities and/or states with the bid as references. The references shall include name of city or state, contact person, phone number, and model number of the LED display(s) previously supplied. Failure to submit references upon request shall be grounds for refection of the bid.

The Vendor SHALL FURNISH, the design details and drawings in sufficient detail for complete evaluation of the Proposal, and comparison with these Specifications. Any exceptions to these Specifications must be stated in writing at that time.

Sample modules shall be provided for Department approval upon request. The sample modules submitted shall be representative of typical average production units. **Samples will not be returned unless requested by the vendor.**

NOTE: CATALOG CUTS ARE REQUIRED AT BID OPENING.

1.1.5 Warranty

During the period of **60 months** following the date of Delivery, the Manufacturer or Vendor shall replace, at no expense to the Department (including shipping costs), any part of Polycarbonate Pedestrian Signal Head that fails by reason of defective material or workmanship. The Manufacturer or Vendor shall be responsible for pickup and delivery to the seven district signal shops and shall be within 150 miles of Columbia, South Carolina.

Performance shall be warranted for a period of **60 months** of the date of delivery and shall include repair or replacement of an LED pedestrian module that exhibits light output degradation which in the judgment of the department, cannot be easily seen at 150 feet in bright sunlight with the visor on the housing or that drops below the luminous intensity output requirements of sections 3.2 and 3.3 of this specification. Failure due to workmanship, materials, and manufacturing defects shall be warranted for repair or replacement of the first 60 months of the date of delivery. The vendor shall replace any failed modules within 30 calendar days of notification.

M686.4 PEDESTRIAN PUSH BUTTON STATION ASSEMBLY WITH SIGN

1.1 Description

These items consists of furnishing AMERICAN DISABILITIES ACT APPROVED ALUMINUM PEDESTRIAN PUSH BUTTON STATION ASSEMBLIES AND PUSH BUTTON SIGNS of the types, sizes, and mounting specified, in accordance with these Specifications. All PUSH BUTTON STATION ASSEMBLIES AND PUSH BUTTON SIGNS shall be supplied with the appropriate mounting hardware.

1.2 Materials

1.2.1 Aluminum Push Button Station Assemblies

Each aluminum push button station assembly shall conform to the specifications as set forth by the AMERICAN DISABILITIES ACT (ADA). Each aluminum push button station assembly shall be provided with an adjoining sign and must be able to accommodate to the size of the specified sign (either 9 x 12 inch or 9 x 15 inch).

1.2.2 Dual Mount Bracket

A single dual mounting bracket shall be provided to allow for two push button station assemblies to be mounted on one pole with the buttons positioned below the sign.

1.2.3 Push Buttons (with or without adjoining sign)

The long life switch shall be actuated by a 2 inch diameter chrome plated button and shall be included into a vandal resistant one-piece cast aluminum assembly and include a cable guide. Any exposed screws on the push button station assembly shall be stainless steel or other rust resistant material, and be tamper-proof. There shall be no sharp edges. All Push buttons shall be non-latching solid state with tone.

1.2.4 Finish

The finish color shall be FEDERAL YELLOW (13538) for the aluminum push button station assembly The push button shall operate on a circuit not to exceed 24 Volts.

1.2.5 Push Button Signs

Each aluminum push button station assembly shall be provided with an adjoining sign.

The push button sign shall be aluminum with minimum thickness of 0.1 inch, with rounded corners, and have a black legend on white background. **The message shall be in accordance with the MANUAL ON UNIFORM TRAFFIC CONTROL DEVICES FOR STREETS AND HIGHWAYS (latest edition).**

The signs shall be 9 x 12 inch for:

R10-4a "PUSH BUTTON FOR GREEN LIGHT" when used without Pedestrian Signal Heads (see diagram below)

R10-3b "TO CROSS PUSH BUTTON (MAN WALK SYMBOL W/DEFINITIONS) ← → (arrow-left/right)" when used with hand/man Pedestrian Signal Heads The sign shall be reversible, such that one side displays the message with a left arrow and the other side displays the message with a right arrow (see diagram below).



R10-4a



R10-3b

or should be 9 x 15 inch for:

R10-3e "TO CROSS PUSH BUTTON (COUNTDOWN)" when used with countdown Pedestrian Signal Heads The sign shall be reversible, such that one side displays the message with a left arrow and the other side displays the message with a right arrow (see diagram below).



R10-3e

1.2.6 Certification

CATALOG CUTS ARE REQUIRED

Provide written Certification from the intended Manufacturer, that ADA SPECIFICATIONS have been met for push buttons.

Provide design details and drawings sufficiently detailed. This is necessary for a complete evaluation of the Proposal, and comparison with these Specifications. Any exceptions to these Specifications must be stated in writing at that time.

Samples of each of the aluminum Pedestrian Push Button Station Assemblies and Signs shall be for Department approval upon request. The samples submitted shall be representative of typical average production units. **Samples will not be returned unless requested by the vendor.**

1.2.7 Warranty

During the period of **12 months** following the date of purchase, the Manufacturer or Vendor shall replace, at no expense to the Department (including shipping costs), any part of the Pedestrian Push Button Station Assembly, Sign or Bracket that fails by reason of defective material or workmanship.

1.3 Measurement

Furnishing a Pedestrian Push Button Station Assembly and Sign will be measured by EACH unit, including all dual mounting brackets and incidental hardware.

Furnishing a Sign will be measured by EACH unit.

1.4 Payment

Furnishing a Pedestrian Push Button Station Assembly and Sign, measured as provided above, will be paid for at the contract unit price bid for:

FURNISH PEDESTRIAN PUSH BUTTON SOLID STATE WITH TONE TYPE STATION ASSEMBLY (9"x12") AND SIGN (R-10-3E)	EA
FURNISH PEDESTRIAN PUSH BUTTON SOLID STATE WITH TONE TYPE STATION ASSEMBLY (9"x15") AND SIGN (R-10-3E)	EA
FURNISH PEDESTRIAN PUSH BUTTON SOLID STATE WITH TONE TYPE	EA
FURNISH DUAL MOUNTING BRACKET FOR (9 X 15 inch) SIGN	EA
FURNISH 20' SPUN ALUMINUM PEDESTRIAN POLE 4 ½" DIAMETER	EA

For Signs:

FURNISH SIGN R10-3 (PUSH BUTTON FOR GREEN LIGHT)	EA
FURNISH SIGN R10-3b "TO CROSS PUSH (MAN/WALK SYMBOL WITH DEFINITIONS)" REVERSABLE FOR ARROWS IN BOTH DIRECTIONS	EA
FURNISH SIGN R10-3e "TO CROSS PUSH BUTTON (COUNTDOWN - ARROW)" REVERSABLE FOR ARROWS IN BOTH DIRECTIONS	EA

M686.5 SYMBOLIC LED BLANKOUT SIGN

1.1 Description

This specification describes requirements for furnishing Symbolic LED (Light Emitting Diode) No Right/Left Turn Blankout Sign, of Clam-Shell configuration, with Sun Visor and designated mounting hardware. The Blankout Sign and the mounting hardware are stated as one item.

1.2 Materials

1.2.1 Blankout Sign

All Blankout Signs shall be built to Institute of Transportation Engineers "Vehicular Traffic Control Signal Heads" (VTCSH) standards. All Blankout Sign housings shall be furnished by the same manufacturer and shall be new and current production models. The Blankout Sign shall be capable of displaying three distinct messages including blank message. The furnished Blankout Sign shall include all electrical and electronic hardware, structural materials, housings, and all the necessary hardware for make-up and mounting. The Blankout Sign, and its associated equipment, shall be capable of operating on a 24 hour a day, 7 day per week basis and shall conform to the physical and functional requirements of this Specification.

1.2.1.1 Symbol

All blankout signs shall use an illumination of International Symbol consisting of a red circle and slash and either a white right arrow or white left arrow. Symbols shall conform to MUTCD sign standards. When the display is not energized, the sign shall be effectively blank. The Symbol shall be illuminated by an assembly of high output lunar white and red LEDs.

1.2.1.2 Housing

The housing shall be a constructed of Aluminum and shall be weatherproof. The outside dimensions shall not be less than 26 inches high by 26 inches wide and 4 inches deep. The housing shall not be less than 0.125 inch aluminum with all corners being welded their full length. All welds shall use the tungsten inert gas method. A fitting shall be installed on the bottom of the sign in the middle for tethering. The back shall be aluminum of not less than 0.063 inches thick. The door shall be extruded aluminum of not less than 0.125 inch thickness and shall be welded on two corners and screwed together on the other two corners to provide access for installation of a faceplate and polycarbonate lens. The aluminum door shall be attached to the housing utilizing stainless steel hinges. The door shall be held secure to a neoprene gasket by stainless steel, quarter turn link locks. All hardware shall be stainless steel and no tools shall be required for routine maintenance. A retaining rod shall be provided to secure the door in the open position.

1.2.1.3 Visor

A three sided aluminum visor of not less than 0.063 inch thickness and 7 inches deep shall also be furnished and shall be securely fastened with corrosion resistant screws to the aluminum door, to shield the lens from the sun.

1.2.1.5 Finish

The finish colors shall be FEDERAL YELLOW (13538) for the door, exterior and interior of the sign enclosure, and exterior surfaces of the visor. Apply the yellow by the dry powder method. Apply the yellow finish by electrostatic spray and heat cure. Ensure the thickness of the finish is a minimum of 2.5 mils thick. Do not apply paint to the latching hardware. Paint two coats of FLAT BLACK (37038) for the inside of the visor, and for the part of the door within the visor.

1.2.1.6 Mounting

All mounting hardware shall be furnished for Span-Wire mounting, as requested by the purchase order. Hardware for Span-Wire shall be finished FEDERAL YELLOW (13538).

For Span-Wire mounting, the HANGER shall be cast ALUMINUM, and shall contain two (2) stainless steel J-Hooks with stainless steel lock washers and nuts, and have seven (7) notches to position the hanging signal. A double weatherhead entrance shall be used. The weatherhead entrance BUSHING shall have a 1.5 inch hole for wire entry. That entrance diameter shall be maintained throughout the weatherhead, without restriction or reducing the hole diameter, into the sign. No special tools shall be required to tighten or adjust signs. Span wire hangers shall not require disassembly to install on span wire.

A fastener shall be installed in the bottom of the sign housing to provide for attachment to a tether cable of ¼ inch diameter.

1.2.2 *Symbolic LED Module*

Provide a symbolic display that is a PCB (Printed Circuit Board) matrix with a mat black solder mask with minimum thickness of 0.093 inches and a silk screened component identifier. Mount LEDs on front of the PCB matrix. Mount all other components on the back of the black matrix. Ensure that a person with 20/20 vision can read a fully intensified, legible message from 500 feet in front of the sign under any light conditions. Ensure the message is not legible when the sign is off, even if in direct sunlight.

Design and certify the LED Blankout Sign to operate over a temperature range of –40°F to 165°F with an operating voltage range of 105 to 130 volts and a power factor >95%. Ensure that all electronic components are standard industry items that are available from wholesale electronics distributors. Provide components that are “solid state” type. Do not use electro-mechanical components such as relays, transformers or solenoids.

Ensure compatibility and proper triggering and operation with load switches and conflict monitors in signal controllers currently used by the Department. Ensure the on-board circuitry meets FCC title 47, sub-part B, section 15 regulations on the emission of electronic noise. The presence of ambient radio signals, magnetic or electromagnetic interference, including those from power lines, roadway lights, transformers or motors, within 1 foot of any of the components of the Blankout Sign, shall not impair the performance of the Blankout Sign. The Blankout Sign shall not radiate any electrical or electromagnetic signals that could adversely affect any other electrical or electronic device.

1.2.2.1 LED Specifications

Use Red LEDs that are the latest Aluminum Indium Gallium Phosphide (AlInGaP) technology and White LEDs that are the latest Indium Gallium Nitride (InGaN) technology or better with a minimum luminous output requirement of 9,000 candelas per meter square when each discrete LED is driven at a current of 20 milliamperes. Install the ultra-bright type LEDs that are rated for 100,000 hours of elapsed time calendar hours use in an ambient temperatures, based on an average daily on-time usage factor of 11%, when driven at the specific forward current used for normal daylight LED Blankout Sign display

operation. Distribute the LEDs evenly. Ensure that the maximum distance, center to center, between consecutive LEDs is 0.5 inches, plus or minus 10%. Connect the individual LED light sources so that failure of a single LED will result in a loss of no more than 5 LEDs. Protect and seal the rear side of the PCB with a molded polymeric back cover. Mount the display PCB with back cover into the front door, which consist of an aluminum frame and face lens.

The LED driver electronics shall not be mounted on the same board as the LED displays. The driver boards shall be easily disconnected from the LED display modules. Removal of any display module shall not affect the operation of the remaining modules.

1.2.2.2 Lens

Provide a clear, non-glare, mat finish polycarbonate lens with a UV resistant surface treatment and super abrasion resistant properties. Ensure that the lens has light transmission properties equal to or greater than 80%. The module shall be completely sealed against moisture and dust intrusion.

1.2.2.3 Dimming

Provide a photocell and dimming circuitry to automatically reduce the light intensity of the display by 35% based on the ambient light to reduce long term degradation of the LEDs. Include a 30-second delay to prevent interference caused by extraneous light.

1.2.2.4 Labels

Identify each Symbolic LED Module with the manufacturer's name, model number, serial number, date of manufacture, and lot number if applicable.

1.2.3 Packaging

Each single Symbolic Blankout Sign, complete with visor, and LED Symbolic module capable of displaying either a right or left arrow, as specified, completely assembled with mounting assembly and tether fastener, shall be packaged in a separate corrugated cardboard box. The box shall be clearly labeled on the END of the box, in plain English, as to what's contained therein. All packages shall be identified with the Department PURCHASE ORDER NUMBER. Packing lists and EQUIPMENT LABELS shall be glued to every carton showing its contents.

Each Symbolic LED Module shall be packaged in a separate corrugated cardboard box. The box shall be clearly labeled on the END of the box, in plain English, as to what's contained therein. All packages shall be identified with the Department PURCHASE ORDER NUMBER. Packing lists and EQUIPMENT LABELS shall be glued to every carton showing its contents.

1.2.4 Certification

CATALOG CUTS ARE REQUIRED

Provide written Certification from the **Manufacturer or Vendor** that ITE Standards, MUTCD standards, and all the requirements of this specification have been met.

Samples shall be provided for Department approval if requested. The sample submitted shall be representative of typical average production units. Samples will not be returned unless requested by the vendor.

1.2.5 Warranty

During the period of **SIXTY (60) MONTHS** following the date of purchase, the Manufacturer or Vendor shall replace, at no expense to the Department (including shipping costs), any part of Symbolic LED Blankout Sign that fails by reason of defective material or workmanship.

Performance shall be warranted for a period of **SIXTY (60) MONTHS** of the date of purchase and shall include repair or replacement of a Symbolic LED NRT/NLT Module that exhibits light output degradation, which in the judgment of the department, cannot be easily seen at one hundred fifty feet (150') in bright sunlight with the visor on the housing or that drops below the luminous intensity output requirements of this specification. The vendor shall replace any failed modules within 30 calendar days of notification.

1.3 Measurement

Furnishing a No Right/Left Turn Symbolic LED Blankout Sign shall be measured by EACH with LED module installed, including ALL internal electrical and electronic hardware, structural materials, housings, and all the necessary hardware for proper mounting.

Furnishing a No Right/Left Turn Symbolic LED Module, measured by each, shall be complete with weather tight neoprene gasket for replacing defective existing modules if applicable.

1.4 Payment

Furnishing a No Right/Left Turn Symbolic LED Blankout Sign with LED module with span wire mount, measured as provided above, will be paid at the contract unit price bid for:

FURNISH NO RIGHT/LEFT TURN SYMBOLIC LED BLANKOUT SIGN W/ SPAN WIRE MOUNTING	EA
---	----

Furnishing a Symbolic LED module, measured as provided above, will be paid at the contract unit price bid for:

FURNISH NO RIGHT/LEFT TURN SYMBOLIC LED MODULE	EA
--	----

M688.3 VIDEO DETECTION SYSTEM

1.1 Description

This specification describes requirements for furnishing video detection system components with all necessary hardware and software and includes the Network Security Policy as part of this specification. A complete Video Detection System includes Camera, Camera Mounting Hardware, Camera Cable, CPU, Surge Arrestors, and Power Panel.

1.2 Materials

1.2.1 Video Imaging

Material and equipment furnished under this section must be pre-approved by SCDOT by the date of installation. Miscellaneous hardware such as cables and mounting hardware do not need to be pre-approved.

Ensure that software is licensed for use by SCDOT and by any other agency responsible for maintaining or operating system.

Design and furnish video detection systems that detect vehicles at signalized intersections by processing video images and providing detection outputs to the signal controller in real time (within 150 milliseconds of vehicle arrival).

Furnish all required camera sensor units, processor units, hardware and software packages, cabling, luminaire arms, harnesses, camera mounting assemblies, surge protection panels, grounding systems and all necessary hardware. Furnish systems that allow the display of detection zones superimposed on an image of the roadway on an SCDOT-furnished monitor or laptop computer screen. Ensure detection zones can be defined and data entered using a simple keyboard or mouse and monitor, or using a Windows® Xp (or newer) based laptop PC with software.

Provide design drawings showing design details and camera sensor unit locations for review and acceptance before installation. Provide mounting height and location requirements for camera sensor units on the design, based on site-survey. Design video detection systems with all necessary hardware. Indicate all necessary poles, spans, mast arms, luminaire arms, cables, camera mounting assemblies and hardware to achieve the required detection zones where SCDOT owned poles are not adequate to locate the camera sensor units. The vendor is responsible for the final design of video detection systems.

Review and acceptance of the designs by SCDOT does not relieve the vendor from the responsibility to provide fully functional systems and to ensure that the required detection zones can be provided.

Provide the ability to program each detection call with the following functions:

- Full Time Delay – Delay timer is active continuously,
- Normal Delay – Delay timer is inhibited when assigned phase is green (except when used with TS 2 and 170/2070L controllers),
- Extend – Call is extended for this amount of time after vehicle leaves detection area,

- Delay Call/Extend Call – This feature uses a combination of full time delay and extend time on the same detection call. Ensure operation is as follows: Vehicle calls are received after the delay timer times out. When a call is detected, it is held until the detection area is empty and the programmed extend time expires. If another vehicle enters the detection area before the extend timer times out, the call is held and the extend timer is reset. When the extend timer times out, the delay timer has to expire before another vehicle call can be received.

Provide the ability to program each detection zone as one of the following functions:

- Presence detector,
- Directional presence detector,
- Pulse detector,
- Directional pulse detector.

Ensure previously defined detector zones and configurations can be edited.

Provide systems that allow for the placement of at least 8 detection zones within the combined field of view of a single camera sensor unit.

Provide a minimum of 4 detection outputs per processing unit. If additional outputs are needed, provide all necessary hardware to allow for additional calls to be placed to the Controller via the input file.

Provide detection zones that can be overlapped. Ensure systems reliably detect vehicles when the horizontal distance from the camera sensor unit to the detection zone area is less than ten times the mounting height of the sensor. Ensure systems detect vehicles in multiple travel lanes.

Ensure systems can detect vehicle presence within 98 to 102 percent accuracy (up to 2 percent of the vehicles missed and up to 2 percent of false detection) for all weather and lighting conditions, in the absence of occlusion.

SCDOT may conduct field-testing to ensure the accuracy of completed video detection systems.

1.2.2 Video Detection System

Furnish video detection systems that receive and simultaneously process information from camera sensor units, and provides detector outputs to signal controllers.

Ensure systems provide the following:

- Operate in a typical roadside environment and meet the environmental specifications and are fully compatible with NEMA TS 1, NEMA TS 2, or Type 170/2070L controllers and cabinets,
- provide a “fail-safe” mode whereby failure of one or more of the camera sensor units will cause constant calls to be placed on the affected vehicle detection outputs to the signal controller,
- provide compensation for minor camera movement of up to 2 percent of the field of view at 400 feet without falsely detecting vehicles,
- process the video at a minimum rate of 30 frames per second,
- provide separate wired connectors inside the controller cabinet for viewing each camera,

Furnish camera sensor units that comply with the following:

- have an output signal conforming to EIA RS-170 standard,

- have a nominal output impedance of 75 ohms,
- be immune to bright light sources, or have built in circuitry or protective devices to prevent damage to the sensor when pointed directly at strong light sources,
- be housed in a light colored environmental enclosure that is water proof and dust tight, and that conforms to NEMA-4 specifications or better,
- simultaneously monitor at least five travel lanes when placed at the proper mounting location with a zoom lens,
- have a sunshield attached to the environmental enclosure to minimize solar heating,
- meet FCC class B requirements for electromagnetic interference emissions,
- have a heater attached to the viewing window of the environmental enclosure to prevent ice and condensation in cold weather,
- have the Video Processing unit in the cabinet.

Where coaxial video cables and other cables are required between the camera sensor and other components located in the controller cabinet, furnish surge protection in the controller cabinet.

Coaxial communications cable shall comply with the following, as recommended by the manufacturer:

- Belden 8281 or approved equivalent Number 20 AWG, solid bare copper conductor terminated with crimped-on BNC connectors (do not use BNC adapters) from the camera sensor to the signal controller cabinet.
- Belden 9259 or approved equivalent Number 22 AWG, stranded bare copper conductor terminated with crimped-on BNC connectors (do not use BNC adapters) from the camera sensor unit to the junction box, and within the signal controller cabinet.

Furnish power cable appropriately sized to meet the power requirements of the sensors. At a minimum, provide three conductor 120 VAC field power cable.

As determined during the site survey, furnish sensor junction boxes with nominal 6 x 10 x 6 inches dimensions at each sensor location. Provide terminal blocks and tie points for power cable.

1.2.3 Video Detection System Support

Furnish video detection systems with either a simple keyboard or a mouse with monitor and appropriate software, or with system software for use on SCDOT-owned laptop PCs. Ensure the system is Windows® 2000 compatible, or newer.

Provide Hardware and Windows® XP compatible (or newer) personal computer software, if needed, to provide remote video and video detection monitoring via standard telephone line.

Provide each individual system with all the necessary equipment to focus and zoom the camera lenses without the need to enter the camera enclosure.

Ensure systems allow the user to edit previously defined detector configurations. When a vehicle is within a detection zone, provide for a change in color or intensity of the detection zone perimeter or other appropriate display change on the monitor or laptop computer screen.

Provide cabling and interconnection hardware with 6-foot minimum length interconnection cable to interface with the system.

Provide all associated equipment manuals and documentation.

1.2.4 *Fisheye Video Detection*

The system shall have a modular electrical design and use Ethernet to connect and network with the different system components. The software shall provide graphical user interfaces between the administrator(s) and permissioned users of the system and the system sensor(s). Fisheye video detection minimum requirements are shown below and defined in the following sections.

- Provide real time vehicle detection within 500 milliseconds of vehicle arrival
- Detect the presence of vehicles for up to 64 detections zones per sensor. The detection zones shall be sensitive to the direction of vehicle travel.
- Provide a flexible detection zone placement anywhere within 150 feet of the sensors.
- Provide advanced detection zones 300 feet from a fisheye sensor when mounted a minimum of 40'.
- Provide detection zone settings for point detection (equivalent to the operation of a 6' x 6' inductive loop)
- Detection shall be 98% accurate under adverse weather conditions (rain, snow, fog, etc.)
- Equipment failure shall result in constant vehicle detection on affected detection zones.
- Provide the ability to view the detection area in a horizon to horizon fisheye view or in a configurable four pane flattened view on the same screen.

1.2.4.1 System Hardware

The required hardware shall include the following

- One processor capable of connecting with 1 to 8 sensors. Processor shall comply with NEMA standards, TS1, TS2, Type 1 and Type 2; 170/270; and ITS. The processor shall be no more than 1U high with dimensions, excluding connectors, not to exceed 8.5" x 11.5" x 1.75" and weigh no more than 5.2 pounds. The processor shall have flexible mounting options including the ability to lie flat on a cabinet shelf, be mounted in a standard traffic cabinet rack. The processor shall meet or exceed a 5-30Hz vibration test as well as a 10G shock test. The processor shall operate properly in an environment with 0% to 95% relative humidity, non-condensing. The processor shall operate within a range of 89-240 VAC, 60Hz single phase. The outer enclosure shall be a powdered coated aluminum.
- One sensor with a fisheye lens for omnidirectional viewing.
- One surge protector junction unit and EPM surge protection unit per each sensor in the traffic cabinet. The surge protector junction unit shall provide protection against a transient pulse with a pulse shape of 8/20us and a max current of 75A. The unit shall weigh no more than two (2) pounds.. The EPM surge protection unit shall have a maximum impulse discharge current of 40 KA and an impedance of at least 100 ohms. The unit should have a minimum of Line-Line and Line-Grounds protection options.
- Mounting pole and bracket appropriate for type of sensor to be installed. A ninety degree pole is required for each fisheye sensor and a vertical pole for each advanced/stop line sensor.
- One ball-swivel, bracket, and surge protector junction unit per each fisheye sensor.
- One surge protector per each system sensor.

1.2.4.2 Sensor Hardware

The fisheye sensor is required to provide the following features:

- Downward-facing sensor capable of viewing the center of the intersection and have an omnidirectional line of site to track vehicles entering and exiting the intersection.
- Color images outputted into digital format as MJPEG images.

- Camera lens shall not require adjustment and is always in focus. Manufacturer shall provide a lifetime “always in focus” guarantee.
- A thermostatically controlled heater residing inside the enclosure to reduce the effects of ice and condensation.
- Ultraviolet inhibitor for plastics in the enclosure.
- Waterproof and dust tight aluminum enclosure.
- The sensor dimensions excluding connectors shall not exceed 9.9” height x 7.9” diameter.
- The weight of the sensor including the enclosure shall not exceed eight (8) pounds.
- The sensor junction box shall mount at the base of the vertical pole and allow for the installer to adjust the sensor’s horizontal position with one hand and tighten the bracket without having to support the sensor simultaneously.
- Operate properly in an environment with 0% to 100% relative humidity.
- Use five (5) watts nominally and a maximum of fifty (50) watts with active heaters.
- Power Over Ethernet (POE) with a single shielded, burial grade, gel-filled CAT5e cable for both power and data. POE current shall not exceed 1.8A.

The advance detection sensor is required to provide the following features:

- Stop line detection field of view of thirty degrees to fifty degrees.
- Advanced detection field of view of nine degrees to eighteen degrees.
- Sensor dimensions excluding connectors and mounting bracket shall not exceed 8” x 15” x 3.5”.
- Sensor weight should not exceed eight pounds.
- Color images outputted into digital format as MJPEG images.
- A 5-50 mm varifocal lens
- A thermostatically controlled heater residing inside the enclosure to reduce the effects of ice and condensation.
- A sun shield to minimize lens exposure to the sun.
- A waterproof and dust tight powdered coated aluminum housing.
- Operate properly in an environment with 0% to 100% relative humidity.
- Use five (5) watts nominally and a maximum of fifty (50) watts with active heaters.
- Power Over Ethernet (POE) with a single shielded, burial grade, gel-filled CAT5e cable for both power and data. POE current shall not exceed 1.8A.

1.2.4.3 Cable

Cat5e cabling shall be a high performance shielded direct burial data cable capable of 350 MHz bandwidth for data applications. The cabling shall consist of a 24 AWG solid core copper wire with 8 solid conductors in a gel-filled jacket. The jacket shall consist of linear low density polyethylene that is UV resistant and have a maximum cable diameter of 6.5 mm. The cable shall be rated at a minimum for 60V

Composite fiber cable shall meet the following requirements:

- Multimode, OM3, Indoor-Outdoor rated
- Meet ICEA-S-83-597 Standard
- Four Fiber Strands and two 16 AWG Copper Power Conductors

Fiber cable shall be terminated with FASTconnect LC connectors and maintain a signal strength between -20 dBm and -24 dBm. The fiber cable shall connect to the sensors using POE Media Converters that shall meet the following requirements:

- Material: UV Stabilized, Polycarbonate/ASA Blend
- Environmental: -29 degrees F to 165 degrees F
- IP66

1.2.4.4 Fisheye System Software

The Fisheye System Software is required to provide the following features:

- Provide software for up to six (6) sensors
- Download and operate on any personal computer with a Windows 7 or newer operating system.
- View, diagnose, configure, and reset individual sensor outputs
- View the status of inputs to enable setup and troubleshooting in the field.
- Configure and view call and phases.
- The ability to create, define, and edit vehicle zones and pedestrian zones by drawing arbitrary shaped polygons using a computer.
- Detect and track vehicles, motorcycles, bicycles, and pedestrians through the entire 360 degree field of view.
- Distinguish between bicycles and vehicles in the center of the intersection and provide distinct detector calls to the traffic controller for each object type.
- Provide system calls based on zone occupancy.
- View the site's configuration history.
- Publish and revert back to previous configuration.
- View real-time image streaming from the sensor(s) within the software's interface.
- Provide system alerts for diagnostic and administrative events.
- process the video at a minimum rate of 10 frames per second,

1.2.5 *Warranty*

The Vendor shall furnish SCDOT with any warranties on equipment and materials that are provided by the Manufacturer or Vendor as normal trade practice.

1.3 Measurement

Furnishing Video Detection System components shall be measured as EACH unit.

Furnishing Video Detection Camera Cable shall be measured by LINEAR FEET and furnished in 500' REELS or 1000' REELS.

Furnishing Video Detection System On Site Training shall be measured by DAY.

1.4 Payment

Furnishing Video Detection System components, Cable, and On Site Assistance, measured as provided above, will be paid for at the contract unit price for:

FURNISH VIDEO DETECTION CPU	EA
FURNISH VIDEO DETECTION CAMERA	EA
FURNISH VIDEO DETECTION CAMERA MOUNTING HARDWARE	EA
FURNISH VIDEO DETECTION CAMERA CABLE – 1000'	1000' REEL
FURNISH VIDEO DETECTION CAMERA CABLE – 500'	500' REEL
FURNISH MONITOR WITH VIDEO CABLE	EA
FURNISH VIDEO DETECTION ON SITE ASSISTANCE	DAY
FURNISH VIDEO DETECTION SURGE ARRESTORS	EA
FURNISH VIDEO DETECTION POWER PANEL WITH BREAKER	EA
FURNISH VIDEO DETECTION LENS ADJUSTMENT MODULE	EA

** Network Security Policy to follow on the next three pages:

Network Services Security Policy for network attached devices

This policy is subject to change at any time, as deemed necessary by Network Services and/or the ISO.

Last Update Status: *Updated August 27, 2015*

1. Overview

See Purpose.

2. Purpose

This document describes the required minimal security configuration for all networked devices connecting to a production network or used in a production capacity at or on behalf of South Carolina Department of Transportation (SCDOT).

3. Scope

All employees, contractors, consultants, temporary and other workers at SCDOT and its subsidiaries must adhere to this policy. All networked devices connected to SCDOT production networks are affected.

4. Policy

Every active network device must meet the following operational standards (if applicable):

1. No local user accounts are configured on the network device. Network devices must use TACACS+ /Radius/AD for all user authentication.
2. The super user password on the network device must be kept in a secure encrypted form. The network device must have the super user password set to the current production network device password from the device's support organization.
3. The following services or features must be disabled:
 - a. IP directed broadcasts
 - b. TCP small services
 - c. UDP small services
 - d. All source routing and switching
 - e. Any discovery protocols on Internet connected interfaces
 - f. Telnet, FTP, and HTTP services
 - g. Auto-configuration
4. The following services should be disabled unless a business justification is provided:
 - a. Cisco discovery protocol and other discovery protocols
 - b. Dynamic trunking
 - c. Scripting environments, such as the TCL shell
5. The following services must be configured:
 - a. Password-encryption
 - b. NTP configured to a corporate standard source
6. Any routing updates shall be done using secure routing updates.
7. Support for SNMPV3. Use corporate standardized SNMP community strings. Default strings, such as public or private must be removed. SNMP must be configured to use the most secure version of the protocol allowed for by the combination of the device and management systems.
8. Access control lists must be used to limit the source and type of traffic that can terminate on the device itself.

9. Access control lists for transiting the device are to be added as business needs arise.
10. The network device must be included in the corporate enterprise management system with a designated point of contact.
11. Each network device must have the following statement presented for all forms of login whether remote or local:

WARNING TO USERS

This computer system is the property of the South Carolina Department of Transportation (SCDOT) and may only be accessed by authorized users. Unauthorized access, use, misuse, or modification of this computer system or of the data contained herein or data in transit to/from this system constitutes a violation of Title 18, United States Code, Section 1030. SCDOT shall monitor system usage for unauthorized activities. You should have no expectation of privacy in your use of this network, including information stored locally on the hard drive or other media in use with this unit (e.g., floppy disks, USB drives, PDAs and other hand-held peripherals, CD-ROMs, etc.) Any or all activity of this system may be intercepted, monitored, recorded, copied, audited, or inspected by authorized SCDOT personnel. Improper use or criminal activity can lead to administrative disciplinary actions as well as civil and criminal penalties.

ANYONE USING THIS SYSTEM EXPRESSLY CONSENTS TO SUCH MONITORING. LOG OFF OR DISCONNECT IMMEDIATELY IF YOU DO NOT AGREE TO THE CONDITIONS STATED IN THIS WARNING

12. Telnet may never be used across any network to manage a router, unless there is a secure tunnel protecting the entire communication path. SSH version 2 is the preferred management protocol.
13. Any dynamic routing protocols (if any) must use authentication in routing updates sent to neighbors. Password hashing for the authentication string must be enabled when supported. Password will be provided by the SCDOT
14. The network device configuration standard will define the category of sensitive routing and switching devices, and require additional services or configuration on sensitive devices including:
 - a. IP access list accounting
 - b. Device logging
 - c. Incoming packets at the router sourced with invalid addresses, such as RFC1918 addresses, or those that could be used to spoof network traffic shall be dropped
 - d. Router console and modem access must be restricted by additional security controls

5. Policy Compliance**5.1 Compliance Measurement**

The InfoSec team will verify compliance to this policy through various methods, including but not limited to, periodic walk-thru, video monitoring, business tool reports, internal and external audits, and feedback to the policy owner.

5.2 Exceptions

Any exception to the policy must be approved by the InfoSec team in advance.

5.3 Non-Compliance

An employee found to have violated this policy may be subject to disciplinary action, up to and including termination of employment.

6 Related Standards, Policies and Processes

None.

7 Definitions and Terms

None.

8 Revision History

Date of Change	Responsible	Summary of Change
August 1, 2015	NS Policy Team	Reviewed and accepted
August 27, 2015	NS Policy Team	Reviewed and accepted

M688.4 Radar Detection System

1.1 Description

This specification describes the requirements for furnishing a Radar Detection System (RDS) and all necessary hardware and software components. A complete RDS includes a camera, mounting hardware, cables, CPU, surge arrestors and a power panel. The RDS shall interface with a 170 Traffic Signal Controller/2070 Controller.

The Radar Presence Detector (RDS) system will include the following equipment:

- Radar Units (Stop bar radar, Set back radar, Speed/volume side-fire radar)
 - Sensor Outputs
 - Enclosure
- Radar Cabinet Interface
 - System Hardware
 - Interface panel
 - Contact closure input file cards
 - Communication ports
 - Software
- Sensor Cable

1.1.2 Maintenance

- The RDS shall not require cleaning or adjustment to maintain performance.
- The RDS shall not rely on battery backup to store configuration information, thus eliminating any need for battery replacement. Once the RDS is calibrated, it shall not require recalibration to maintain performance unless the roadway configuration changes.

1.1.3 Operating Conditions

- The RDS shall maintain accurate performance in all weather conditions, including rain, freezing rain, snow, wind, dust, fog and changes in temperature and light, including direct light on sensor at dawn and dusk.
- RDS operation shall continue in rain up to 1 in. (2.5 cm) per hour.
- The RDS shall be capable of continuous operation over an ambient temperature range of -40°F to 165.2°F (-40°C to 74°C). The RDS shall be capable of continuous operation over a relative humidity range of 5% to 95% (non-condensing).

1.1.4 Manufacturing

- The RDS shall be manufactured and assembled in the USA.
- The internal electronics of the RDS shall utilize automation for surface mount assembly, and shall comply with the requirements set forth in IPC-A-610C Class 2, Acceptability of Electronic Assemblies.

1.1.5 Certification

- Each RDS shall be certified by the Federal Communications Commission (FCC) under CFR 47, part 15, section 15.249 as an intentional radiator.
- The FCC certification shall be displayed on an external label on each RDS according to the rules set forth by the FCC. The RDS shall comply with FCC regulations under all specified operating conditions and over the expected life of the RDS.

1.1.6 Network Compatibility

RDS must be approved by SCDOT IT Department to reside on SCDOT Traffic Signal Communications Network. For the protection of the SCDOT, all networkable devices are required to be hardened and secured using an industry standard. SCDOT uses the National Institute of Standards and Technology Cybersecurity framework, but recognizes that other comparable frameworks and standards exist.

1.1.7 Warranty

There shall be a two-year warranty provided against material and workmanship defects.

1.2 **Materials**

1.2.1 Radar Detection System (Radar Units, Radar Cabinet Interface, Cable)

- Radar Operating frequency of 24.0 to 24.25 GHz (K-band) utilizing a matrix of radars
- Two half-duplex RS-485 com ports with dedicated detection communication
- Power consumption less than 10 watts @ 9-28 VDC
- Ambient operating temperature: -29°F to 165°F with humidity: Up to 95% RH
- Must have Onboard surge protection
- Weight less than 5 lbs. (2.27 kg)

1.2.2 Radar Unit Types

1.2.2.1 Stop Bar Detection Units

- The RDS shall present real-time presence data in 10 lanes. The RDS shall support a minimum of 16 zones.
- The RDS shall support a minimum of 16 channels.
- The RDS shall be able to detect and report presence in lanes with boundaries as close as 6 ft. (1.8 m) from the base of the pole on which the RDS is mounted.
- The RDS shall be able to detect and report presence in lanes located within the 140 ft. (42.7 m) arc from the base of the pole on which the RDS is mounted.
- The RDS shall be able to detect and report presence for vehicles within a 90-degree field of view.
- The RDS shall be able to detect and report presence in up to 10 lanes.
- The RDS shall be able to detect and report presence in curved lanes and areas with islands and medians.
- The RDS shall work in the 24GHz frequency range, providing 245 MHz of detection bandwidth.

1.2.2.2 Set Back Advance Detection Units

- The Set Back RDS shall provide up to 900' detection zone for trucks, and up to 600' for cars.
- The Set Back RDS shall provide detection at 50' from mounting with a 50' lateral detection zone.
- The Set Back RDS Detection unit shall work in the 10 GHz frequency range or higher.
- The Set Back RDS shall provide continuous tracking from initial detection point to the intersection.
- The Set Back RDS shall provide dynamic Estimated Time of Arrival ETA, to the intersection, providing dilemma zone protection as an optional functionality.

1.2.2.2 Speed/Volume Side-Fire Detection

- The Speed/Volume Side-Fire RDS shall provide detection for speed and volume data collected by lane for minimum of 10 lanes of multi-directional traffic
- The Speed/Volume Side-Fire RDS shall provide detection from 6' from mounting up to 250'

in a 65 degree vertical field of view.

- The Speed/Volume Side-Fire RDS shall work in the 24 GHz frequency range, providing 245 MHz of detection bandwidth.

1.2.3 Radar Unit Properties

1.2.3.1 Sensor Outputs

- The RDS shall support user-selectable zone to channel mapping.
- The RDS shall be able to trigger channels when all selected zones are active.
- The RDS shall be able to combine multiple zones to a channel output, and shall have channel output extend and delay functionality.
- The RDS algorithms shall mitigate detections from wrong way or cross traffic.
- The RDS system shall have fail-safe mode capabilities for contact closure outputs if communication is lost

1.2.3.2 External Properties

- All external parts of the RDS shall be ultraviolet-resistant, corrosion-resistant, and protected from fungus growth and moisture deterioration.

1.2.3.3 Enclosure

- The RDS shall be enclosed in a Lexan EXL polycarbonate.
- The enclosure shall be classified "f1" outdoor weather ability in accordance with UL 746C. The RDS shall be classified as watertight according to the NEMA 250 standard.
- The RDS enclosure shall conform to test criteria set forth in the NEMA 250 standard for type 4X enclosures. Test result shall be provided for each of the following type 4X criteria:
 - External icing (NEMA 250 clause 5.6)
 - Hose-down (NEMA 250 clause 5.7)
 - 4X corrosion protection (NEMA 250 clause 5.10)
 - Gasket (NEMA 250 clause 5.14)
- The RDS shall be able to withstand a drop of up to 5 ft. (1.5 m.) without compromising its functional and structural integrity.
- The RDS enclosure shall include a connector that meets the MIL-C-26482 specification. The MIL-C-26482 connector shall provide contacts for all data and power connections.

1.2.3.4 Radar Design

- The RDS shall be designed with multiple radars, enabling the sensor to provide detection over a large area and to discriminate lanes for stop bar radar and side-fire radar accuracy.

1.2.3.5 Frequency Stability

- The circuitry shall be void of any manual tuning elements that could lead to human error and degraded performance over time.
- All transmit modulated signals shall be generated by means of digital circuitry, such as a direct digital synthesizer, that is referenced to a frequency source that is at least 50 parts per million (ppm) stable over the specified temperature range, and ages less than 6 ppm per year. Any up conversion of a digitally generated modulated signal shall preserve the phase stability and frequency stability inherent in the digitally generated signal.
- The RDS shall not rely on temperature compensation circuitry to maintain transmit frequency stability.
- The bandwidth of the transmit signal of the RDS shall not vary by more than 1% under all specified operating conditions and over the expected life of the RDS.

1.2.3.6 Antenna Design

- The RDS antennas shall be designed on printed circuit boards.
- The vertical beam width of the RDS at the 6 dB points of the two-way pattern shall be 65 degrees or greater. The antennas shall cover a 90-degree horizontal field of view.

- The side lobes in the RDS two-way antenna pattern shall be -40 dB or less.

1.2.3.7 Resolution

- The RDS shall transmit a signal with a bandwidth of at least 245 MHz.

1.2.4 Radar Cabinet Interface

1.2.4.1 System Hardware

- Each RDS shall have a traffic cabinet preassembled backplate or integrated cabinet device with the following:
 - AC/DC power conversion
 - Surge protection
 - Terminal blocks for cable landing
 - Communication connection points
 - Ethernet TCP/IP communication
 - SDLC (Optional) communication
- The preassembled backplate for the RDS shall be a cabinet side mount or rack mount.
- The integrated cabinet device for the RDS shall be a shelf mount with an option to cabinet side mount.

1.2.4.2 Contact Closure Input File Cards

- The RDS shall use contact closure input file cards with 2 or 4 channel capabilities.
- The contact closure input file cards for the RDS shall be compatible with industry standard detector racks.

1.2.4.3 Electrical

- The RDS shall consume less than 10 W.
- The RDS shall operate with a DC input between 10 VDC and 28 VDC. The RDS shall have onboard surge protection.

1.2.4.4 Communication Ports

- The RDS shall have two communication ports, and both ports shall communicate independently and simultaneously.
- The RDS shall support the upload of new firmware into the RDS's over either communication port. The RDS shall support the user configuration of the following:
 - Response delay
 - Push port
- The communication ports shall support a 9600 bps baud rate.

1.2.4.5 RF Channels

- The RDS shall provide at least 8 RF channels so that multiple units can be mounted in the same vicinity without causing interference between them.

1.2.4.6 Verification

- The RDS shall have a self-test that is used to verify correct hardware functionality. The RDS shall have a diagnostics mode to verify correct system functionality.

1.2.4.7 Configuration

- *Auto-configuration.* The RDS shall have a method for automatically defining traffic lanes, stop bars and zones without requiring user intervention. This auto-configuration process shall execute on a processor internal to the RDS and shall not require an external PC or other processor. The auto-configuration process shall work under normal intersection operation and may require several cycles to complete.

- *Manual Configuration.* The auto-configuration method shall not prohibit the ability of the user to manually adjust the RDS configuration. The RDS shall support the configuring of lanes, stop bars and detection zones in 1-ft. (0.3-m) increments. When lanes have variable widths or have variable spacing (e.g. gore between lanes), precise resolution is necessary.

1.2.4.8 Software Compliance

- Software must be licensed for use by SCDOT
- The RDS shall include graphical user interface software that displays all configured lanes and the current traffic pattern using a graphical traffic representation.
- The RDS shall include the ability to do counting and pulsed channels.
- The graphical interface shall be Microsoft Windows compliant.
- The software shall be installed and operate on a SCDOT provided Windows operating system.
- The software shall support the following functionality:
 - Operate over a TCP/IP connection
 - Give the operator the ability to save/back up the RDS configuration to a file or load/restore the RDS configuration from a file
 - Allow the backed-up sensor configurations to be viewed and edited
 - Provide zone and channel actuation display
 - Provide a virtual connection option so that the software can be used without connecting to an actual sensor.
- Local or remote sensor firmware upgradability.

1.2.4.9 Sensor Cable

- The cable shall be the Orion Wire Combo-22042002-PVCGY or an equivalent cable that conforms to the following specifications:
 - 6-conductor cable that attaches to an 8-pin MIL-C-26482 connector
 - The RS-485 conductors shall be 2 twisted pairs.
 - The RS-485 conductors shall have nominal capacitance conductor to conductor of less than 40 pF/ft at 1 kHz.
 - The RS-485 conductors shall have nominal conductor DC resistance of less than 16.7 ohms/1000 ft. at 68°F.
 - The power conductors shall be a twisted pair.
 - The power conductors shall have nominal conductor DC resistance of less than 11 ohms/1000 ft. at 68°F.
 - The entire cable shall be shielded with an aluminum/mylar shield with a drain wire.
 - The cable shall have a diameter of 0.41 in. The power wires in the cable shall be 20 AWG; the communications wires shall be 22 AWG.
 - The cable shall be UV resistant, as per the UL 720 Hour Sunlight Resistance Test

1.3 Measurement

Furnishing and/or Installing Components of a Radar Detection System shall be measured as EACH unit and includes all hardware and cables necessary for installation and operation, and license.

1.4 Payment

6887971	F&I RADAR FOR STOP BAR DETECTION	FURNISH & INSTALL RADAR FOR STOP BAR DETECTION, INC 150' CABLE & MOUNTING HARDWARE	EA
6887972	F&I CAB INT COMP FOR STOP BAR DETECTION	FURNISH & INSTALL CABINET INTERFACE COMPONENTS FOR STOP BAR DETECTION	EA
6887973	F&I RADAR FOR SETBACK DETECTION	FURNISH & INSTALL RADAR FOR SETBACK DETECTION, INC 150' CABLE & MOUNTING HARDWARE	EA
6887974	F&I CAB INT COMP FOR SETBACK DETECTION	FURNISH & INSTALL CABINET INTERFACE COMPONENTS FOR SETBACK DETECTION	EA
6887975	F&I RADAR FOR SPEED/VOLUME DETECTION	FURNISH & INSTALL RADAR FOR SPEED/VOLUME DETECTION INC 150' CABLE & MOUNTING HARDWARE	EA
6887976	F&I CAB INT COMP FOR SPEED/VOLUME DETECT	FURNISH & INSTALL CABINET INTERFACE COMPONENTS FOR SPEED/VOLUME DETECTION	EA
6887977	F&I RADAR DETECTION CABLE TO CROSS RDWAY	FURNISH & INSTALL RADAR DETECTION CABLE TO CROSS ROADWAY	LF

M688.5 STEEL STRAIN POLE AND FOUNDATION

1.1 Description

This specification describes requirements for furnishing a Steel Strain Pole, of the sizes and colors specified. Anchor bolts and all miscellaneous hardware shall be supplied with each pole as required.

All anchor bolt nuts, caps, pole clamps, and miscellaneous pole hardware shall be **BAGGED IN BURLAP** for each pole during shipping. In addition, individual parts shall also be furnished as specified.

1.2 Materials

1.2.1 General

ALL STEEL STRAIN POLES PROVIDED FOR ANY INDIVIDUAL PROJECT SHALL BE FROM THE SAME MAUFACTURER.

Each Steel Strain Pole Assembly shall consist of:

1. A steel Shaft,
2. A steel Anchor Base,
3. Four steel Anchor Bolts with eight nuts,
4. A removable top plate which will bolt to the shaft with a ¼" J-Bolt and attached to a ½" bar that is welded inside the shaft,
5. Four removable anchor bolt Covers,
6. Two adjustable heavy duty Pole Clamps, and
7. Miscellaneous hardware as specified.

1.2.2 Pole Materials

1.2.2.1 Shaft

The design of the shaft will be based on minimum mill certified 55,000 yield strength steel. One of the following steel must be used in the fabrication of the shaft: American Society for Testing and Materials (ASTM): A570-50, ASTM A572-50, ASTM A572-60, ASTM A607-50, ASTM A607-55, ASTM A607-60, ASTM A595-A or ASTM A595-B.

Only one (1) longitudinal weld, and no transverse welds, shall be permitted.

After being formed and welded, the Shaft shall then be longitudinally cold-rolled with sufficient pressure to flatten the weld. Break formed, (multi-sided) poles shall have a minimum of eight (8) sides and a guaranteed mill certified minimum yield of 55,000 Pounds per square inch (PSI).

The Shaft shall have a uniform taper in diameter from base to top of 0.14" per foot. The minimum base diameter and length shall be as specified in the Dimensions Chart.

A reinforced hand hole, complete with frame and cover with a minimum size of 4" x 6 1/2", shall be welded into the Shaft approximately 12" above the base plate at 0 degrees. The frame shall be tapped with a 1/2" - 13 Unified Thread Standard (UNC) for a grounding bolt. Stainless-steel hardware shall be supplied.

A J-hook wire support shall be welded inside near the top of the Shaft.

Round holes shall be provided in EVERY POLE as follows:

- 3" diameter hole, at 6" on-center below pole TOP; at 0 degrees (above hand hole).
- 3" diameter hole, at 6" on-center below pole TOP; at 270 degrees (orientate counter-clockwise).
- 3" diameter hole, at 15 ¼" on-center above pole BOTTOM; at 90 degrees (orientate counter-clockwise).
- 1" diameter hole, at 35" on-center above pole BOTTOM: at 90 degrees (orientate counter-clockwise).
- 1" diameter hole, at 35" on-center above pole BOTTOM: at 270 degrees (orientate counter-clockwise).

The two (2) 3" upper holes are for installing weatherheads w/nipple and the lower 3" hole is to permit the installation of a pole mounted Controller Cabinet. A 3" threaded, half-blind coupling shall be FACTORY WELDED, to the pole surface and protrude ¼" in each hole. The two (2) 1" diameter holes are for mounting the electrical service. These holes shall have a 1" threaded half-blind coupling FACTORY WELDED, to the pole surface and shall be flush mounted. The entire pole coupling shall then be hot dipped galvanized.

1.2.2.2 Anchor Base and Flange Plates

The Anchor Base and flange plates shall be made from ASTM A36 steel.

The Anchor Base shall be square (with rounded corners), and shall be of the size and thickness specified in the DIMENSIONS TABLE below.

The Anchor Base shall be provided with four (4) holes to accept Anchor Bolts. The size of the holes and the bolt circle shall be as specified in the DIMENSIONS TABLE below.

Tapped holes shall be provided for attaching removable Anchor Bolt covers, which shall be provided with stainless steel hex-head bolts.

The Anchor Base shall telescope the Shaft, and shall be secured to the Shaft by two fillet welds. One weld shall be on the inside of the base at the end of the Shaft, and the other shall be on the outside at the top of the base. The welded connection shall develop the full strength of the adjacent cross-section to resist bending action.

1.2.2.3 Anchor Bolts and Nuts

Anchor Bolts shall be steel rods of ASTM A-36 M-55, modified to have a minimum yield point of 55,000 PSI.

Four (4) Anchor Bolts shall be supplied with each pole. The Anchor Bolt size shall be specified in the Dimensions Chart.

Each Anchor Bolt shall be threaded at the top for 10", and shall have a 6" L-bend at the bottom, or a bearing plate as specified on larger pole sizes.

A total of eight (8) nuts and eight (8) flat washers shall be supplied and installed for each pole. Nuts shall be ASTM 563 Grade A. The two (2) nuts per bolt may be either:

- two (2) hex nuts (preferred), or
- one (1) hex nut and one square nut (acceptable).

Note: All other bolts shall be ASTM A325 or A307, (threaded per UNC series).

1.2.2.4 Pole Cap or Top Plate

Each pole shall be supplied with a Cap or top which shall be made from 7 GA. Galvanized steel or from cast aluminum, ASTM B-108; Alloy 356.OT6.

The Pole Cap shall be of a size greater than the pole top diameter and designed to prevent water from entering the top of the pole.

1.2.2.5 Bolt Cover

With each Pole there shall be supplied four (4) removable bolt covers capable of hiding the installed Anchor Bolts and the top nut. The covers shall have a clean-lined modern appearance. They shall attach to the pole with stainless-steel hex-head bolts. Acorn nuts are also acceptable.

1.2.2.6 Pole Clamp

With each Strain Pole there shall be supplied two (2) adjustable Span Wire Clamps. Each span wire clamp shall be constructed of 1/4" x 3" steel minimum, complete with two 7/8" x 4" stud bolts including two (2) lock washers and two (2) hex nuts per stud bolt. Each span wire clamp shall also include a clevis complete with a 7/8" x 3" bolt with one (1) lock washer and one (1) hex nut.

1.2.2.7 Pole Plugs

Plugs, either galvanized or stainless, shall be supplied for all holes in the steel pole. Plugs shall be installed in all un-used holes in the steel pole in a construction project.

1.2.2.8 Foundation Rebar Cage

See Standard Drawing, Poles, 675-115-02 for Foundation Cage details or separate drawing from Standard Drawing, Poles, 675-115-02 as part of this specification. <http://www.scdot.org/doing/technicalPDFs/standardDrawings/675-000-00.pdf>

1.2.3 Dimensions

Strain Poles shall be supplied on a per EACH basis, with dimensions in accordance with the following table:

DIMENSIONS TABLE

GALVANIZED STEEL SHAFT			GALVANIZED STEEL PLATE BASE			ANCHOR BOLTS			
Type	Diameter at Base	Length	Mfr's Standard Gauge	Plate Size	Plate Thickness	Bolt Circle	Bolt Hole Diameter	Diameter X Pole Total Length	Design Load @ Yield
13" X 26'	13"	26'	#3 gauge	19" square	2"	18"	2 3/8"	2"X90" (including L-bend)	5,200 lb.
13" X 28'	13"	28'	#3 gauge	19" square	2"	18"	2 3/8"	2"X90" (including L-bend)	5,200 lb.
13" X 32'	13"	32'	#3 gauge	19" square	2"	18"	2 3/8"	2"X90" (including L-bend)	5,800 lb.

1.2.4 Other Materials

All other hardware or components shall be made of a non-corrosive material, or be of the same material as the item being installed.

1.2.4.1 Concrete

The concrete used in the pole base, shall conform to the requirements of SCDOT STANDARD SPECIFICATIONS FOR HIGHWAY CONSTRUCTION, Section 701, 702, 703, and 704. The concrete shall be CLASS 5000, with "WATER-REDUCER ADMIXTURE", installed in ONE MONOLITHIC POUR, with VIBRATION.

1.2.4.2 Reinforcing Steel

Steel reinforcement shall conform to the requirements of DOT STANDARD SPECIFICATIONS, Section 703.2.1, which is amended to include the following:

"All references to AASHTO M 31 or ASTM A 615 are hereby deleted and replaced by ASTM A 706 with a single minimum yield strength level of 60,000 psi, designated as Grade 60."

The bars shall be of the size and type shown on the Design Details or in the Standards.

1.2.4.3 Conduit Elbow

Conduit Elbows shall be in accordance with FURNISH AND INSTALL ELECTRICAL CONDUIT. Conduit Elbows in pole bases shall be PVC, of the size and type shown on the Plans. As a minimum, THERE SHALL BE AT LEAST 1 CONDUIT ELBOW (2 INCH PVC ELBOW) IN EACH POLE BASE.

1.2.4.4 Ground Rod

Ground rods shall be 5/8 inch by 8 feet (minimum) Copper-Clad. A No. 6 AWG bare, stranded copper wire shall be used in the ground connection. EACH STRAIN POLE SHALL HAVE 1 GROUND ROD.

1.2.4.5 Pole Plugs

Plugs/Caps, either galvanized or stainless, shall be installed in all un-used holes in steel pole.

1.2.4.6 Miscellaneous

All other hardware or components shall be made of a non-corrosive material, or be of the same material as the item being installed.

1.2.5 **Galvanizing**

The following shall be hot-dipped galvanized to ASTM A-123:

Shaft, Anchor Base, nuts, and hand hole frame and cover, the top 12" of the Anchor Bolts, Pole Clamp, and all other steel or iron parts.

1.2.6 **Powder Coating Over Base (Optional)**

Powder Coating over base shall be an option. The finish color shall be specified at the time of ordering. The following shall be powder coated: Shaft, anchor base, nuts, hand hole frame and cover, the top 12" of the anchor bolts, pole clamp, and all other steel or iron parts.

1.2.7 **Powder Coating Over Galvanized (Optional)**

Powder Coating over galvanized shall be an option. The finish color shall be specified at the time of ordering. The following shall be powder coated after they have been hot-dipped galvanized: Shaft, anchor base, nuts, hand hole frame and cover, the top 12" of the anchor bolts, pole clamp, and all other steel or iron parts.

1.2.8 Pole Labeling

Every Pole shall be easily read and prominently labeled on the outside edge of the base plate. The method used shall be that the pole description is inscribed with "WELDING-BEAD", neatly hand-written, in 1-1/2" to 2" high letters. The legend used shall be one of the following:

13" X 26'
13" X 28'
13" X 32'

Note: Codes shall not be acceptable for pole size labeling. The welding bead shall be applied prior to galvanizing.

In addition to the welding bead identification every pole shall have a metal "Builders Plate" (name plate) with raised or stamped letters stating the manufacturer, the date of manufacture, lot number, the length and diameter of the pole and a ID number. The name plate shall be welded to the outside pole wall about 5' above the base at 0 degrees. Color Coding shall be included on each plate to facilitate ease of selection and identification.

1.2.9 Design and Drawings

The Vendor shall furnish pole design details and shop-drawings in sufficient detail for complete evaluation and comparison with these Specifications. Any exceptions to these Specifications must be stated in writing.

1.2.10 Quality Control, Testing, Certification

Where required, materials must be in full compliance with AASHTO and ASTM in effect on the date of advertisement.

Performance Testing - SCDOT reserves the right to receive on demand a test report from an independent laboratory certifying that the equipment furnished meets these specifications, at no costs to the Department. The bidder shall also provide a certification from the manufacturer that all strain poles shall have a guaranteed minimum yield strength, (mill certified), of 55,000 PSI.

Rejection - SCDOT reserves the right to reject an entire shipment of poles covered by this specification and project, if ten percent (10%) or more are found to be defective within a thirty (30 day period following receipt of materials.

1.2.11 Packaging

For Anchor Bolts – To preserve the threads, to help improve stock yard inventory procedures, and to enhance loading/unloading of the shipment, the Anchor Bolts (for either a pole shipment or as spares) shall be packaged and mounted on a pallet with four (4) anchor bolts across and four (4) levels high. Each layer should lay opposite so that the six inch bend protects the threaded end of the next level.

For Pole Hardware – To help improve stock yard inventory procedures, and to make outside storage possible, all anchor bolt hardware and all pole hardware for each pole shall be included in ONE (1) BURLAP BAG. No cardboard boxes shall be permitted. The bag shall contain the nuts, washers, pole cap, pole covers, pole clamps, pole plugs and all associated hardware. The bag shall be placed inside each steel pole.

If necessary, the bag shall be labeled by pole size if smaller clamps are needed for the 26' poles.

1.2.12 Delivery

SCDOT pickup from Vendor or Supply Depot is an option and will be specified at the time of the order.

Shipment for the poles shall be made via open-bed truck to facilitate unloading. Delivery shall be made to the SCDOT Supply Depot, 1418 Shop Road, Columbia, SC or one of seven District Signal Shops. Notice shall be given to the supervisor at the supply depot (803-737-6631) or the District Signal Shop at least two (2) working days in advance, as to the date of shipment, and expected delivery date to the supply depot. Vendor must have lay down yard and means to load poles on site in South Carolina for SCDOT pickup. Vendor to keep eight (8) 28' steel poles and eight (8) 32' steel poles with hardware in stock at all times for rapid use.

SCDOT District 1 Signal Shop 803-737-6974 1408 Shop Rd Columbia, SC 29201	SCDOT District 3 Signal Shop 803-241-1117 13 Saluda Dam Rd Greenville, SC 29611	SCDOT District 5 Signal Shop 803-661-4812 3018 East Palmetto St Florence, SC 29506	SCDOT District 7 Signal Shop 803-395-7188 1768 Charleston Highway Orangeburg, SC 29115
SCDOT District 2 Signal Shop 864-889-8030 510 W. Alexander Avenue Greenwood, SC29646	SCDOT District 4 Signal Shop 803-581-8551 1143 SCDOT Rd Chester, SC 29706	SCDOT District 6 Signal Shop 843-740-1668 6355 Fain Blvd N. Charleston, SC 29406	

1.2.13 Manufacturer/Supplier

Poles must be manufactured within the United States at a facility solely owned by a company incorporated in the United States. Steel used shall comply with current Federal laws limiting foreign steel.

1.2.14 Warranty

The Manufacturer or Contractor shall warrant the poles and all associated hardware to be free from defects in material and workmanship for a period of two (2) years from date of shipment. Any defects within this period shall be repaired or replaced by the Contractor, at total cost to the Manufacturer or Contractor, including labor, parts and transportation.

1.3 Measurement

Furnishing Steel Strain Poles, will be measured by each, of the size(s) specified, anchor bolts, nut covers, pole cap, reinforcing steel, ground rod, ground wire, and all miscellaneous hardware as required.

1.4 Payment

Furnishing Steel Strain Poles, accepted, and measured as above, will be paid for at the contract unit price bid for:

FURNISH 13" X 26' STEEL STRAIN POLE	EA
FURNISH 13" X 26' STEEL STRAIN POLE (POWDER COATED OVER BASE)	EA
FURNISH 13" X 26' STEEL STRAIN POLE (POWDER COATED OVER GALVANIZED)	EA
FURNISH 13" X 28' STEEL STRAIN POLE	EA
FURNISH 13" X 28' STEEL STRAIN POLE (POWDER COATED OVER BASE)	EA

	FURNISH 13" X 28' STEEL STRAIN POLE (POWDER COATED OVER GALVANIZED)	EA
	FURNISH 13" X 32' STEEL STRAIN POLE	EA
	FURNISH 13" X 32' STEEL STRAIN POLE (POWDER COATED OVER BASE)	EA
	FURNISH 13" X 32' STEEL STRAIN POLE (POWDER COATED OVER GALVANIZED)	EA

M688.6 CONCRETE STRAIN POLE

1.1 Description

This specification describes requirements for furnishing pre-stressed Concrete Strain Poles, of the sizes specified. These poles shall be of the type intended for direct embedding, with the hole back filled with concrete.

The following covers the design and fabrication of pre-stressed concrete strain poles, to be used for supporting steel cable suspended traffic signals or supporting lane control signs.

1.2 Materials

1.2.1 General

ALL CONCRETE STRAIN POLES PROVIDED FOR ANY INDIVIDUAL PROJECT SHALL BE FROM THE SAME MANUFACTURER.

Each Concrete Strain Pole assembly shall consist of:

1. A round pre-stressed hollow concrete shaft,
2. A pole cap, and
3. Miscellaneous hardware as specified.

The poles shall meet or exceed the specifications stated in the latest publication of “American Association of State Highway and Transportation Officials” (AASHTO); “Standard Specifications For Structural Supports For Highway Signs, Luminaires And Traffic Signals” and in particular, “Pre-Stressed Concrete Design”. Stress in concrete due to pre-stressing shall be within the limits stated in the AASHTO Standard. Loss of pre-stress shall be calculated using AASHTO methods. Further, the manufacturer shall provide documentation showing the permeability/water-absorption of their product. Other procedures shall be according to the American Concrete Institute (ACI).

Poles shall be designed and constructed so that all wiring and grounding facilities are concealed within the hollow poles. All hand holes, wire inlets/outlets, inserts for pole steps, through bolt holes and the ground wire shall be cast into the pole during the manufacturing process. **NO FACTORY NOR FIELD DRILLING SHALL BE ALLOWED AFTER THE POLES HAVE BEEN STRIPPED FROM THEIR MOLDS.**

Poles shall be designed in accordance with the following requirements, to provide the Mandatory Ultimate Ground Line Moment and with the cable attachment heights stated below. As given, the design shall assume:

OVERALL POLE LENGTH	EMBEDMENT (below ground line)
35 feet	8 feet
40 feet	10 feet
45 feet	11 feet

The *Defined Attachment Height* = Overall Pole Length – Embedment. The design shall assume a worst case strain (pull) of 22,200 Newtons (5000 pounds force) applied at the top of the pole (the design Defined Attachment Height).

Poles shall be designed using the South Carolina Department of Transportation (SCDOT) design method. A worst case application of AASHTO and ACI "Ultimate Strength Design" has been used. M is moment, T is torsion, U is ultimate.

The formula used: $(1.25 * M / \phi M_u) + (1.25 * T / \phi T_u)^2 \leq 1.0$. The contribution of torsion was neglected. A ϕ of 0.90 was used. Substituting gives $M_u > (1.25 / .9) * M$ or $M_u > 1.39 M$. We increased the 1.39 multiplier by 7 percent, to allow for torsion, fatigue and possible accidental vehicle damage.

Design Formula: $M_u > 1.5 M$

1.2.2 Pole Materials

1.2.2.1 Concrete

The concrete mix shall be designed to achieve a minimum twenty-eight (28) day compressive strength (f_c) of 58,650 kPa (8,500 psi) Pounds per square inch. Cement shall conform to the latest requirement of Type I or Type III Portland cement in accordance with ASTM C-150. The maximum size aggregate may be is 19 mm (Millimeter). (3/4 inch) or (¾") of the clear spacing between the main reinforcing steel and the surface of the pole. Any water reducers, retarders or accelerating admixture used shall conform to ASTM C-494. The water used shall be free from foreign materials in amounts harmful to concrete or embedded steel. The compressive strength at release of pre-stress (f_{ci}) shall be 31,050 kPa (4,500 psi).

1.2.2.2 Reinforcing Steel

NO deformed steel reinforcement (ASTM A-615) shall be used in the manufacturing process.

1.2.2.3 Pre-stressing Steel

Pre-stressing steel stranded rope cable, which shall conform to uncoated 12.7 mm (0.5 inch), 7 wire, stress relieved strand (including low relaxation) of 1,201,500 Newtons (270,000 pound strain) grade, ASTM A-416. The minimum number of strands shall be eight (8) strands.

1.2.2.4 Spiral Reinforcement

Steel wire spiral reinforcement shall conform to ASTM A-82 and shall be of minimum diameter 0.150". The pitch of the spiral reinforcement shall be on 2" centers for the first and last 3' of the pole, and 6.5" centers for the remaining portion of the pole. These requirements are more stringent than AASHTO.

1.2.2.5 Hardware

All structural steel shall conform to ASTM A-36 and be hot-dip galvanized per ASTM A-123. Hand hole frames and covers and all inserts shall be zinc alloy AC41A, ASTM B-240. All bolts, nuts, washers and other fasteners shall be stainless steel or be hot-dip galvanized per ASTM A-153.

1.2.3 Manufacturing

All manufacturing tolerances, details of reinforcement and finishes shall be in accordance with the latest specification for pre-stressed concrete poles, as published in the "Journal Of The Pre-Stressed Concrete Institute".

All poles shall be pre-stressed and be manufactured by the centrifugal spinning process using a mold. The purpose of this requirement is to insure a minimum twenty-eight (28) day compressive strength of 8,500 psi, and to provide the densest possible surface finish.

Forms shall be designed to provide a continuous outside taper of 0.180" per foot of length. Forms shall also provide a minimum of 1" of concrete cover over the pre-stressing strands.

Poles shall have a smooth, natural form finish, concrete soft gray in color (no dyes or stains).

Poles shall be round in cross section, with a hollow center and shall be of one piece construction.

All excess concrete shall be removed from inside of pole before delivery.

Poles shall not have any exposed steel at either top or the butt end. Steel strands, both top and butt end, shall be burned back a minimum of 0.75" and the resulting hole shall be completely sealed with epoxy.

Pole bottom ends shall be plugged with 12" of concrete at the butt end, which shall also have a 2" diameter drain hole through that plug.

1.2.4 Pole Features

Contact the Traffic Signal & Systems Engineer at (803) 737-1050 for: "Standard Drawing 675-115-02" for the height and compass orientation of pole features; and "Typical Concrete Pole Orientation" for intended usage.

– Standard Drawing 675-115-02. <http://www.scdot.org/doing/technicalPDFs/standardDrawings/675-000-00.pdf>.

Each pole shall include the features listed below.

1.2.4.1 Pole Cap

Each pole shall be supplied with a pole cap or top, which shall be made of plate aluminum. (Galvanized steel is NOT acceptable.)

1.2.4.2 Wire Support

A wire support consisting of a diametric reinforcing bar shall be cast inside the pole about 6" from the top. This bar can also be used to anchor the pole cap if necessary.

1.2.4.3 Upper Hand hole

A reinforced hand hole frame, complete with flush cover, with a minimum size of 3.5" x 8", shall be cast into pole approximately (1'-2") from the top of pole at 270°. (Orientate counter-clockwise)

1.2.4.4 Couplings

For weather head installation and entrance of the electrical cables, two (2) 2" I.D. conduit couplings shall be cast into the pole at 0° and 90° (orientate counter-clockwise) approximately (1'-2") from the top of pole and one (1) 2" I.D. conduit coupling (2'-10") from the top of the pole at 0°.

1.2.4.5 Through-Holes

Through-holes, for attaching steel span cable using appropriate through-bolt hardware, shall be at 0°, 90°, 180°, and 270°. The upper holes should be approximately (1'-10") from the top of pole and the lower holes should be approximately (2'-4") from the top of the pole. **NO PVC** (Polyvinyl chloride) is required in holes so that each level of span wire through bolt hardware can be used in multiple directions.

1.2.4.6 Grounding

A No. 4 AWG stranded copper ground wire shall be cast into each pole and be attached to the pre-stressed steel by bonding connectors. The embedded ground wire shall be terminated near the top of the pole and at a point near the bottom, approximately 9" below the ground line. Both terminations shall be made to a "copper tank ground" which provides a 0.5" tapped insert on the pole face for grounding attachment to spans wires at the top and to the driven ground rod at the base.

1.2.4.7 Pedestrian Features

For possible pedestrian signal head assembly, each pole shall have four (4) 1" holes for wiring the signals that will be banded onto the pole at a height 10' above the ground line at 0°, 90°, 180°, and 270°.

For possible pedestrian push buttons, each pole shall have four (4) 1" holes for wiring a push button that will be banded onto the pole at a height 3.5 feet above the ground line at 0°, 90°, 180°, and 270°.

1.2.4.8 Pole Labeling

Every pole shall have an embedded "Builders Plate" (name plate) of brass or aluminum with raised or stamped letters stating the manufacturer, the date of manufacture, lot number, the length and diameter of the pole and the ultimate ground line moment capacity. The name plate shall be cast into the outside pole wall about 5' above the ground line.

1.2.4.9 Rouosting Holes

A 1.5" "CANT" hole, completely through the pole and lined with PVC conduit shall be cast into each pole at a height 4' above ground line. The purpose shall be to permit inserting a pry-bar to turn the pole for proper orientation with the intersection.

There shall also be a Pick-Up point hole at the defined distances from the top of the pole found on the "Concrete Pole Openings, Thru-Bolts & Couplings".

1.2.4.10 Lower Hand Hole

The compass location of the hand hole defines the zero (0) degree point. Each pole for traffic signal support shall have a reinforced hand hole frame, complete with flush cover, with a minimum size of 3.5" x 8.5", shall be cast into the pole approximately 1.5 feet above the ground line.

1.2.4.11 Pole Mounted Cabinet

For possible controller cabinet installation, (2) 3" I.D. conduit couplings shall be cast into the pole at 90° and 270° 1.5 feet from the ground line. **(Note: These couplings flank the lower hand hole)**

1.2.4.12 Underground Conduit Entrance

In each signal pole, there shall be cast in two (2) rectangular underground cable entrance openings (conduit entry hole) at 0° and 270° minimum size of 4" x 10", the top of which shall be located 1.5 feet below the ground line.

1.2.4.13 Pull Rope/Wire

The manufacturer shall furnish inside each pole a nylon or polypropylene rope or stainless steel wire so electrical wires may be pulled in installed pole. The rope or wire shall extend from the conduit opening near the base to the top of the pole.

Other Materials

Other materials shall meet the following requirements:

1.2.5.1 Concrete

The concrete used to embed the pole shall conform to the requirements of SCDOT STANDARD SPECIFICATIONS, Section 701, 702, 703, and 704. The concrete shall be Class 3000 and installed in ONE MONOLITHIC POUR, with VIBRATION.

1.2.5.2 Conduit Elbow

Conduit elbows shall be in accordance with furnish and install electrical conduit. Conduit elbows in pole bases shall be PVC of the size and type shown on the plans. If no other conduit is shown as a minimum, there shall be at least one (1) 2 inch PVC conduit elbow placed in each pole base.

1.2.5.3 Ground Rod

Ground rod(s) shall be 16 mm by 2.4 meters (5/8 inch by 8 feet) (minimum) copper clad. A No. 6 AWG bare stranded copper wire shall be used in the ground connection. **EACH STRAIN POLE SHALL HAVE AT LEAST ONE (1) GROUND ROD.**

1.2.5.4 Miscellaneous

All other hardware or components shall be made of a non-corrosive material or be of the same material as the item being installed.

1.2.5.5 Reinforcing Steel

Not usually needed for a concrete pole.

1.2.5 *Design and Drawings*

Prior to being approved for fabrication, the Contractor shall furnish from the manufacturer to the Engineer, complete stress computations, calculations, pole design details and design drawings in sufficient detail for complete evaluation and comparison with these Specifications. These submittals shall indicate the dimensions and shape of all individual structural and electrical features, their relative location on each pole and their relationship with each other. Drawings shall be made as close to scale as possible and with all details large enough to be self-explanatory. Any exceptions to these Specifications must be stated in writing. When computer programs have been used during the design process, the printouts of the programs or a copy thereof shall be provided to the engineer.

1.2.6 Certification

CATALOG CUTS ARE REQUIRED

The Vendor or Manufacturer shall provide documentation stating the permeability and/or water absorption of their concrete pole.

The Vendor shall provide a written certification from the intended manufacturer that all components of strain poles provided under this item have been designed and manufactured in complete accordance with these specifications and the approved design drawings, including the strength of the concrete. The certification letter shall be signed by an officer of the company.

Poles must be manufactured within the United States at a facility solely owned by a company incorporated in the United States. **The manufacturer must have a minimum of ten (10) years' experience in the design and production of centrifugally spun concrete poles shall have a full time registered professional engineer on staff.** Steel used shall comply with current Federal laws limiting foreign steel.

1.2.7 Quality Control, Testing, Certification

Where required, materials must be in full compliance with AASHTO and ASTM in effect on the date of advertisement.

By furnishing poles for SCDOT, the manufacturer implicitly grants the right of entry and inspection of the manufacturing facility to the Engineer (or designated representative) of SCDOT. If requested, each of the component materials involved in the production of these poles must be sampled, tested and approved by the SCDOT Materials Laboratory prior to the start of production. In addition the total production process, including curing, shall be subject to inspection and approval.

SCDOT, at the discretion of the Engineer, may direct that one (or more) randomly chosen poles shall be shipped directly to a testing facility other than the depot. This may be one of the SCDOT Materials Laboratories or an independent testing facility. There, the pole may be tested to destruction. This "test pole" shall be paid for at the contract unit price.

The Vendor shall furnish a Certification from the Manufacturer or Vendor, that the Steel Cable has been tested to meet or exceed the required tensile strength.

1.2.8 Delivery

SCDOT or Contractor pickup from Vendor or Supply Depot is an option and will be specified at the time of the order.

Shipment for the poles shall be made via open-bed truck to facilitate unloading. Delivery may be made to the SCDOT Supply Depot, 1418 Shop Road, Columbia, SC or any location specified in the state of South Carolina. Notice shall be given to the supervisor at the supply depot (803-737-6631) at least two working days in advance, as to the date of shipment, and expected delivery date to the supply depot. **Logistics for direct deliveries to locations other than the Supply Depot will be the responsibility of the vendor.**

Concrete strain poles shall be delivered to a location specified at the time of ordering. Delivery time shall be no later than thirty (30) calendar days. Any material received that does not meet these specifications will be returned at the expense of the vendor or manufacturer.

1.2.9 Manufacturer/Supplier

Poles must be manufactured within the United States at a facility solely owned by a company incorporated in the United States. Steel used shall comply with current Federal laws limiting foreign steel.

1.2.10 Warranty

The Manufacturer or Vendor shall warrant the poles and all associated hardware to be free from defects in material and workmanship for a period of two (2) years from date of shipment. Any defects within this period shall be repaired or replaced by the Manufacturer or Vendor, at total cost to the Manufacturer or Vendor, including labor, parts and transportation.

1.3 Measurement

Furnishing Concrete Strain Poles will be measured by EACH of the length specified. This shall include pole cap and all miscellaneous hardware as required.

1.4 Payment

Furnishing Concrete Strain Poles accepted and measured as above, will be paid for at the contract unit price.

35' CONCRETE PRE-STRESSED POLE ASSEMBLY	EA
40' CONCRETE PRE-STRESSED POLE ASSEMBLY	EA
45' CONCRETE PRE-STRESSED POLE ASSEMBLY	EA
ALUMINUM POLE CAP	EA
HAND HOLE COVERS	EA

M688.7 CONTROLLER AND CABINET ASSEMBLY

Item	Description	Unit	Estimated Quantity
1	Controller Model 2070 Controller	Each	500
2	Cabinet Assembly (larger) Model 332A	Each	350
3	Cabinet Assembly (smaller) Model 336S	Each	100
4	Conflict Monitor Model 2018 ECL-ip	Each	250
5	Conflict Monitor Model 2010 ECL-ip	Each	250
6	Red Enable Board	Each	200
7	Load Switch Model 200 (SSS-87IO)	Each	2500
8	DC Isolator EDI Model 242	Each	350
9	Flash Transfer Relay Model 430	Each	350
10	Loop Detector Amplifier , LCD Enhanced/Intelligent	Each	500
11	Loop Detector Amplifier Model 222	Each	500
12	Surge Protection for Twisted-Pair Communications	Each	75
13	Flasher Load Switch Model 204	Each	110
14	Cabinet Power Supply Model 206L	Each	75
15	Power Strip	Each	150
16	#2 Lock and Key Set	Each	200
17	Aluminum Extender Base for Cabinet Assembly	Each	200
18	Low Voltage Protection	Each	100
19	2070-7A Card	Each	25
20	Conflict Monitor Tester ATSI Model 8000	Each	20
21	Suitcase Tester for 170 and 2070 controllers	Each	20
22	Cabinet Assembly Display Unit	Each	20
23	Evaluation of Equipment for Repair outside Warranty Period	Each	140
24	Repair Equipment outside Warranty Period	Hours	250
25	SCDOT Signal Cabinet Training	Each	15
26	Conflict Monitor Training	Each	15
27	2070 1C CPU Module	Each	250

EQUIPMENT SPECIFICATIONS

SCDOT's current equipment specifications are included. All equipment supplied under this contract shall meet or exceed these specifications. Include with your proposal detailed information on all products to be supplied. Identify any areas where products fail to meet these specifications as well as any features that exceed SCDOT's current specifications.

The following specifications state the minimum acceptable requirements, materials, and workmanship for traffic signal control equipment to be supplied to SCDOT. These are SCDOT specific requirements that extend or modify the California Department of Transportation (CALTRANS) Specification.

Further, equipment shall conform to the applicable requirements of Underwriter's Laboratory Incorporated (UL); the Electronic Industries Association (EIA); the National Electric Code (NEC); the American Society for Testing and Materials (ASTM); the American National Standards Institute (ANSI); and other applicable standards and specifications.

Described below:

- **EQUIPMENT DETAILS**
- **DELIVERY**
- **WARRANTIES AND SERVICE**
- **DOCUMENTATION**
- **EQUIPMENT DETAILS**

Item 1 Controller Model 2070 Controller

This item consists of furnishing Model 2070 Standard, single port, non-switch, RJ45, Ethernet controller. The controller shall also be digital, solid-state, micro-processor based, keyboard (push-button) programmable, and in accordance with the Network Services Security Policy for Network Attached Devices included in this solicitation. Units shall conform to CALTRANS Transportation Electrical Equipment Specifications (TEES), dated July 21, 2008 except as required herein. Provide model 2070 Controllers composed of the unit chassis and at a minimum, the following modules, assemblies, and software:

- Model 2070-4B Power Supply Module, 3Amp
- Model 2070-3B Front Panel Module
- Model 2070 1B CPU Module, single board or Model 2070 1E CPU Module modified for single Ethernet port operation or Model 2070 1C CPU Module modified for single Ethernet port operation
- Model 2070-2A Field I/O Module
- Model 2070-7A Asynchronous Serial Com Module (price as an optional or add on item)
- Controller must be able to accept and operate fully with Apogee firmware version 65 and 76 and shall be able to communicate with central ATMS.NOW software.

Item 2 Cabinet Assembly (larger) Model 332A

A complete operating Cabinet Assembly containing the standard CALTRANS equipment complement with/including: one (1) Conflict Monitor, twelve (12) Load Switches, two (2) DC Isolators, Fourteen (14) Flash Programming Sockets, Seven (7) Flash Transfer Relays, and eight (8) LCD Enhanced Loop Detectors. The 332A Cabinet Assembly shall NOT include a 2070 Controller.

The Model 332A Cabinet Assembly (66" x 24" x 30") shall be as specified in the CALTRANS Specifications. This Cabinet shall incorporate an INPUT TERMINATION PANEL. The Cabinet shall be base mounted. 332A Cabinet Assembly shall be configured for eight (8) vehicle phases, four (4) pedestrian phases and shall include an AUXILIARY MODEL 420 OUTPUT FILE, for six (6) overlap phases. The Auxiliary Output File shall house three (3) Flash Transfer Relays and six (6) Flash Programming Sockets. The Auxiliary Output File shall be wired to ensure that all six (6) phases flash correctly during flashing operation where 18 channels are being used, no dark signals shall be allowed during the flashing operation. See additional requirements for all cabinet assemblies following this detail.

Item 3 Cabinet Assembly (smaller) Model 336S

A complete operating Cabinet Assembly containing the standard CALTRANS equipment complement with/including: one (1) Conflict Monitor, eight (8) Load Switches, two (2) DC Isolators, eight (8) of Flash Programming Sockets, four (4) Flash Transfer Relays, and six (6) LCD Enhanced Loop Detector. The 336S Cabinet Assembly shall NOT include a 2070E Controller.

The Model 336S Cabinet Assembly (46" x 24" x 22") shall be as specified in the CALTRANS Specifications. The Cabinet shall be capable of side-pole mounting, as well as base mounting. See additional requirements for all cabinet assemblies following this detail.

The 336S Cabinet shall NOT have an AUXILIARY OUTPUT FILE. Additionally, Auxiliary Output files will not be added to a 336S Cabinet Assembly, therefore the additional wiring necessary to add an Auxiliary Output file shall not be installed. All assemblies in the 336S Cabinets shall be installed in the upper most position so that free space at the bottom of the cabinet is maximized. See additional requirements for all cabinet assemblies following this detail.

Items 2, 3 Cabinet Assemblies

The equipment to be furnished shall be in accordance with CALTRANS Transportation Electrical Equipment Specifications (TEES), dated July 21, 2008 except as required herein. Further, the equipment shall meet the special SCDOT requirements, as stated in the following Specifications. In case of conflict, SCDOT Specifications shall govern. In addition to meeting the CALTRANS specifications, **Item 2** and **Item 3** shall also meet the following:

Cabinet structure details

- Front and back door switches shall be fully insulated against water intrusion and located on the bottom door hinge.
- Railroad inputs shall be easily accessible for input installations.
- A Fellowes 99111, or equivalent, power strip shall be installed along the wall on the high voltage side of the cabinet and plugged in to a non-GFI switch on the back of the cabinet power supply.
- Nylon card-guides shall be integrated into the cabinet assemblies where all Load Switch, Flasher, Input File and Power Supply Hardware may be installed. The card guide slots shall be of sufficient depth to support pluggable devices when they are not fully inserted into the electrical receptacles, and the installation or removal of pluggable devices shall not require excessive force.
- AC Service terminal blocks shall be a minimum of 6" from base of the rack-supports.
- To prevent accidental, electrical contact between the Cabinet Assembly and Conflict Monitor Unit, the entire side panel within the output file that is directly adjacent to the solder-side of the Conflict Monitor Unit shall be insulated with non-conductive sheeting, including covering screw heads, rivets, etc. This sheeting shall not degrade over time and shall remain attached to the output file throughout the life of the Cabinet Assembly. This sheeting shall be of minimal thickness as to not impede the insertion and/or removal of the Conflict Monitor Unit.
- Four (4) support braces (two (2) installed on each side) for the rack assembly shall be welded, with a continuous seam, directly under the rack assembly uprights.
- A Nylon Sleeved cable shall be hard wired directly to the cabinet on one end, and have a plugin adapter for the conflict monitor on the other end for monitoring the absence of red. The pin assignments of the Nylon Sleeved cable shall be provided with the Cabinet plans. The Nylon Sleeved cable connection for the conflict monitor shall be physically "keyed" to prevent the cable from being plugged in incorrectly. The Nylon Sleeved cable shall be latched to the conflict monitor. The Nylon Sleeved cable shall be attached to the cabinet so it has to be unplugged before the Conflict Monitor can be removed.
- The 206L Power supply in all Cabinet Assemblies shall be provided with a device that would prevent the power supply from being removed unintentionally. This device must be strong enough to support the weight of the power supply and shall be accessible from the FRONT of the Cabinet Assembly. The insertion or removal of the 206L Power Supply and security device shall not require the use of any tool. The shipping wing nut must be removed.

Internal Cabinet Requirements

- Furnish two (2) sets of non-fading cabinet diagrams and schematics that are to be placed in a clear, sealable, water tight, plastic bag and stored within the front-door-mounted laptop shelf/storage compartment. See "Laptop Shelf" requirements later in this specification.
- Furnish two (2) Model 242 DC Isolators with all 332A and 336S Cabinet assemblies. These items are to be installed within the cabinet input file, in the pedestrian input slots.
- Furnish eight (8) Enhanced LCD Loop Detectors with all 332A Cabinet Assemblies. These are to be installed in the first eight (8) slots of the upper input file assembly. See LCD Detector requirements later in this specification.
- Furnish six (6) Enhanced LCD Loop Detectors with all 336S Cabinet Assemblies. These are to be installed in the first four (4) slots of the input file assembly. See LCD Detector requirements later in this specification.
- Furnish twelve (12) PDC 200 (SSS-87IO), or equivalent, Load Switches with all 332A Cabinet Assemblies. These are to be installed in the following output file channels: 1, 2, 4, 5, 6, 8, 13, 14, 15, 16, 17, and 18. See for Load Switch requirements later in this specification. All load switch locations in the Output file and Auxiliary output file shall be clearly labeled with permanent screening, with the default CALTRANS phase assignment, in all 332A Cabinet Assemblies.
- All terminations to output files shall be soldered to the back side of the panels.

- Furnish eight (8) PDC Model 200(SSS-87IO), or equivalent Load Switches with all 336S Cabinet Assemblies. These are to be installed in the following output file channels: 2, 4, 6, 8, 13, 14, 15, and 16. See Load Switch requirements later in this specification. All load switch locations in the Output file shall be clearly labeled with permanent screening, with the default CALTRANS phase assignment, in all 336S Cabinet Assemblies.
- Furnish two (2) Model 204 Flasher Load Switches with all 332A and 336S Cabinet Assemblies. These are to be installed in the flasher slots within the Power Distribution Assembly (PDA). See Flasher requirements later in this specification.
- Load Switches and Flashers are to be secured within their respective slots for shipment, with 1/2" string-reinforced tape as a minimum.
- Furnish a Thermostat-controlled, dual-fan (100CFM minimum rating per fan) ventilation system in all 332 series Cabinet Assemblies.
- Furnish a Thermostat-controlled, single-fan (100CFM minimum rating) ventilation system in all 336S Cabinet Assemblies.
- 332A and 336S Cabinet Assemblies shall NOT utilize a Mercury Contactor switch. A field-proven solid-state device or equivalent shall be used.
- The Flash Sense/Stop Time terminations in the Input File Assembly shall be wired such that a DC Isolator will not be required for implementation of these functions by the Conflict Monitor Unit.

Power Supply

- The Power Supply furnished in all 332A and 336S Cabinet Assemblies shall be the EDI 206L Switching Power Supply, or equivalent.

Conflict Monitor

- The Conflict Monitor shall be an EDI Model 2018 ECL-IP Conflict Monitor with absence of red monitoring.
- The Conflict Monitor Unit shall contain a 10/100 Ethernet port on the front panel for the uploading of alarms and/or event logs with a standard laptop computer. This port shall also allow for future communication within an Ethernet-based infrastructure.
- The Nylon Sleeved cable shall be routed internally or between the rack assembly and cabinet wall. The cable shall be anchored to the front of the output file so that the Conflict Monitor Unit cannot be removed with the cable attached.

Thermostat

- Cabinet Thermostat to be factory-set to 90 degrees in all Cabinet Assemblies.
- Cabinet Thermostat and thermostat temperature setting shall be easily accessible and adjustable from the front of all 332A Cabinet Assemblies.
- Cabinet Thermostat and thermostat temperature settings shall be easily accessible and adjustable from the rear of all 336S cabinet assemblies.
- Cabinet Thermostat terminals shall be insulated to prevent accidental electric shock.

Pedestrian Button and Loop Detection Inputs

- All Vehicle and Pedestrian terminals on the Loop Input Termination Panel shall be clearly labeled with permanent screening, with the default CALTRANS phase assignment, in all 332A and 336S Cabinet Assemblies.
- "Ped-Yellows" shall be provided with "dummy loads" consisting of load resistors rated at 5 Watts minimum. The impedance of the load resistors shall be such that the Conflict Monitor Unit does NOT see a false indication for the yellow output of the pedestrian channels.
- The 332A Cabinet Assembly shall include additional terminations for Pedestrian Pushbutton inputs. A Minimum of twenty-four (24) extra terminals (12-position, dual-bus terminal strip) shall be provided, allowing sixteen (16) additional termination points for four (4) Pedestrian Phases. The remaining eight (8) termination points shall be for the shared or "common" input for the adjacent Pedestrian Phase terminations. These are to be wired in parallel with the standard input file terminations and surge protection. This termination panel shall be easily accessible, clearly labeled with permanent screening and may be placed in any available space on the side panel containing the standard Loop and Pedestrian

input terminations. The required configuration is shown here:

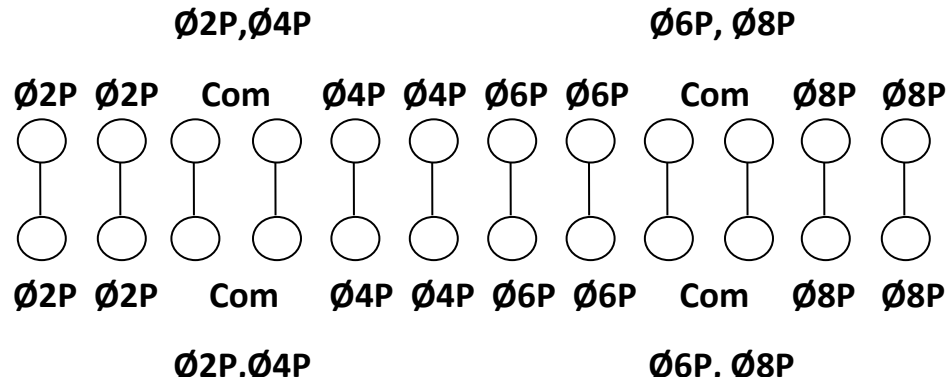

- The 332A and 336S Cabinet Assemblies shall have a ‘Detector Test Panel’ installed above the Controller Unit. The panel shall be installed within the rack assembly and will have eight (8) 3-position mini-toggle switches, symmetrically spaced and horizontally arranged for placing calls to the Controller Unit. 3-position On-Off-On switches shall activate inputs. Upward motion of the switch shall lock into place and shall place a vehicle call to the Controller Unit until the switch is manually returned to center position. The center position of the switch shall not inhibit normal detector operation. Downward motion of the switch shall place a momentary closure vehicle call and will allow the intersection to resume normal detector operation when released. This panel shall be clearly labeled with permanent screening beneath each switch. The labeling shall identify each detector switch and default phase assignment for phases 1 through 8. The panel should also be titled “Vehicle Call Panel” and shall include a legend for switch operation: “On, Auto, Pulse”. The panel shall be wired as follows:

336S Cabinet		332A cabinet	
Detector Switches	Terminal	Detector Switches	Terminal
Phase 1	I1-F	Phase 1	I1-W
Phase 2	I2-F	Phase 2	I4-W
Phase 3	I3-F	Phase 3	I5-W
Phase 4	I4-F	Phase 4	I8-W
Phase 5	I5-F	Phase 5	J1-W
Phase 6	I6-F	Phase 6	J4-W
Phase 7	I7-F	Phase 7	J5-W
Phase 8	I8-F	Phase 8	J8-W

Key Sets and Doors

- Front and rear doors of all cabinet assemblies shall implement a #2 Corbin Locking assembly. Two (2) BRASS keys are to be included with each Cabinet Assembly.
- The front and rear door locks for all Cabinet Assemblies shall have a minimum of 1 mm (0.03937”) clearance between the edge of each side of the lock bolt and the cabinet’s latch cam assembly.
- Both doors shall be ventilated and are to include disposable filters that are secured in place, yet easily removed or re-installed for replacement.
- Front and rear door handles for all cabinet assemblies shall turn away from the door lock/key to open the cabinet door.

Cable

- Appropriate Red, Yellow or Green color-coding shall be used for all Load Switch input and Load Switch output wiring within the Output and Auxiliary Output Files.
- Applicable 170-style cabling shall be included in all 332A and 336 S Cabinet Assemblies.

Police Panel/Button

- Police panel door shall be insulated to prevent water from entering the cabinet assembly. The insulation material used and its ability to resist water-penetration shall not degrade over time.
- The Police panel assembly shall have a drain to prevent water from collecting within the assembly. Per CALTRANS, the drain shall be channeled to the outside of the cabinet. There shall be no additional holes within the police panel.
- The protective cover for the police panel key opening shall be snug with the police panel door and shall not move freely. However, this protective cover shall be easily opened without having to use any tool.
- Manual Control cord shall be permanently hard-wired into the Police panel assembly to prevent removal.
- Manual Cord shall be anchored to the inside of the cabinet chassis to prevent over-extension and/or damage to the Police Panel terminations when the cord is extended for use.
- For storage, the Manual Control cord should be fed into the cabinet assembly through a grommet opening at the top of the police panel. The location of the opening shall not allow water to enter the cabinet. Additionally, the cord shall be fed for storage into an area where there is no risk of ‘snagging’ the cable when it is extended for use. The storage area shall be sealed completely to prevent water from entering the cabinet when the police panel door is open.
- For additional security, a quick-connect/quick-disconnect, molex-style connector shall be used for the Police Panel wiring inside the Cabinet Assembly. This connector shall NOT be accessible from the Police Panel and should be easily accessible from inside the cabinet. The wiring of this connector shall be such that, when disconnected, the Manual Control Enable/Advance Enable function on the Police Panel, as well as the Interval Advance/Advance function on the manual cord cannot be applied to the Controller Unit.
- The Police panel shall be wired such that the Interval Advance/Advance function cannot be applied to the Controller Unit when the Manual/Auto switch is in the Auto position.
- Each 332A and 336S Cabinet Assembly shall be provided with a manual police push button on an insulated cord allowing the operator to stand a minimum of 6’ from the Cabinet Assembly, permanently mounted in conjunction with a manual/auto switch. When placed in the manual position, Manual Control Enable or Advance Enable shall be applied to the Controller, and Minimum Recall shall be applied to all used phases. Activation of the push button shall apply the Interval Advance or Advance input to the Controller Unit. Manual advancement will be prohibited in the minimum green, and clearance timing intervals.

Laptop Shelf

- For all 332, 332A and 336S Cabinet Assemblies, a hinged, aluminum shelf and integrated storage compartment shall be installed on the front door, inside the Cabinet Assembly. The hinge, shelf, or shelf parts shall not come off or interfere with closing the shelf or the cabinet door.
- To allow better ventilation throughout the cabinet and rack, a sliding shelf/drawer within the rack assembly will not be permitted.
- The shelf shall have a smooth, non-slip surface, sufficient for use as a writing platform and of sufficient size and rigidity to support any laptop computer when extended for use.
- This shelf shall have rounded or insulated edges that do not have the potential to physically harm the user.
- The shelf shall lock into place when folded for storage.
- Locking the shelf for storage and/or extending for use shall not require the use of any tool.

Cabinet Lighting

- Each Cabinet shall include two (2) LED lighting fixtures with the switch built-in.
- One mounted inside the top-front portion of the Cabinet and one mounted inside the top-rear portion of the cabinet.
- Both shall illuminate equivocally to a 15-watt, cool white fluorescent light fixture and shall include an easily accessible on-off switch.
- Door-actuated switches shall be installed to turn on the cabinet lights when either the front or rear door are opened.

Mounting

- Each 336S Cabinet shall be supplied with a removable base plate. Two (2) pole mounting brackets shall be attached to each 336S cabinet.
- Install an aluminum plate for reinforcement of the pole-mounting brackets. This plate shall be installed inside the 336S Cabinet Assembly and shall utilize threaded Penn Engineering & Manufacturing Corporation (PEM) nuts or self-clinching fasteners for simple installation and removal of exterior pole-mount bracket bolts without the use of any tool, inside the Cabinet Assembly.
- For 336S and 332A Cabinet Assemblies, the base mounting anchor-bolt pattern shall be as specified in the CALTRANS Specifications.

Surge Protection

- Cabinet assemblies shall include the Emerson (Edco) SHA-1250 Surge Protection device or equivalent, and shall be a plug-in type installation, or shall be integrated onto a plug-in style panel for simple replacement. This assembly should be easily accessible within the Cabinet Assembly shall be mounted a minimum of 6" from base of the rack-supports and secured to prevent unintended removal.
- Removal/replacement of the surge suppressor or manufacturer-designed panel assembly shall not require the connection or disconnection of any wiring within the cabinet and shall be a simple procedure for one (1) technician.
- Each 336S and 332A Cabinet shall be provided with devices to protect the control equipment from surges and over voltages. This shall include incoming power lines, the Input File, the Output File (load switch-packs), and communication lines.
- For any existing on-street twisted-pair communication, an Emerson (Edco) PC642 surge protection device and applicable 170-style cabling shall be included in 332A and 336S Cabinet Assemblies.
- The surge protection for the Input File shall be in accordance with the assignment of the slots of a standard 336S Cabinet assembly. Surge protector termination panels shall be provided, attached to the Cabinet rack assembly. AC isolation terminals shall be on the same side of the Cabinet as the AC service inputs. DC terminals and loop detector terminals shall be installed on the opposite side of the Cabinet from the AC power lines, to reduce electromagnetic induction. The surge protector panels shall be designed to allow for adequate space for a wire connection and surge protector replacement. Surge protection shall be provided for the full capacity of the Cabinet Input File.
- It is the intent of SCDOT to require surge protection on each CALTRANS defined input; that is, full protection. For example, on the 336S Cabinet, Vehicle Loop Detector Surge Protection would be required on two (2) channels each, of Slots 1 to 8 of the Input File. In addition, on the remaining Slots 9 to 14, Pedestrian surge protection; plus Auxiliary (pre-emption) protection as defined.
- On the 332A Cabinet, full protection is desired on both Input Files. For example, Vehicle Loop Detector Surge Protection would be required on two (2) channels each, of Slots 1 to 8 of BOTH INPUT FILES I AND J; together with pedestrian and auxiliary protection on both racks.
- For the 332A Cabinet, appropriate input surge protection shall be mounted on the INPUT TERMINATION PANEL. For the 336S Cabinet, appropriate input surge protection shall be mounted on a FOLD-DOWN TERMINATION PANEL on the rear of the cabinet assembly. This fold-down panel shall not obstruct the Output File Field wiring when in the closed position and shall utilize thumb-screws to secure the panel under normal operating conditions. The fold-down portion of this panel shall be easily accessible and shall be mounted to the rack assembly.
- Under no circumstance (normal operation or short-circuit condition) shall the ampacity of the internal wiring and printed circuit board traces be less than the protecting threshold of circuit breakers and surge protectors provided.

Power Distribution Assembly

- The Power Distribution Assembly of each Controller Cabinet shall include a surge protective device (SPD) on the AC Service Input. It shall be capable of reducing the effect of lightning transient voltages applied to the AC line. The protector shall be a two-stage series/parallel device, and shall be an Emerson (Edco) SHA-1250 or equivalent. The SPD shall meet or exceed the following requirements:
 - Maximum AC line voltage: 140 VAC
 - Twenty pulses of peak current, each of which will rise in 8 μ s and fall in 20 μ s to one-half the peak: 20,000 A

- The protector shall be provided with the following terminals:
 - Main line (AC Line first stage terminal)
 - Main Neutral (AC Neutral input terminals)
 - Equipment Line Out (AC Line second stage output terminal, 10 A).
 - Equipment Neutral Out (Neutral terminal to protected equipment).
 - Ground (Earth connection)
- The Main AC line in and the Equipment Line out terminals shall be separated by a 200 Micro Henry (minimum) inductor rated to handle 10 A AC Service.
- The first stage clamp shall be between Main Line and Ground terminals.
- The second stage clamp shall be between Equipment Line Out and Equipment Neutral.
- The protector for the first and second stage clamp shall have a Metal Oxide Varistor (MOV) or similar solid-state device rated at 20 KA; and be of a completely solid stage design (i.e. no gas discharge tubes allowed).
- The Main Neutral and Equipment Neutral Output shall be connected together internally, and shall have an MOV (or similar solid state device, or gas discharge tubes) rated at 20 KA between Main Neutral and Ground terminals.
- Peak clamp voltage: 250 V at 20 KA. (Voltage measured between Equipment Line Out and Equipment Neutral Out terminals. Current applied between Main Line and Ground Terminals with Ground and Main Neutral terminals externally tied together).
- Output voltage shall never exceed 280 volts.
- The Protector shall be epoxy-encapsulated in a flame retardant material.
- Continuous service current; 10 A at 120 VAC RMS.
- The Equipment Line Out shall provide power to the Controller, and to the 24 V power supply.

Inductive Loop Detector Inputs

- Each inductive loop detector input channel shall be protected by an external, surge protective device which shall be an Emerson (Edco) SRA-6LC-6 or equivalent. The SPD shall meet or exceed the following requirements:
 -
 - It shall be a three-terminal device, two of which shall be connected across the signal inputs of the detector. The third terminal shall be connected to chassis ground to protect against common mode damage.
 - It shall instantly clamp differential mode surges (induced voltage across the loop detector input terminals) via a semiconductor array. The array shall be designed to appear as a very low capacitance to the detector.
 - It shall clamp common mode surges (induced voltage between the loop leads and ground) via solid state clamping devices.
 - It shall meet or exceed the following requirements:

Peak Surge Current:	250A
Differential Mode:	400 A (8x20 μ s)
Common Mode:	1000 A (8x20 μ s)
Estimated Occurrences:	500 @ 200 A
Response Time:	40 ns
Input Capacitance:	35 pf typical
Temperature:	-40 degrees to +85 °C
Mounting:	No. 10-32 x 3/8" bolt
Clamp Voltage:	130VDC
@400 A Differential Mode	30 V maximum
@1000 A Communication Mode	30 V maximum

Signal Load Switches (Switch-Packs)

- The outputs of each switch-pack in the output file shall be provided with a surge protective device comprised of metal oxide varistors (MOVs) which shall be a V150LA20A or equivalent. The SPD shall

meet or exceed the following requirements:

Communication Inputs

- Each low voltage communication input shall be protected as it enters the cabinet with a modular type surge protective device comprised of three-stage hybrid technology protection consisting of gas discharge tubes (GDT), silicon avalanche diodes (SAD) and positive temperature coefficients (PTC), which shall be and Emerson (Edco) PC642C Series or equivalent. The SPD shall meet or exceed the following requirements:
 - US 497B Listed
 - Operating current: 0.15A
 - Peak surge current: 10kA
 - Frequency range: 0 to 20MHz
 - Insertion loss: <0.1 dB at 20 MHz

Low Voltage DC Inputs

- Each DC Input channel shall be protected by an external, surge protective device which shall be an Emerson (Edco) SRA64-030N or equivalent. The SPD shall meet or exceed the following requirements:
 - It shall be a five terminal device. Two terminals shall be connected to the line side of the low voltage pair, two terminals shall be connected to the Input File side, and the fifth terminal shall be connected to chassis ground.
 - It shall meet the following minimum requirements:

Peak Surge Current	2000 A 8x20 μs Wave-shape
Occurrences at Peak Current	100 typical
Response Time	5 to 30 nanoseconds
Shock	Withstands 10-foot drop on concrete
Voltage Clamp	30 V
Series Resistance	5 Ohms typical
Temperature	-40 Degrees to +85 °C

Pre-Emption, Interconnect & 115 VAC Signaling Inputs

Each pre-emption, interconnect, or AC signaling input channel shall be protected by an external surge protective device, which shall be an Emerson (Edco) PC642 Series or equivalent. The Emerson (Edco) PC642 shall use a PCB 1B base for quick changeability.

Items 4-22 are individual replacement parts or optional items. These items must meet the specifications of the equipment to be included in the cabinet or otherwise described. There is no guarantee on the quantity of these items.

Item 4 Conflict Monitor Model 2018 ECL-ip

The Conflict Monitor shall be an EDI Model 2018 ECL-IP Conflict Monitor with absence of red monitoring. The Conflict Monitor Unit shall contain a 10/100 Ethernet port on the front panel for the uploading of alarms and/or event logs with a standard laptop computer. This port shall also allow for future communication within an Ethernet based infrastructure.

Item 5 Conflict Monitor Model 2010 ECL-ip

This is an option for replacement parts only, not to be furnished with the 332A and 336S Cabinet Assemblies for this contract. The Conflict Monitor shall be an EDI Model 2010 ECL-IP Conflict Monitor with absence of red monitoring. The Conflict Monitor Unit shall contain a 10/100 Ethernet port on the front panel for the uploading of alarms and/or event logs with a standard laptop computer. This port shall also allow for future communication within an Ethernet based infrastructure.

Item 6 Red Enable Board

This is an option for replacement parts only, not to be furnished with the 332A and 336S Cabinet

Assemblies for this contract. Red enable board shall implement individual, 2-position Rocker style DIP switches allowing any unused red channel to be tied to AC+. The Red Enable board shall be easily removable and replaceable from the outside of the Output File Assembly. Removal and replacement shall not require the Output File Assembly to be opened. The design shall be such that the board can be easily un-plugged and replaced. During normal operation the board shall be secured to the Output File Assembly.

Item 7 Load Switch Model 200

The Load Switch shall be a PDC MODEL SSS-87PI/O LOAD SWITCH, meeting or exceeding the CALTRANS Specifications.

Item 8 DC Isolator EDI Model 242

The D. C. Isolator unit shall be a EDI MODEL 242 or equivalent as specified in the CALTRANS Specifications.

Item 9 Flash Transfer Relay Model 430

The Flash Transfer Relay unit shall be a MODEL 430 as specified in the CALTRANS Specifications.

Item 10 Loop Detector Rack Mount, LCD Enhanced/Intelligent

The Loop Detector Amplifier Unit shall be an EDI Oracle or Reno A&E Model C Rack Mount Detector Amplifier or equivalent. The Detector shall perform properly when installed in new or existing Cabinet Assemblies in South Carolina.

Item 11 Loop Detector Amplifier Model 222

This is an option for replacement parts only, not to be furnished with the 332A and 336S Cabinet Assemblies for this contract. The Loop Detector Amplifier Unit shall be an EDI MODEL 222, or equivalent, as specified in the CALTRANS Specifications. The detector shall be two (2) channels and shall perform properly when installed in new or existing Cabinet Assemblies in South Carolina.

Item 12 Surge Protection for Twisted-Pair Communications

Surge protection for twisted-pair communication shall be included at SCDOT request when ordering. This device is not standard for all cabinets. The surge protection device shall be an Emerson (Edco) PC642C Series, or equivalent. This shall utilize the PCB1B base.

Item 13 Flasher Load Switch Model 204

The flasher module shall be a PDC MODEL SSF-87P FLASHER, meeting or exceeding the CALTRANS.

Item 14 Cabinet Power Supply Model 206L

The Cabinet Power Supply shall be the EDI Model 206L Power Supply or equivalent. The Power Supply Unit shall incorporate switching design technologies as well as Power Factor Correction.

Item 15 Power Strip

The Power Strip shall be a Fellowes 99111 or equivalent.

Item 16 #2 Lock and Key Set

The #2 Lock and Key Set shall meet the specifications of this contract.

Item 17 Aluminum Extender Base for Cabinet

This item shall be ordered as SCDOT option. For cabinets, an 8" to 12", aluminum extender base shall be available, manufactured in the shape and dimensions that match the shape, dimensions and bolt-pattern of

a Cabinet Assembly. The appropriate stainless steel hardware (nuts, bolts and washers) shall be included with each extender base to sufficiently mount the base to the Cabinet Assembly.

Item 18 Low Voltage Protection

- Each low voltage communication input shall be protected as it enters the cabinet with a surge protection unit which shall be an Emerson (Edco) PC-642C-30-X, or equivalent, that meets or exceeds the following requirements:
 - It shall be a dual pair (four wire) module with a printed circuit board connector, double-sided and gold-plated for reliability.
 - It shall mate and be installed in a ten (10) circuit Buchanan connector PN PCB1B-10A or equivalent.
 - It shall be utilized as two independent signal pairs. The data circuits shall pass through the protection in a serial fashion. It shall be a hybrid two-stage unit.
 - It shall meet the following minimum requirements:

Peak Surge Current	10 KA(8x20 μs, wave shape)
Occurrences at 2000 A	>100
Response Time	<1nanosecond
Voltage Clamp	30
Series Resistance	➤ 15 Ohms per line
Temperature	-40 degrees to +85 degrees C
Primary Protector	Three element gas tube 10KA, 8x20 μs per side
Secondary Protector	Rugged solid state clamps, 1.5 KW minimum

- The line side shall be connected to the Communication field wires.
- The load side shall be connected to the C2 connector of the 170 Controller or the 2070-6B Communication Module of the 2070 Controller.
- The ground terminal shall be connected to chassis ground.

Item 19 2070-7A Card

This is an optional item.

Item 20 Conflict Monitor Tester

The Conflict Monitor Tester shall be the ATSI Model 8000. This shall be a stand-alone portable "Tester", intended for use on a workbench.

Item 21 Suitcase Tester for 2070 controllers

This is an optional item.

Item 22 Cabinet Assembly Display Unit

The unit required for this contract will be used by signal shop technicians during the set up and integration of 336S and 332A Cabinet Assemblies. Via permanent screening, the unit will display a mock-up of a quad intersection with left turns, to include flashing yellow arrow indications for the left turn phases, and shall implement appropriately arranged and colored AC-driven indications of all channels for eight (8) vehicle phases and four (4) pedestrian phases. The unit shall also have additional indications for six (6) auxiliary vehicle overlaps and four (4) pedestrian yellow channels. The display unit shall include a harness that is a minimum of 10' in length, Termination wires shall be red, yellow, and green color-coded and phase marked for all indications, as well as one (1) white, AC Neutral and one (1) green, Chassis Ground termination. All

wires shall have #10 stud spade lugs installed and shall be labeled by phase and color.

The display unit shall provide proper load to accurately simulate on-street, AC signal terminations for testing purposes within a signal shop environment. This unit shall be designed so that it can be placed on top of the Cabinet Assembly, or hung on the inside of the front door of any Cabinet Assembly supplied for this contract.

Item 23	Evaluation of Equipment for Repair outside Warranty Period (Unit is EACH)
----------------	--

SCDOT shall submit equipment to the vendor for evaluation to determine cost to repair. Cost for repair shall be provided to the requestor within seven (7) days of submission.

Item 24	Repair Equipment outside Warranty Period (Unit is HOURS)
----------------	---

SCDOT shall have the option to have equipment repaired based on cost determined through evaluation. Repair shall be completed within thirty (30) days of submission.

Item 25	SCDOT Signal Cabinet Training (Unit is EACH)
----------------	---

SCDOT requires the option of a four (4)-day, formal, "hands-on" classroom-training for traffic signal cabinet assemblies.

The training shall provide a personal "take-home" package of training materials/documentation for each student, as well as a pdf of training materials for SCDOT Headquarters Signals group. Training shall be provided for up to fifteen (15) participants.

The Vendor representing the procurement of Items 1 and 2, Complete Cabinet Assemblies, shall provide training in the design, operation, and maintenance of cabinets and associated equipment; and of cabinet set-up and configuration. The Vendor shall provide all necessary equipment for appropriate demonstration of training. The trainer shall be prepared to present a minimum of eighteen (18) hours of classroom and "hands-on" training.

The Vendor of other, individual items included in this contract shall be prepared to present six (6) hours of classroom and hands-on training for individual bid Items each year. This includes providing appropriate equipment for demonstration and contracting with other vendors as necessary. Details of this training shall be coordinated with SCDOT, and with other Vendors, including subject and materials required.

Sample Training Agenda to include: (Actual training agenda to be at the discretion of SCDOT.)

Day 1: A maximum of fifteen (15) people, would receive "engineering related training", including: Introduction, Equipment description, Operation, and engineer controlled cabinet setup.

Day 2, Day 3: A maximum of fifteen (15) persons would receive "hands-on" training on maintenance and repair of all user serviceable equipment. Maintenance training shall include field level troubleshooting. This training shall be for a minimum duration of two (2) days.

Day 4: The group of fifteen (15) as above shall receive Training on Individual cabinet Items. The subjects shall be coordinated between Vendors, to avoid duplication.

Training classes shall be prepared to start within two (2) months of the receipt of the first shipment of equipment by SCDOT (unless otherwise directed).

Item 26	Conflict Monitor Training (Unit is EACH)
----------------	---

SCDOT requires the option of a one (1)-day training for conflict monitors and testing.

Vendor shall provide training to include Conflict Monitor Testing and programming, including special functions and flashing yellow arrow programming in accordance to SCDOT design guidelines. Vendor shall provide curriculum, three (3) bound copies and a pdf, to SCDOT prior to training. Training shall be provided for up to fifteen (15) participants.

DELIVERY

Direction concerning delivery is for **Items 1-22** is listed below:

- Time

- Vendor to be prepared to provide these items immediately after award. The maximum delivery time permitted will be SIXTY (60) DAYS from the date of the Purchase Order.
- Packaging
 - Equipment shall be appropriately boxed or crated for shipment, to prevent physical damage. The Vendor shall make shipments using the minimum number of containers consistent with the requirements of safe transit, available mode of transportation, and routing. The boxes or crates shall be sealed in 3 mil thick polyethylene plastic sheeting for outdoor storage. Complete Cabinet Assemblies shall be shipped as one unit. Items of equipment packed inside the Cabinet shall be protected and secured for shipment.
- Pallets
 - Cabinet(s) shall be bolted to shipping pallets.
- Labeling
 - Each cabinet/box shall be clearly labeled, IN PLAIN ENGLISH as to the contents; for example: "Type 332A Cabinet". All packages shall be identified with the **Local Vendor Name, Manufacturer Name, SCDOT Purchase Order Number and Shipment Date**. Packing lists and EQUIPMENT LABELS shall be glued to every carton showing its contents. A "Certificate Of Compliance" shall be attached to the packing list of each shipment.
- Schedule
 - The deliveries for **Items 1-22** shall be made to the Supply Depot (1418 Shop Road, Columbia, SC 29201-4844) in Columbia or to the District Signal Shops if requested by SCDOT. When purchased as part of a System the delivery shall be made to a District/location near the Site of work if it is deemed necessary.

SCDOT District 1 Signal Shop 803-737-6974 1408 Shop Rd Columbia, SC 29201-4844	SCDOT District 3 Signal Shop 803-241-1117 13 Saluda Dam Rd Greenville, SC 29611-3818	SCDOT District 5 Signal Shop 803-661-4812 3018 East Palmetto St Florence, SC 29506-	SCDOT District 7 Signal Shop 803-395-7188 1768 Charleston Highway Orangeburg, SC 29115-7722
SCDOT District 2 Signal Shop 864-889-8030 510 W. Alexander Avenue Greenwood, SC 29646-4029	SCDOT District 4 Signal Shop 803-581-8551 1143 SCDOT Rd Chester, SC 29706-6393	SCDOT District 6 Signal Shop 843-740-1668 6355 Fain Blvd N. Charleston, SC 29406-4907	

- Special Orders
 - The Vendor shall follow the shipping instructions as stated on the Purchase Order or attachments.

WARRANTIES, REPAIRS AND SERVICE

- Service - The vendor/manufacturer shall provide services adequate for the operation, repair, and replacement for each item. Adequate service will apply to reasonable response provided by technical personnel experienced with each item.
- Repair Parts – The Vendor shall be able to ship to the Department within three (3) business days, any component parts required to maintain this equipment.
- Maintenance and Repair Services – Complete data on maintenance and repair services shall be available, for the convenience of the Department, in the post-warranty period as listed below.
- This maintenance data shall include location of the service facility, services offered, turn-around time, and estimated repair costs.
- Warranty Period
 - The Vendor shall fully guarantee all items, services, equipment and materials provided under this contract. If the equipment Vendor is other than the Manufacturer, then the Vendor shall be fully responsible for all warranties and requirements of this Specification. The duration of the warranty or guarantee shall be the standard of the industry, with a minimum period of twenty-four (24) months from the date of shipment to the SCDOT. The warranty shall cover all Manufacturer's defects, including parts, labor, and shipping costs. Any item found not in

accordance with this Specification will be rejected, and returned to Vendor at the Vendor's expense for immediate replacement. A second occurrence of this infraction will be sufficient reason for total rejection of the contract for that item.

- Repair
 - The vendor shall have an office and/or authorized factory representative within 150 miles of Columbia, SC and be able to perform on-site warranty repair or replacement of items purchased from this contract, within two (2) business days after receiving complaint. The authorized factory representative shall have a permanent office located within the state of South Carolina. This office shall have a permanent street address, Air Conditioning and Heat, a permanent indoor restroom, a listed voice number, and computer/internet access with a valid e-mail address. Warranty repairs are to be performed at no additional cost.
- Extension
 - Following warranty repair or replacement, the warranty period (for that item or module), shall be extended for an additional period of one (1) year.
- Required Equipment Submittals:
 - One each of the exact cabinets, FULLY OPERATIONAL WITH REQUIRED EQUIPMENT, WIRING, LABELING, ETC., the Vendor intends to supply, INCLUDING PACKAGING, (one 336S and one 332A) for inspection before the contract is awarded.

DOCUMENTATION – (This Section supersedes the CALTRANS Specification.)

- Cabinet Assemblies
 - The Vendor of COMPLETE CABINET ASSEMBLIES shall be responsible for providing with each and every Complete Assembly Cabinet, two (2) complete Cabinet Wiring Diagrams
- Other Equipment
 - Documentation is also required for each auxiliary piece of equipment in the Cabinet Assembly. The intent is to require documentation sufficient for operation and maintenance of each item to the satisfaction of SCDOT. All documentation shall be prepared in a clear, concise manner; with appropriate illustrations, tables, and cut-away drawings, and voltage/waveform reference pictures.
- Binding
 - The documentation shall be adequately BOUND, for protection and to prevent loss of pages. Binding should consist of two heavy-duty staples, with binding tape; or plastic spiral binding. Fonts and sizes shall be per CALTRANS Specifications.
- Contents
 - The vendor shall provide ten (10) sets of documentation material as described below at the request of SCDOT.
 - The documentation material shall include, but not be limited to, the following:
 - General description.
 - Installation procedure.
 - Operating procedure.
 - Theory of operation, voltages, wave forms.
 - Maintenance and troubleshooting procedures.
 - Schematic diagrams of circuits and IC boards.
 - Pictorial layout of IC board components.
 - Parts list including description, reference symbol, part number and location.

M688.9 SOLAR POWERED FLASHER ASSEMBLY

1.1 Description

This specification describes requirements for furnishing a Solar Powered Flasher Assembly.

1.2 Materials

1.2.1 24/7 Single Solar 24 Hour Flashing Beacon

1.2.1.1 Overview

This specification is for the Single Beacon Solar 24 Hour Flashing Beacon. Each unit shall consist of a solar engine, LED signal module and signal housing, and mounting hardware. The system shall conform to all provisions of the MUTCD, Chapter 4K, and Flashing Beacons.

1.2.1.2 Mechanical Specifications

The solar engine shall be vented to provide cooling of the battery and electronic system. Venting shall be covered by wire mesh to prevent intrusion of insects. The unit shall have the provision to mount a external device for remote activation. System must have capability to power such device.

1.2.1.3 Solar / Battery System

The solar engine shall have a field replaceable sealed lead acid battery or batteries. Solar panel and battery system shall be 12 Volt DC.

The solar panel or panels shall meet the design qualification and type approval of photovoltaic modules in accordance with IEC 61215. This specification includes radiation testing, thermal testing, and mechanical testing for environmental conditions such as UV-exposure, thermal cycling, as well as degradation of maximum power output.

Battery shall be mechanically secured into the housing. System shall have an auxiliary 12 VDC power output to power third party devices such as wireless radios or sensing equipment.

1.2.1.4 Signal Housing

The signal housing shall meet the equipment standard of the Institute of Transportation Engineers (ITE) Vehicle Traffic Control Signal Heads (VTCSH) Chapter 2.

1.2.1.5 LED Signal Module

The LED signal module shall conform to the mandatory specifications of: Light Emitting Diode (LED) Circular Signal Supplement as required by the Manual of Uniform Traffic Control Devices 2003 Edition Revision 1.

1.2.1.6 Operational Specifications

The system shall conform to all standards for flashing beacons as required in the Manual of Uniform Traffic Control Devices 2003 Edition Revision 1 or current version.

- The beacon shall flash at a rate set by MUTCD.
- The beacon shall have a minimum operating autonomy of 30 days.
- The beacon shall automatically reduce light output in case of low battery situations, reducing risk that the beacons will fail entirely under conditions of poor solar insolation.

1.2.1.7 Activation

The beacon shall operate continuously when the battery is connected. The beacon shall have the option to be turned on by a third party switch or third party device with a compatible contact closure output.

1.2.2 **24/7 Single Compact Solar 24 Hour Flashing Beacon**

1.2.2.1 Overview

This specification is for the Single Beacon Compact Solar 24 Hour Flashing Beacon.

Each unit shall consist of a self-contained solar engine, LED signal module and signal housing, and mounting hardware such that the entire assembly mounts to the top of the pole. The solar engine shall contain all electronics, batteries & solar panels. No additional cabinet is required. The system shall conform to all provisions of the MUTCD, Chapter 4K, and Flashing Beacons. See Diagrams 1a and 1b.

Diagram 1a.
Single Beacon
Compact – Pole
Mount
(Square/Round)



Diagram 1b.
Single Beacon
Compact – Top of
Pole Mount
(4 1/2" Round)



1.2.2.2 Mechanical Specifications

The Solar panel shall be mounted to the solar engine. All batteries and electronics shall be mounted in the solar engine, with no external control cabinet or battery cabinet required. The solar engine shall be vented to provide cooling of the battery and electronic system. Venting shall be covered by wire mesh to prevent intrusion of insects.

The solar engine shall have the provision to mount an external device for remote activation. System must have capability to power such device. Solar engine must contain sufficient space to house third party device inside a sealed enclosure located inside the solar engine.

The entire system must be delivered as a complete unit ready to install and requiring no assembly.

1.2.2.3 Solar / Battery System

The solar engine shall include a minimum 10-watt solar panel. The solar engine shall house a field replaceable sealed lead acid battery or batteries. Solar panel and battery system shall be 12 Volt DC.

The solar panel shall meet the design qualification and type approval of photovoltaic modules in accordance with IEC 61215. This specification includes radiation testing, thermal testing, and mechanical testing for environmental conditions such as UV-exposure, thermal cycling, as well as degradation of maximum power output.

The solar panel shall consist of a solar panel or panels, mounted to the solar engine.

Battery or batteries shall be mechanically secured into the housing. Battery bracket shall enclose the battery in a manner to restrict the thermal expansion of the battery.

System shall have an auxiliary 12 VDC power output to power third party devices such as wireless radios or sensing equipment.

1.2.2.4 Signal Housing

The signal housing shall meet the equipment standard of the Institute of Transportation Engineers (ITE) Vehicle Traffic Control Signal Heads (VTCSH) Chapter 2.

The signal head shall be mounted below the solar engine.

1.2.2.5 LED Signal Module

The LED signal module shall conform to the mandatory specifications of: Light Emitting Diode (LED) Circular Signal Supplement as required by the Manual of Uniform Traffic Control Devices 2003 Edition Revision 1.

1.2.2.6 Operational Specifications

The system shall conform to all standards for flashing beacons as required in the Manual of Uniform Traffic Control Devices 2003 Edition Revision 1 or current version.

- The beacon shall be flash at a rate of set by MUTCD.
- The beacon shall have a night dimming feature.
- The beacon shall have a minimum operating autonomy of 30 days.
- The beacon shall automatically reduce light output in case of low battery situations, reducing risk that the beacons will fail entirely under conditions of poor solar insolation.

1.2.2.7 Activation

The beacon shall operate continuously when the battery is connected. The beacon shall have the option to be turned on by a third party switch or third party device with a compatible contact closure output.

1.2.3 *Dual 24 Hour Solar Powered Flashing Beacon*

1.2.3.1 Overview

This specification is for the solar powered 24 hour flashing beacon. Each unit shall consist of a self-contained solar engine, two LED signal modules and signal housings, and mounting hardware to fit the

installation. The solar engine shall connect to two 12" yellow or red LED lens. The solar engine, mounting hardware, and signal heads shall be available in black, yellow, and green. See Diagrams 2.

Diagram 2.
Dual Beacon
Compact – Top of
Pole Mount
(4 1/2" Round)

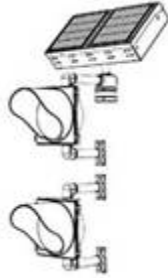

1.2.3.2 Mechanical Specifications

The weight of the solar engine shall not exceed 52 pounds. The solar engine must be able to rotate 360 degrees and tilt for maximum solar energy collection. Batteries shall be field replaceable.

1.2.3.3 Signal Housing

The signal housings shall be constructed of polycarbonate material, and must be adjustable independent from the bracket for lens alignment. The signal housings shall meet the equipment standard of the Institute of Transportation Engineers Vehicle Traffic Control Signal Heads (VTCSH) Chapter 2. The lenses shall be ITE compliant 12" yellow LED lenses.

1.2.3.4 Standards

The system shall conform to all standards for flashing beacons as required in the Manual of Uniform Traffic Control Devices 2003 Edition Revision 1 or current version. These include complying with the VTCSH specifications.

- The flash rate shall be MUTCD compliant.
- The beacons shall have a night dimming feature.
- The beacons shall have a minimum operating autonomy of 30 days
- The beacons shall automatically reduce light output in case of low battery situations, reducing risk that the beacons will fail entirely under conditions of poor solar insolation.

1.2.4 *Dual Solar Powered School Flashing Beacon*

1.2.4.1 Overview

This specification is for the solar powered school flashing beacon. Each unit shall consist of a solar engine, two LED signal modules and signal housings, and mounting hardware with timing device. The system shall conform to all provisions of the MUTCD, Chapter 4K, and Flashing Beacons.

1.2.4.2 Mechanical Specifications

The solar engine shall be vented to provide cooling of the battery and electronic system. Venting shall be covered by wire mesh to prevent intrusion of insects. The solar engine shall have the provision to

mount an external device for remote activation. System must have capability to power such device. Unit must provide a cabinet or contain sufficient space to house third party device inside a sealed enclosure.

1.2.4.3 Solar / Battery System

The solar engine shall have a field replaceable sealed lead acid battery or batteries. Solar panel or panels and battery system shall be 12 Volt DC.

The solar panel or panels shall meet the design qualification and type approval of photovoltaic modules in accordance with IEC 61215. This specification includes radiation testing, thermal testing, and mechanical testing for environmental conditions such as UV-exposure, thermal cycling, as well as degradation of maximum power output.

Battery or Batteries shall be mechanically secured into the housing.

System shall have an auxiliary 12 VDC power output to power third party devices such as wireless radios or sensing equipment.

1.2.4.4 Signal Housing

The signal housings shall meet the equipment standard of the Institute of Transportation Engineers Vehicle Traffic Control Signal Heads (VTCSH) Chapter 2.

1.2.4.5 LED Signal Module

The LED signal module shall conform to the mandatory specifications of: Light Emitting Diode (LED) Circular Signal Supplement as required by the Manual of Uniform Traffic Control Devices 2003 Edition Revision 1.

1.2.4.6 Standards

The system shall conform to all standards for flashing beacons as required in the Manual of Uniform Traffic Control Devices 2003 Edition Revision 1 or current version.

- The flash rate shall be MUTCD compliant.
- The beacons shall have a minimum operating autonomy of 30 days
- The beacons shall automatically reduce light output in case of low battery situations, reducing risk that the beacons will fail entirely under conditions of poor solar insolation.

1.2.4.7 Activation

The beacon shall operate continuously when the battery is connected. The beacon shall have the option to be turned on by a third party switch or third party device with a compatible contact closure output. A timer shall be included in this as an option.

1.2.5 *Dual Compact Solar School Zone Flasher*

1.2.5.1 Overview

This specification is for the Dual Compact Solar School Zone Flasher.

Each unit shall consist of a self-contained solar engine, two LED signal modules and signal housings, and mounting hardware such that the entire assembly with the exception of the bottom LED mounts to the top of the pole. The solar engine shall contain all electronics, batteries & solar panels. No additional cabinet is required. The system shall conform to all provisions of the MUTCD, Chapter 4K, and Flashing Beacons. See Diagram 3.

Diagram 3
Dual Beacon
Compact School
Zone Flasher

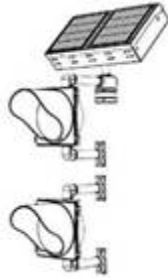

1.2.5.2 Mechanical Specifications

The Solar panel shall be mounted to the solar engine. All batteries and electronics shall be mounted in the solar engine, with no external control cabinet or battery cabinet required. The solar engine shall be vented to provide cooling of the battery or batteries and electronic system. Venting shall be covered by wire mesh to prevent intrusion of insects.

The solar engine shall have the provision to mount an external device for remote activation. System must have capability to power such device. Solar engine must contain sufficient space to house third party device inside a sealed enclosure located inside the solar engine.

The overall weight of the assembly, including mounting hardware, signal housing, LED module, and solar engine shall not exceed 55 lbs.

1.2.5.3 Solar / Battery System

The solar engine shall include a minimum 10-watt solar panel. The solar engine shall house a replaceable sealed lead acid battery or batteries. Solar panel and battery system shall be 12 Volt DC.

The solar panel shall meet the design qualification and type approval of photovoltaic modules in accordance with IEC 61215. This specification includes radiation testing, thermal testing, and mechanical testing for environmental conditions such as UV-exposure, thermal cycling, as well as degradation of maximum power output.

The solar panel shall consist of one single solar panel, mounted to the solar engine.

Battery shall be mechanically secured into the housing. Battery bracket shall enclose the battery in a manner to restrict the thermal expansion of the battery.

System shall have an auxiliary 12 VDC power output to power third party devices such as wireless radios or sensing equipment.

1.2.5.4 Signal Housing

The signal housing shall meet the equipment standard of the Institute of Transportation Engineers (ITE) Vehicle Traffic Control Signal Heads (VTCSH) Chapter 2.

The signal head shall be easily removable from the assembly. The signal housing must be adjustable independent from the bracket for lens alignment.

1.2.5.5 LED Signal Module

The LED signal module shall conform to the mandatory specifications of: Light Emitting Diode (LED) Circular Signal Supplement as required by the Manual of Uniform Traffic Control Devices 2003 Edition Revision 1.

1.2.5.6 Operational Specifications

The system shall conform to all standards for flashing beacons as required in the Manual of Uniform Traffic Control Devices 2003 Edition Revision 1 or current version.

The beacon shall be flash at a rate set by MUTCD. The illuminated period of each flash shall not be less than one-half and not more than two-thirds of the total cycle.

- The beacon shall have a night dimming feature.
- The beacon shall have a minimum operating autonomy of 30 days.
- The beacon shall automatically reduce light output in case of low battery situations, reducing risk that the beacons will fail entirely under conditions of poor solar insolation.

1.2.6 Warranty

The Vendor shall furnish SCDOT with any warranties on equipment and materials that are provided by the Manufacturer or Vendor as normal trade practice.

1.3 Measurement

Furnishing a Solar Powered Flasher Assembly shall be measured by EACH and shall include all electrical connections and all required mounting and incidental hardware.

1.4 Payment

Furnishing a Solar Powered Flasher Assembly, accepted and measured as provided above, will be paid at the contract unit price bid for:

FURNISH SINGLE BEACON/COMPACT/MODEL R247C (INCLUDES ALL ASSOCIATED HARWARE FOR A COMPLETE AND OPERATIONAL ASSEMBLY)	EA
FURNISH SINGLE BEACON/STANDARD/MODEL R247 (INCLUDES ALL ASSOCIATED HARWARE FOR A COMPLETE AND OPERATIONAL ASSEMBLY)	EA
FURNISH DUAL BEACON COMPACT/MODEL R247 DUAL (INCLUDES ALL ASSOCIATED HARWARE FOR A COMPLETE AND OPERATIONAL ASSEMBLY)	EA
FURNISH DUAL BEACON STANDARD/MODEL R829 (INCLUDES ALL ASSOCIATED HARWARE FOR A COMPLETE AND OPERATIONAL ASSEMBLY)	EA
FURNISH DUAL BEACON COMPACT/MODEL R829C (INCLUDES ALL ASSOCIATED HARWARE FOR A COMPLETE AND OPERATIONAL ASSEMBLY)	EA
FURNISH DUAL BEACON COMPACT/MODEL R829C-D4 (INCLUDES ALL ASSOCIATED HARWARE FOR A COMPLETE AND OPERATIONAL ASSEMBLY)	EA

FURNISH DUAL BEACON COMPACT/MODEL R820C (INCLUDES ALL ASSOCIATED HARWARE FOR A COMPLETE AND OPERATIONAL ASSEMBLY)	EA
FURNISH DUAL BEACON STANDARD/MODEL R820 (INCLUDES ALL ASSOCIATED HARWARE FOR A COMPLETE AND OPERATIONAL ASSEMBLY)	EA
FURNISH TIME CLOCK/CONNECTOR/MODELAP22-503544	EA
FURNISH TIME CLOCK SO'WARE KIT/MODELAP22-KIT	EA
FURNISH 12" YELLOW LED/MODEL 47553	EA
FURNISH 12" RED LED/MODEL 48820	EA
FURNISH 1 SECTION SIGNAL HEAD/MODEL CAMSIG	EA
FURNISH SOLAR FLASHER SCHOOL ZONE SOFTWARE/CPK	EA
FURNISH EMERGENCY MANAGEMENT SYSTEM/MODEL 46319	EA
FURNISH 12V DC SEALED BATTERY/MODEL 37912	EA
FURNISH LED HARNESS 15'/MODEL 48901	EA
FURNISH LED HARNESS 36 './MODEL 48902	EA
FURNISH LED HARNESS 75 './MODEL 56928	EA
FURNISH FIXED WEDGE TOP PLATE/BASE ASSEMBLY/WEDGE	EA
FURNISH COMMUNICATION CABLE/SZ FLASHER/MODEL COMSCH	EA
FURNISH UPLOAD HOUSING KIT/MODEL 48941	EA
FURNISH HOUSING BOX FOR TIME SWITCH/MODEL 47256	EA
FURNISH MANUAL ON/OFF SWITCH HARNESS/MODEL47223	EA
FURNISH TOP PLATE WEDGE/MODEL 50571	EA
FURNISH 2" SQUARE POLE MOUNT(C BRACKET)/MODEL47362	EA
FURNISH SLIP FILLER, 1&2 WAY/MODEL SE-3302-P29	EA
FURNISH SIDE-OF-POLE ASSEMBLY/MODEL SP-5641-P29	EA
FURNISH SIDE POLE W/HUB PLATE/MODEL SP-5641-P29	EA
FURNISH 1-WAY TRI-STUD MOUNTING/MODEL SE-0567-P29	EA
FURNISH UPPER/LOWER ARM ASSEMBLY/MODEL SE-3148-P29	EA
FURNISH 1 WAY ASTRO-BRAC ASSEMBLY/MODEL AB-0125-96	EA
FURNISH SPAN WIRE HANGAR/MODEL SP-1004SC-P29	EA
FURNISH HORIZONTAL MOUNT SOLAR ENGINE SUPPORT ARM/MODEL 46560	EA
FURNISH PIPE ADAPTOR FOR WEDGE/MODEL 47504	EA
FURNISH 8' 4 1/2" ALUMINUM PED POLE/MODEL PB-5100-8	EA
FURNISH 10' 4 1/2" PED POLE/MODEL PB-5100-10	EA
FURNISH 12' 4 1/2" PED POLE/MODEL PB-5100-12	EA
FURNISH 15' 4 1/2" PED POLE/MODEL PB-5100-15	EA
FURNISH DOUBLE PUSH BUTTON STATION/MODEL SE-6042	EA
FURNISH ALUMINUM SQUARE PED BASE /MODEL PB-5335-1S	EA
FURNISH PED BASE COLLAR/MODEL PB-5325	EA
FURNISH 2" SQUARE POST MOUNT SINGLE W/SIGNAL/LED/2SQ	EA
FURNISH SOLAR ENG 10W/MODEL R247ENGINE ONLY 10	EA
FURNISH SOLAR ENG 20W/MODEL R247ENGINE ONLY 20	EA
FURNISH SOLAR ENG 10W/SCHOOL/R829ENGINE ONLY10	EA

FURNISH SQUARE WOOD POST MOUNT W/WEDGE/MODEL SWP	EA
FURNISH TOP POLE MOUNT W/WEDGE/MODEL 45RS	EA
FURNISH TOP POLE MOUNT W/WEDGE/MODEL 45RDV	EA
FURNISH TOP POLE MOUNT W/WEDGE DUAL HORIZONTAL/45RDH	EA
FURNISH SIDE POLE MOUNT W/WEDGE/MODELSPS	EA
FURNISH SIDE POLE MOUNT W/WEDGE/DUAL/MODEL SPD	EA
FURNISH MAST ARM MOUNT W/WEDGE/SINGLE/MODEL MAMS	EA
FURNISH MAST ARM MOUNT W/WEDGE/DUAL/MODEL MAMD	EA
FURNISH CPR/AP22 COMMUNICATION CENTRAL/MODEL 501638R	EA
FURNISH CPR2102 UPDATE/MODEL 500900	EA
FURNISH CPR2102 TIME CLOCK/MODEL 503602-D	EA
FURNISH CPR2102 VERIFY UNIT/MODEL 503600-D	EA
FURNISH MASTER RADIO UNIT/POWER SUPPLY/MODEL 503646	EA
FURNISH CPR INTERNAL RADIO/MODEL 503645	EA
FURNISH CPR EXTERNAL RADIO/MODEL 503645E	EA
FURNISH CPR SOLAR REPEATER STATION/MODEL 503649F	EA
FURNISH CPR AC REPEATER STATION/MODEL 503649FAC	EA
FURNISH CPR RADIO REPEATER W/PS/MODEL 503647	EA
FURNISH CPR PROGRAMMING KIT/MODEL 501662NB	EA
FURNISH 10db YAGI ANTENNA/MODEL 503525Y	EA
FURNISH 6db OMNI ANTENNA/MODEL 503525OMNI	EA
FURNISH 11db OMNI ANTENNA/MODEL 505472-11db	EA
FURNISH DISC ANTENNA/MODEL 503544	EA
FURNISH TABLE TOP ANTENNA/MODEL 503501M	EA
FURNISH 25 ' ANTENNA LEAD/CPR RADIO/505472L-25	EA
FURNISH 50 ' ANTENNA LEAD/CPR RADIO/505472L-50	EA
FURNISH 100' ANTENNA LEAD/CPR RADIO/505472L-100	EA
FURNISH 150' ANTENNA LEAD/CPR RADIO/505472L-150	EA
FURNISH CPR RADIO/TIME SWITCH CONVERTER/503648C	EA
FURNISH CPR 2101 TIME SWITCH/503645W	EA
FURNISH 3db WI-FI ANTENNA W/3' LEAD/504413WF	EA
FURNISH WI-FI to TIME SWITCH CONVERTER/503485	EA
FURNISH WI-FI TRANSCEIVER/MODEL 501680	EA
FURNISH ANTENNA BRACKET/MODEL 502356	EA
FURNISH CPR DISPLAY TERMINAL/MODEL 502620	EA
FURNISH CPR AUDIO VISUAL ALARM/MODEL 503626	EA

689.1 BATTERY BACK-UP SYSTEM

1.0 DESCRIPTION

1.1 General

This specification establishes the minimum requirements for a complete emergency battery back-up system for use at traffic signals utilizing Light Emitting Diode (LED) signal heads; blank out no turn signs, and pedestrian signal heads. The BBS shall provide emergency power to a traffic signal in the event of a power failure or interruption.

The Battery Back-up System (BBS) shall include, but not be limited to the following:

- Cabinet with Generator Door and Outlet
- Automatic/Manual Transfer Switch
- Generator Transfer Switch
- Batteries
- Inverter/Charger
- Mounting hardware
- Wiring
- Remote Battery Monitoring System

1.2 Operation

1.2.1 General

The BBS shall provide the following operational modes when operating on battery power: full operation of all traffic signal devices, flash operation and a combination of full and flash operation.

1.2.2 Run Time

The BBS shall be programmed to provide a minimum of 400 W for 8.0 hours of full time operation for a traffic signal utilizing LED only vehicle and pedestrian indications. The minimum battery size requirement is listed in section 6.1, Battery Type.

1.2.3 Compatibility

The BBS shall be compatible with all existing SCDOT controller and all cabinet components for full time operation.

1.2.4 Output Capacity

The BBS shall provide a minimum of 1100 W @ 25°C active output capacity with 80% minimum inverter efficiency with 30% loading.

1.2.5 Output Voltage

When operating in backup mode, the BBS output shall be 120 VAC \pm 10 VAC, pure sine wave output: 3% THD, 60 Hz \pm 0.05 Hz. No square or stepped wave shapes are acceptable.

1.2.6 DC System Voltage

The BBS DC System voltage shall be 48 VDC.

1.2.7 Transfer Time

The maximum transfer time allowed from disruption of normal utility line voltage to stabilized inverter line voltage from batteries shall be a maximum of 8 ms. The same maximum allowable time shall also apply when switching from the inverter line voltage to utility-line voltage. Transfers to and from battery operation shall not interfere with the operation of the other equipment in the intersection.

1.2.8 Operating Temperature

The BBS and all components shall operate without performance degradation over a temperature range of -37°C to +74°C. Additionally, all components and parts used shall, at the minimum, be rated for this temperature range.

1.2.9 Feedback Level

In the event the AC service feeding the BBS is severed, or there is a utility blackout, the AC voltage measured at the AC input to the BBS (line to neutral) shall be less than 1 VAC.

1.2.10 Surge Protection

The BBS shall have lightning surge protection compliant with IEEE/ANSI C.62.41 Category A&B.

1.2.11 Power and Control Connections

The BBS shall be easily installed, replaced, or removed by using easily removable cables for AC input, AC output, DC input, external transfer control and battery temperature sensor.

1.2.11.1 AC Connection

The AC input and output shall be panel mounted plug/receptacles or hard-wired connections that allow no possibility of accidental exposure to dangerous voltages. If utilizing plug/receptacles the AC Input shall be a male receptacle and the AC output shall be a female receptacle. The receptacles shall utilize some form of locking mechanism or hold down clamps that prevent accidental disconnects.

1.2.11.2 DC Connection

The DC connection shall be a recessed one- or two-piece Anderson Style receptacle.

1.2.11.3 Relay/Temperature Probe Connections

The battery temperature sensor input shall be panel-mounted Telco style connector.

1.2.12 Unit Failure

In the event of inverter/charger failure, battery failure or complete battery discharge, the power transfer switch shall revert to a Normally Closed (NC) (and de-energized) state, where utility line power is connected to the cabinet.

1.2.13 Overload

The BBS must be able to shut down in order to protect against internal damage in the event of an overload at the output.

1.2.14 AC Feedback

The BBS shall prevent a malfunction feedback to the cabinet or from feeding back to the utility service. In the event of BBS failure (inverter/charger or battery) or complete battery discharge, the power transfer relay shall revert to a NC (and de-energized) state where utility line power is connected to the cabinet.

1.2.15 Automatic Shutdown

The BBS shall initiate an automatic shutdown when battery output reaches 42 VDC.

1.2.16 Destructive Discharge or Overcharge

The BBS shall be equipped with an integral system to prevent the battery from destructive discharge or overcharge.

1.2.17 Power Conditioning

The BBS shall provide power conditioning at all times.

2.0 AUTOMATIC/MANUAL BYPASS SWITCH**2.1 Rating**

The BBS shall include an Automatic/Manual Bypass Switch rated at 120 VAC / 30 A minimum.

2.2 Automatic/Manual Bypass Switch

Placing the Automatic/Manual bypass switch in the "Bypass" mode shall transfer the intersection load from the Uninterruptible Power Supply (UPS) output directly to commercial power. An inverter input circuit breaker shall be provided and located on the Automatic/Manual Bypass Switch to shut off commercial power to the UPS input, allowing safe disconnection and removal of the inverter. With the inverter turned off, the UPS and batteries can be safely disconnected from the system.

2.3 Indicator Light

The Automatic/Manual Bypass Switch shall include a bypass indicator light that automatically notifies the user when the Manual bypass switch is in Bypass position. The indicator light shall be illuminated when in UPS mode and off when in bypass mode.

2.4 Terminal Block

The Automatic/Manual Bypass Switch shall have terminal blocks capable of accepting #6 AWG wiring for the AC input with #10 AWG internal to the Automatic/Manual Bypass Switch as required for 30 A operations.

3.0 INVERTER/CHARGER FUNCTIONALITY

3.1 Regulated Voltage

The output of the system shall be regulated between 108-130 VAC. When the output of the system can no longer be maintained within this range, the BBS shall transfer to Backup Mode.

3.2 Line Quality Time

The BBS shall have a user definable line qualify time. The user shall be able to select a minimum of three possible settings. The minimum settings shall be 3, 20, and 30 seconds. The default line qualify time shall be 3 or 30 seconds.

3.3 Battery Charger

The BBS shall have an integral charger. The charger shall be a 3-step charger using bulk, absorption and float charging techniques, appropriate for the battery type.

3.4 Temperature Compensation

The integral 3-step charger shall use temperature compensation. The charging system shall compensate over a range of 2.5-4.0 mV/°C per cell.

3.5 Temperature Sensor

A temperature probe which plugs into the front panel of the BBS shall be used to monitor the internal temperature of the batteries. The temperature sensor shall be of sufficient length to properly reach the center battery and yet not too long to cause an inaccurate reading.

3.6 Battery Temperature

The batteries shall not be recharged whenever the battery temperature exceeds 50°C.

3.7 Recharge Time

The recharge time for the batteries from "protective low-cutoff" to 80%, or more, of full charge capacity shall not exceed 12 hours.

4.0 USER INTERFACES AND DISPLAYS

4.1 Inverter/Charger Display

The BBS inverter/charger unit shall include a backlit LCD display for viewing all status and configuration information. The screen shall be easily viewable in both bright sunlight and in darkness.

4.1.1 Screen Size

The screen shall be large enough to display the following information with the use of menu scrolling buttons to read required information:

- Operating Mode
- Utility input voltage
- BBS output voltage
- Charger status

- BBS Status
- Any alarms and faults

4.1.2 Relay Status Information Keypad

The BBS inverter/charger unit shall include a keypad for configuring system parameters and navigating system information.

4.2 Web-based Interface

The BBS shall be provided with a web-based interface for user configuration and management through a web browser.

4.2.1 Minimum Capabilities

The BBS shall allow the user to do the following through the web browser:

- View logs
- Change modes of operation
- Configure email alarms
- Adjust line qualify time
- Program relay contacts
- Configure network parameters

4.3 Status LEDs

The BBS shall have discrete status LED indications on the front of the inverter/charger.

4.3.1 Green Output LED

This LED will be ON any time that the output of the BBS is in Normal Mode. When the output is modified, either by Backup Mode or by Buck/Boost Modes the LED will change state, color or blink green.

4.3.2 Red Fault LED

This LED will be full ON any time that there are any faults in the system

4.3.3 Yellow or Red Flashing Alarm LED

The LED will be full ON yellow or flashing red any time that there are any alarms in the system.

4.3.4 Event Log

The BBS shall maintain an event log containing a minimum of 100 of the most recent events recorded by the BBS. At a minimum, the event log shall record the following:

- Date/time stamp
- Current operating mode
- What the event was

These events shall be downloadable remotely via Ethernet. The event log shall be viewable through the LCD display, EIA-232 port, and the Ethernet Interfaces.

4.3.5 Counters

The BBS shall keep track of the following:

- The number of times that the unit was in Backup Mode.
- The total number of hours and minutes that the unit has operated in Backup Mode since the last reset.

4.4 Programmable Relay Contacts

The BBS shall provide the user six programmable dry relay contacts. As a minimum, the programmable options shall be On Battery, Low Battery, Timer, Alarm, Fault, and Off.

4.4.1 Relay Contact Terminals

The relay contacts shall be made available on the front panel of the BBS via an 18- position, screw hold-down, printed circuit board mounted terminal block.

4.4.2 Contacts

Each relay shall have their own common and their own set of Normally Open (NO) and NC terminals. The terminals for each relay shall be oriented as NO- C-NC on the terminal block.

4.4.3 Labeling

The contacts on the terminal block shall be labeled 1-18, left to right. Additionally, each set of contacts shall be labeled with the NO-C-NC designation as well as C1, C2 ...C6 from left to right. All additional contacts on the terminal block shall be labeled as "spare".

4.4.4 Rating

The relay contacts shall be rated at a minimum of 1 A @125 VAC.

4.4.5 Display

When a relay is energized, it shall be displayed on the LCD screen.

4.4.6 On Battery Relay Contact

The dry relay contacts that are configured for "on battery" shall only energize when the inverter is operating in Backup Mode.

4.4.7 Timer Relay Contact

The BBS shall include a timer that will energize the "timer" configured dry relay contact after the user configured time has elapsed. The timer is started when the BBS enters Backup Mode. The user shall be able to configure the timer from 0-480 minutes in 15-minute increments.

4.4.8 Low Battery Relay Contact

The BBS shall have an adjustable low battery relay setting. This setting shall be adjustable so that the user can set the point at which the low battery relay contact is energized.

5.0 COMMUNICATIONS

5.1 Serial Interface

The BBS shall be equipped with an industry standard RS-232 serial connection for user configuration and management. The serial port shall be a EIA-232 (DB9-Female) connector.

5.2 Ethernet Interface

The BBS shall have an Ethernet communication interface for user configuration and management. The Ethernet Port shall be an RJ-45, EIA 568B Pin Out Connector.

5.3 Remote Monitoring

The BBS shall include remote monitoring & alarms transmission capabilities. These should communicate through the Ethernet RJ45 IP Addressable Port, using SNMP protocol. Other means of communication will be considered.

5.4 User Configurations Menus

All BBS configuration and system menus shall be accessible and programmable from the RS- 232 and Ethernet port.

5.5 Communications Protocols

The BBS shall support TCP and UDP over IP protocol communications.

5.6 Application Layer Protocols

The BBS shall support FTP, Telnet, and HTTP.

5.7 SNMP (Simple Network Management Protocol)

The BBS shall be SNMP compliant.

6.0 BATTERIES

6.1 Battery Type

The battery shall be comprised of extreme temperature, float cycle, GEL VRLA (Valve Regulated Lead Acid). Individual batteries shall meet the following specifications:

- Voltage Rating: 12 V
- Group Size: BCI Case 31, maximum

Batteries shall be commercially available off the shelf.

Batteries shall be replaceable without shutting down power to the entire intersection.

6.2 Battery String

The battery system shall consist of one or more strings of extreme temperature, float cycle, GEL VRLA batteries. Batteries used for the BBS shall not exceed four batteries configured for a 48 VDC battery bus

system. Paralleling multiple strings in order to provide the supplied amp-hour requirements in this specification shall not be acceptable. It shall be an acceptable means for SCDOT to increase the available amp-hours as deemed necessary by paralleling battery banks.

6.3 Operating Temperature

Batteries shall be certified to operate at extreme temperatures from -40°C to +74°C.

6.4 Construction

Battery construction shall include heavy-duty, inter-cell connections for low-impedance between cells, and heavy-duty plates to withstand shock and vibration.

6.4.1 Top Cover

The top cover shall use tongue and groove construction and shall be epoxied or heat- sealed to the battery case for maximum strength and durability.

6.4.2 Ability to Function

The battery shall be designed to function if laid on its side without leakage of chemicals. An integral lifting handle must be provided on the batteries for ease of removal/installation.

6.5 Interconnect Wiring

All batteries shall be provided with the appropriate interconnect wiring.

7.0 BBS CABINET

7.1 General

The unit shall be shelf or rack mounted.

7.1.1 Inverter/Charger Mounting

The Inverter/Charger Unit shall be shelf or rack mounted.

7.1.2 Automatic/Manual Transfer Switch & Generator Switch Mounting

The Automatic/Manual Transfer switch and Generator switch shall be shelf or rack mounted.

7.1.3 Interconnect Wiring

All interconnect wiring shall be provided and shall be UL Style 1015 CSA TEW.

7.2 BBS Replacement

Replacement of the BBS equipment and batteries shall not require any special tools for removal or installation.

7.3 Hot Swappable

The BBS inverter and batteries shall be hot swappable. There shall be no disruption to the traffic signal when removing the inverter or batteries for maintenance

7.4 Quick Disconnects

All inverter and battery connections shall be of the quick disconnect type for ease of maintenance.

7.5 Ancillary Installation Hardware

All necessary installation hardware (bolts, fasteners, washers, shelf angles, racks, etc.) shall be included.

7.6 Cabinet Lighting (Optional)

7.6.1 Cabinet shall have an internal white LED light that is wired to come on when the cabinet door is open.

7.6.2 Cabinet shall have an external "on-battery" red LED indicator light.

7.7 Cabinet Sizing

The external cabinet shall be capable of housing batteries, inverter/charger unit, power transfer switch, control panels, wiring, wiring harnesses, and all other ancillary equipment.

7.8 Additional Cabinet Features

Enclosure shall be made of 0.125" thick traffic grade aluminum. Aluminum alloy shall be 5052, 6061 or equivalent.

- Neoprene gaskets are to be furnished on all doors to prevent dust and moisture from entering the cabinet.
- Cabinet shall include a 3-point latching mechanism with Corbin type 2 lock or Best Lock.
- Cabinet door shall be constructed of stainless steel with a 180 degree piano hinge and two locking open positions.

7.9 Rating

All external cabinets shall be NEMA 3R rated.

7.10 Ventilation

The BBS cabinet shall be ventilated through the use of louvered vents, a filter, and one thermostatically controlled fan.

7.10.1

The fan in the BBS cabinet shall be AC or DC operated.

7.11 Ancillary Hardware

The external cabinet shall come provided with all bolts washers, nuts, cabinet-cabinet coupler fitting, shelves, wiring, and all other hardware necessary for mounting and connecting the external cabinet.

8.0 MAINTENANCE

8.1 Probe Jacks

The BBS shall provide voltmeter standard probe input-jacks (+) and (-) to read the exact battery voltage drop at the inverter input.

8.2 Circuit Breakers

The BBS shall be equipped with an AC input circuit breaker that protects both the UPS and the loads connected to the output. Should the AC input breaker feeding power to the UPS trip, it shall allow the UPS to go to inverter mode to power the intersection off of batteries. Should an overload condition still exist when the inverter is energized, the inverter will revert to its internal electronic protection, preventing damage to the inverter due to the overload or short circuit condition on the output. Once this overload condition is cleared the inverter will energize and power the intersection utilizing the available battery power. If the condition does not clear itself, the inverter will stay in the standby mode until manually cleared by a technician. An AC output breaker that would prevent the inverter from powering the load from batteries when tripped shall not be utilized.

8.3 Accessibility

All components, terminations, terminal blocks, relays, etc. shall be fully accessible.

9.0 Remote Battery Monitoring System (RBMS)

Provide a RBMS to be permanently installed into the UPS/battery cabinet to monitor the four UPS batteries (4-12 V battery blocks). The RBMS shall have the ability to monitor, read and record both the battery string and individual battery voltages, admittance (internal battery resistance), individual battery temperatures and to provide a real-time evaluation of the battery bank health.

The RBMS shall have a built-in web interface for communications over Ethernet. The device shall be hardened and operate at a temperature range of -40°C to +65°C. The device shall include individual 12 V battery sensors and operate in the range of -40°C to +80°C. Communications shall be SNMP via TCP/IP.

10.0 Warranty

10.1 Battery Backup System

The BBS System shall include a five-year warranty on parts and labor on the entire BBS, including batteries, when utilizing the BBS manufacturer's own designed enclosure, meeting the above cabinet specifications.

Should the agency decide not to use the enclosure provided by the BBS manufacturer, the manufacturer must provide a three-year warranty on parts and labor on only the BBS inverter module.

10.2 Batteries

The BBS manufacturer must provide a five-year unconditional full replacement warranty for every battery sold with the BBS under this specification. Under the warranty time period, the battery must provide a minimum of 70% of its original capacity; otherwise it will be considered to be non-compliant to the warranty and replaced at no cost by the BBS manufacturer.

11.0 Measurement

Furnishing components of a Battery Back-up System will be measured by each to include all miscellaneous hardware as required for installation.

12.0 Payment

FURNISH AUTOMATIC/MANUAL BYPASS SWITCH	EA
FURNISH INVERTER/CHARGER	EA
FURNISH INVERTER/CHARGER DISPLAY	EA
FURNISH BATTERIES 12VOLT	EA
FURNISH BATTERY BACKUP SYSTEM CABINET	EA
FURNISH PROBE JACKS	EA
FURNISH CIRCUIT BREAKERS	EA
FURNISH REMOTE BATTERY MONITORING SYSTEM	EA
FURNISH BATTERY BACKUP SYSTEM WITH CABINET	EA
FURNISH BATTERY BACKUP SYSTEM WITHOUT CABINET	EA
FURNISH BATTERY BACKUP FOUNDATION	EA