

**South Carolina Department of  
Transportation**

**REQUEST FOR PROPOSALS**

**(FINAL)**

US Route 701 Bridge Replacements Over  
Yauhannah Lake, Great Pee Dee River, and  
Great Pee Dee Overflow

Project BR88(044)  
Proposal ID 5584230  
P2S 0030684

A Design-Build Project

Georgetown & Horry Counties  
South Carolina

**AUGUST 5, 2014**

# INDEX

# **Replacement of US 701 Bridges over Yauhannah Lake, Great Pee Dee River, and Great Pee Dee Overflow**

## **Design-Build Project**

### **Georgetown & Horry Counties**

**Federal Aid Project No. BR88(044)**

**Proposal ID 5584230**

**P2S 0030684**

## **INDEX**

### **Request for Proposals**

#### **Attachment A – Agreement**

- Exhibit 1. Cost Proposal Bid Form
- Exhibit 2. Schedule of Values
- Exhibit 3. Scope of Work
- Exhibit 4. Project Design Criteria
  - 4a. Roadway
  - 4b. Structures
  - 4c. Pavement
  - 4d. Traffic
    - Part 1 – Signing and Pavement Markings
    - Part 2 – Work Zone Traffic Control
  - 4e. Hydraulic
  - 4f. Geotechnical
- Exhibit 5. Special Provisions
- Exhibit 6. Supplemental Specifications
- Exhibit 7. Federal-Aid Project Supplemental Specifications
- Exhibit 8. Environmental Information
- Exhibit 9. Escrow Documents

#### **Attachment B – Project Information Package**

# **REQUEST FOR PROPOSALS**

*South Carolina Department of Transportation*

**REQUEST FOR PROPOSALS**  
**Final**

**A DESIGN-BUILD PROJECT**

Federal Aid Project No. BR88(044)  
Proposal ID 5584230  
P2S 0030684

**US 701 Bridge Replacements Over Yauhannah Lake, Great  
Pee Dee River, & Great Pee Dee Overflow**

**Georgetown & Horry Counties, South Carolina**

**August 5, 2014**

TABLE OF CONTENTS

**I. PURPOSE OF REQUEST FOR PROPOSALS..... 3**

**II. OVERVIEW ..... 3**

    PROJECT DESCRIPTION..... 3

    PROJECT INFORMATION ..... 4

    SCHEDULE AND LIQUIDATED DAMAGES ..... 4

    RFP COMMITTAL..... 4

    DISADVANTAGED BUSINESS ENTERPRISES ..... 5

    ON-THE-JOB TRAINING REQUIREMENT ..... 5

**III. GENERAL INSTRUCTIONS ..... 5**

    RFP FOR INDUSTRY REVIEW ..... 5

    QUESTIONS, CLARIFICATIONS, AND CONFIDENTIAL ONE-ON-ONE MEETINGS ..... 5

    ALTERNATIVE TECHNICAL CONCEPTS ..... 6

    STIPENDS ..... 11

    PROPOSAL SUBMITTAL ..... 12

**IV. PROJECT SCOPE..... 12**

**V. PROPOSAL DEVELOPMENT ..... 12**

    TECHNICAL PROPOSAL..... 13

    COST PROPOSAL ..... 15

    CONFIDENTIALITY OF PROPOSALS ..... 15

    NONCOLLUSION AND EQUAL EMPLOYMENT OPPORTUNITY CERTIFICATION ..... 15

**VI. EVALUATION OF PROPOSALS..... 15**

    PROPOSAL REVIEW COMMITTEE ..... 15

    PROPOSAL REVIEW ..... 16

    TECHNICAL EVALUATION ..... 16

    PRESENTATIONS..... 17

    CLARIFICATIONS ..... 17

    OPENING OF COST PROPOSALS/BID OPENING MEETING ..... 17

    TOTAL ADJUSTED BID DETERMINATION ..... 18

**VII. SELECTION OF CONTRACTOR..... 19**

**VIII. GENERAL INFORMATION ..... 19**

**XIV. MILESTONES ..... 21**

**XV. COST PROPOSAL BID FORM..... 22**

**XVIII. STIPEND AGREEMENT ..... 26**

# I. PURPOSE OF REQUEST FOR PROPOSALS

The South Carolina Department of Transportation (SCDOT) in cooperation with the Federal Highway Administration (FHWA) seeks to replace the existing bridges along US Route 701 over the Yauhannah Lake, Great Pee Dee River, and Great Pee Dee Overflow. The project will include all items detailed in Exhibit 3 (Scope of Work). The project will be procured and constructed using the Design-Build Procurement method. The purpose of this Request for Proposals (“RFP”) is to select a PROPOSER to perform the project services described in this RFP. SCDOT desires that this project be constructed in a very efficient and timely manner. The proposed project services are hereinafter referred to as the “Project”. “PROPOSER,” as used here, includes a firm or firms, consortia, partnerships, joint ventures, and other legal entities, which have been requested by SCDOT to submit a Proposal in response to this RFP.

It is not the intention of the SCDOT to receive complete detailed project analysis and design prior to the selection of a PROPOSER and the later execution of an agreement. Rather, the response to this RFP shall provide sufficient information to be evaluated to determine if the proposal is in accordance with the specified process and criteria. The Proposal shall be specific enough on assumptions used in its preparation so as to provide the basis for determining a final agreement.

The information obtained under this RFP will become the property of SCDOT without restriction or limitation on its use. With the exception of Alternative Technical Concepts (ATCs), SCDOT shall have unrestricted authority to publish, disclose, distribute, or otherwise use in whole or in part any reports, data, or other materials prepared under this RFP. SCDOT shall retain ownership of all plans, specifications, and related documents.

## II. OVERVIEW

### Project Description

The purpose of this project is to replace three (3) existing bridges including roadway approach work.

SCDOT intends to enter into a contract, for services as detailed in **EXHIBIT 3** (Scope of Work):

The PROPOSER shall be responsible for meeting all Project requirements, specifications, and other applicable criteria as set forth in “Attachments A and B”. If modifications to the plans produced by the PROPOSER are required by the PROPOSER, the PROPOSER shall be responsible for these modifications, any associated permit modifications, right-of-way, utility impacts, and cost thereof. All modifications must meet or exceed the Project requirements.

## **Project Information**

Project Information, containing electronic information applicable to the Project, will be posted on the SCDOT Design Build website. The Project Information Package will include information describing the work, which has been performed by SCDOT prior to entering into the contract for the Project. The Project Information Package is attached to this RFP as “Attachment B”. “Attachment B” may contain additional information not provided at the RFQ stage. Data, reports, plans, electronic files, and any other items supplied in Attachment B and/or posted on the SCDOT Design Build website are for information only. SCDOT shall not be liable for the reliability or accuracy of the information contained therein. Any changes to the documentation provided shall be identified by an addendum to this RFP. PROPOSERS shall acknowledge receipt of addendums in their response to this RFP. It is the PROPOSER’S responsibility to check the website regularly for updates, modifications and additional documentation pertaining to this procurement.

PROPOSERS are encouraged to visit the Project site and to make any additional subsurface explorations or soil tests that PROPOSER may desire for purposes of preparing the Proposal. The PROPOSER shall obtain any permits or permissions required prior to any additional subsurface exploration.

## **Schedule and Liquidated Damages**

It is the intent of SCDOT to complete the Project in a timely manner with minimum interference to normal traffic operations. Liquidated damages shall be assessed in accordance with Article IV of the Agreement.

SCDOT will establish two Notices to Proceed for the Project. Notice to Proceed #1 shall be no later than 45 days from the effective date of the Agreement and will initiate all preconstruction and permitting activities in order to successfully secure all permits for the Project. The duration for these preconstruction and permitting activities has been established as 365 calendar days. SCDOT will only consider time extensions beyond this 365 calendar day timeframe subject to the provisions in Article IX of the Agreement. Notice to Proceed #2 will initiate construction once the 404 permit is secured. Notice to Proceed #2 shall be issued no later than 45 days from the effective date of the 404 permit or 410 calendar days from the **first Notice to Proceed #1**, whichever comes first. The PROPOSER must identify the time required for the construction time of the Project on the Cost Proposal Bid Form.

Construction Time will begin when SCDOT issues Notice to Proceed #2 for the Project and will end with Substantial Work Completion of the Project.

## **RFP Committal**

The submittal of a Proposal in response to this RFP shall constitute the PROPOSER’S agreement to enter into a contract with SCDOT for the completion of the Project under the terms set forth in the Agreement attached hereto as “Attachment A”.



## **Disadvantaged Business Enterprises**

PROPOSER shall comply with Special Provision Disadvantage Business Enterprises (DBE) for Federal-aid Design Build Projects, (Exhibit 5) which incorporates by reference the Disadvantage Business Enterprises (DBE) Supplemental Specification, dated May 2, 2014 (DBE Supplemental Spec) (Exhibit 7). The **DBE Supplemental Specification Agreement** shall identify and set forth the DBE goal for this Project.

If awarded the contract, PROPOSER shall be required to submit a DBE Utilization Plan within thirty (30) days of execution of the Agreement in accordance with the requirements of the Special Provision DBE, which shall include, but not be limited to, the designation of a DBE liaison officer who will be assigned the responsibility of administering and promoting an active and inclusive DBE Program as required by 49 CFR Part 26, SCDOT DBE Special Provision and SCDOT Supplemental Specification.

## **On-The-Job Training Requirement**

The Contract for this Project contains an On-The-Job Training Requirement. The number of persons to be trained under the On-the-Job Training Program during this Project is six (6) for Bridge. The PROPOSER shall comply with the requirements of Attachment A, **EXHIBIT 7**. The Proposer shall submit its plan for On-the-Job Training to SCDOT for written approval prior to commencing construction activities.

# **III. GENERAL INSTRUCTIONS**

## **RFP for Industry Review**

It is the intent of SCDOT to issue an RFP for industry review during the initial stages of this RFP process to allow industry review and comment. After completion of the written clarifications/comment stage as set forth below, a Final RFP will be issued. PROPOSER shall submit their responses to the Final RFP in accordance with the Milestone Schedule.

## **Questions, Clarifications, and Confidential One-On-One Meetings**

Once the RFP for industry review is issued, the PROPOSERS may submit questions or seek clarification relating to the RFP. Questions or requests for clarification shall be in writing and must be received by SCDOT in accordance with the Milestone Schedule. SCDOT will hold Confidential One-on-One Meetings following the review of submitted comments or questions prior to Final RFP release. SCDOT reserves the right to accept or not accept questions received after the milestone deadlines. Changes made to the RFP for Industry Review as a result of the

written questions will be tracked by highlighting the changes in the Final RFP. Verbal responses from SCDOT are for information only and not binding.

Questions or clarifications concerning the RFP or Project shall be directed to:

Mr. Jae H. Mattox, III, P.E.  
SCDOT Point of Contact (POC)  
South Carolina Department of Transportation  
955 Park Street, Room 403  
Post Office Box 191  
Columbia, South Carolina 29202-0191  
803-737-1805  
[mattoxjh@scdot.org](mailto:mattoxjh@scdot.org)

Once the Final/Revised RFP is issued, SCDOT will schedule the second round of confidential one-on-one meetings at the request of the PROPOSERS. By the date specified in the Project Milestones, PROPOSER shall submit written questions and topics for discussion and request a meeting in writing addressed to the POC at the above address. The purpose of the confidential one-on-one meetings is to provide the PROPOSER the opportunity to confidentially discuss the contents of his proposal with SCDOT personnel. Preliminary Concepts may be discussed during the Confidential One-on-One Meetings. SCDOT will determine if questions submitted to or asked at the one-on-one meetings are considered confidential. No additional time will be allowed to research answers. Nothing discussed at the one-on-one meetings shall change the requirements in the RFP. SCDOT will answer the questions at the meeting verbally if possible. Verbal responses are for information only and are not binding. If necessary, written responses that are determined to be of a non-confidential nature will be provided in an addendum to the RFP.

## **Alternative Technical Concepts**

An Alternative Technical Concept (ATC) is a confidential request by a PROPOSER to modify a contract requirement, specifically for that PROPOSER, prior to the Proposal due date. The ATC process provides an opportunity for design-build proposals to promote innovation, find the best solutions, and to maintain flexibility in the procurement process. ATC's are evaluated for approval or denial by SCDOT within the deadline set forth in the RFP Milestone Schedule. In order to be approved, an ATC must be deemed, in SCDOT's sole discretion, to provide a project that is "equal or better" on an overall basis than the project would be without the proposed ATC. Concepts that simply delete scope, lower performance requirements, lower standards, conflict with environmental commitments, or reduce contract requirements are not acceptable as ATC's. SCDOT reserves the right in its sole discretion to reject any ATC.

### **1. Submittal of ATCs:**

- a. Preliminary Concepts: Preliminary concepts may be submitted that present a description adequate for SCDOT to assess the benefits of the concept. Preliminary concepts may be submitted by email from the Design Build Team Project Manager to the SCDOT Point of Contact and

are intended to be an informal inquiry by the PROPOSER to explore a concept and a quick method by SCDOT to review and comment on potential development of ATC prior to investment of time and resources by the PROPOSER. Submission of preliminary concepts does not change or extend the submission deadline of formal ATCs. SCDOT reserves the right to ask PROPOSER to clarify its email. If a preliminary concept receives a favorable response from SCDOT, PROPOSER can elect to submit a formal ATC in accordance with these procedures. A favorable response by SCDOT in no way guarantees that the concept will become an approved ATC. The favorable response may be subject to conditions. **PROPOSER shall be limited to two packages of preliminary concepts and the total number of preliminary concepts shall not exceed twenty (20).** A package is a submittal of 1 or more ATC's. If more than one preliminary concept has been received on the same topic, SCDOT has the right to revise the RFP to include that concept as an addendum to the RFP.

- b. ATC Identification: ATC will be submitted by the PROPOSER and evaluated by SCDOT as set forth in the RFP Milestone Schedule. All ATCs shall be submitted in writing to the POC identified in the RFP with a cover letter clearly identifying the submittal as a request for review of an ATC under this RFP. If the PROPOSER does not clearly designate its submittal as an ATC, the submission will not be treated as an ATC by SCDOT.
- c. **A maximum number of seven (7) ATCs may be submitted to SCDOT by the PROPOSER for consideration.**

## 2. Contents of ATC Submittal:

Each ATC submittal shall include one (1) electronic and one (1) hard-copy and shall include the following:

- a. **Description:** A detailed description and schematic drawings of the configuration of the ATC or other appropriate descriptive information (including, if appropriate, specifications, construction tolerances, special provisions, proposed bridge types, product details, and a traffic operational analysis);
- b. **Usage:** Locations where and an explanation of how the ATC would be used on the Project;
- c. **Deviations:** List in table format, all references to any requirements of the RFP or to any requirements of the Contract Documents that are inconsistent with the proposed ATC. Include an explanation of the nature of the proposed deviation and a request for approval of such deviations or a determination that the ATC is consistent with the requirements of the RFP;

- d. **Justification:** Justify use of the ATC and why the deviations from the requirements of the RFP should be allowed;
- e. **Schedule:** Proposed changes to the Project schedule if applicable;
- f. **Impacts:** Identify potential impacts on vehicular traffic, safety, community, utilities, right of way and the environment;
- g. **History:** A detailed description of other projects where the ATC has been used under comparable circumstances, the success of such usage, and names and telephone numbers of project owners that can confirm such statements;
- h. **Risks:** A description of added risks to SCDOT and other persons associated with implementing the ATC;
- i. **Costs:** An estimate of the impact of the ATC on the Proposal Price and the ATC implementation costs to SCDOT, FHWA, CONTRACTOR, or other person during construction, maintenance and operations;
- j. **Quality:** A description of how the ATC is equal or better in quality and performance than the requirements of the RFP;
- k. **Operations & Maintenance:** Any changes in operation or maintenance requirements associated with the ATC,

### 3. Review of ATCs:

- a. Fourteen Day Review: SCDOT will review each ATC submitted within fourteen (14) calendar days of ATC receipt.
- b. More information Needed: If within seven (7) calendar days of receipt of the ATC SCDOT needs more information to determine whether or not the ATC will be approved or not approved, SCDOT will submit written questions to the PROPOSER and/or request a one-on-one meeting in order to better understand the details of the formal ATC.
  - i. **Questions:** SCDOT may submit written questions to the PROPOSER within seven calendar (7) days of receipt of the ATC. PROPOSER has three (3) calendar days to remit answers. Within four (4) calendar days of receipt of the answers, SCDOT shall respond to the ATC.
  - ii. **One-on-One Meetings:** ATC meeting may be scheduled by SCDOT within seven (7) calendar days of receipt of the ATC. One-on-one meeting(s) may be scheduled to fully understand the details of any formal ATCs. These meetings will be restricted to those persons involved in the review of the ATC and limited to discussions of the PROPOSER'S ATC approach. The purpose of

this meeting is to discuss the proposed changes, answer questions, and other relevant issues. Verbal responses are for information only and are not binding. Nothing stated at any ATC meeting(s) will modify the RFP or Contract documents. SCDOT reserves the right to disclose to all PROPOSERS any issues raised during the ATC meeting(s), either in the Final RFP or in an addendum. However, SCDOT will not disclose any information pertaining to an individual PROPOSER'S ATCs or other technical concepts to other Proposers. SCDOT will issue a written response to PROPOSER regarding its ATC.

- c. No Response from SCDOT: If the PROPOSER does not receive correspondence from SCDOT within fourteen (14) calendar days of SCDOT's receipt of the ATC, the ATC is deemed rejected by SCDOT, unless written notification to extend this period is given by SCDOT. No ATC shall be included in the proposal unless approved by SCDOT in writing prior to the proposal submission deadline.
- d. Conditional Response by SCDOT: If SCDOT issues a conditional answer; an additional 14 days are added to the Fourteen Day Review period: 7 days for PROPOSER to respond to the condition, and 7 days for SCDOT to submit its final response to the ATC.

#### **4. Determination of SCDOT**

- a. SCDOT will make one of the following written determinations with respect to each properly submitted ATC:
  - i. The ATC is approved, in its entirety or in part;
  - ii. The ATC is not approved;
  - iii. The ATC is not approved in its present form, but may be reconsidered for approval upon satisfaction, in SCDOT's sole discretion, of certain identified conditions that must be met or certain clarifications or modifications that must be made by PROPOSER. The PROPOSER shall not have the right to incorporate this ATC into the Proposal unless and until the ATC has been resubmitted within the time limits in the RFP, with the conditions, clarification and modifications satisfied, and SCDOT has unconditionally approved the revised ATC; or
  - iv. The submittal does not qualify as an ATC but appears eligible to be included in the Proposal without an ATC (i.e., the concept appears to conform to the basic configuration and to be consistent with other contract requirements).
  - v. The ATC is deemed to take advantage of an error or omission in the RFP, or other documents incorporated into the contract by reference, the ATC will not be considered, and the RFP will be revised to correct the error or omission.

- vi. More than one formal ATC has been received on the same topic and SCDOT has elected to exercise its right to issue an addendum to the RFP to include that topic.
- b. Once an ATC has been approved, only the entire ATC is eligible for inclusion into the Proposal. The inclusion of partial ATCs into a Proposal is not allowed, unless the individual ATC's have received separate approval by SCDOT
- c. Each PROPOSER, by submittal of its Proposal, acknowledges that the opportunity to submit ATCs was offered to all PROPOSERS, and waives any right to object to SCDOT's determinations regarding acceptability of ATCs.

## **5. Incorporation into Proposal**

- a. A PROPOSER has the option to include any or all approved ATC's in its Proposal. If SCDOT responded to an ATC by identifying conditions for approval, PROPOSER may not incorporate such ATC into the Proposal unless all conditions have been met. Copies of SCDOT's ATC approval letters for each incorporated ATC shall be included in the Technical Proposal. Proposals with or without ATCs will be evaluated against the same technical evaluation factors set forth in the EVALUATION OF PROPOSALS section, and the inclusion of an ATC, including an ATC that provides technical enhancements, may or may not receive a higher technical rating. SCDOT approval of an ATC shall not be considered a guaranty that the proposal incorporating the ATC will be selected. SCDOT's rejection of an ATC will not entitle the PROPOSER to an extension of the Proposal submission deadline on the Milestone Schedule or claim for additional costs or delays, including development costs, loss of anticipated profits, or increased material or labor costs.
- b. The Proposal Price should reflect any incorporated approved ATCs.
- c. Except for incorporating approved ATCs, the Proposal may not otherwise contain exceptions to or deviations from the requirements of the RFP.

## **6. Value Engineering**

An approved ATC that is not incorporated into the proposal will not be considered a pre-approved value engineering change.

## **7. Abandonment of ATC by PROPOSER**

If the approved ATC is abandoned by the PROPOSER, is unable to obtain required approvals, is otherwise proved to be infeasible, or fails to be constructed for any reason, the successful PROPOSER is obligated and required to complete the project utilizing the

original RFP requirements at the awarded cost, and shall be responsible for any redesign costs.

## **8. SCDOT's use of Concepts Contained in an ATC**

SCDOT expressly reserves the right to adopt and use any ATC, approved or disapproved, by the successful PROPOSER on this contract or other contracts administered by SCDOT. By submitting a Proposal, all unsuccessful PROPOSERS acknowledge that upon acceptance of the designated stipend, all approved or disapproved ATC's may be included in this contract or other contracts administered by SCDOT and shall become the property of SCDOT without restriction on use. Prior to contract execution, limited negotiations may be conducted as necessary to incorporate the ideas and concepts from unsuccessful PROPOSERS, provided a stipend is accepted by the unsuccessful offerer.

## **9. PROPOSER Obligations.**

The successful PROPOSER, in addition to performing all other requirements of the Contract Documents, shall:

- a. Obtain and pay the cost of obtaining all required approvals including approvals required to implement any approved ATC(s) incorporated into the Contract Documents;
- b. Obtain and pay the cost of obtaining any third party approvals required to implement any approved ATC(s) incorporated into the Contract Documents; and
- c. Unless otherwise noted in the Contract, be responsible for all costs and/or delays of any nature associated with the implementation of any approved ATC incorporated into the Contract Documents.
- d. Should SCDOT revise the RFP after a formal ATC has been approved, be solely responsible for reviewing the RFP and determining if the ATC deviates from the revised requirements. If required, the PROPOSER must submit a request for approval of all additional variances required within seven (7) calendar days of receipt of the revised RFP.

## **Stipends**

By submitting a Proposal in response to the RFP, the PROPOSER acknowledges the following:

- A. It is the intent of SCDOT to award a stipend of \$60,000.00 to each responsible and responsive PROPOSER subject to the terms of the Stipend Agreement set forth in ARTICLE XIII of the RFP.
- B. PROPOSERS shall indicate on the Stipend Acknowledgement Form in Section XII to the RFP whether it elects to receive a stipend. The Stipend Acknowledgement Form shall be signed and returned with the unsealed Technical Proposal. The Stipend Acknowledgment Form will not count against the specified page limit.

C. If PROPOSER elects to receive a stipend, the Stipend Agreement shall be signed by PROPOSER and submitted as part of the unsealed Technical proposal. The Stipend Agreement will not count against the specified page limit.

## **Proposal Submittal**

**SCDOT has changed the submittal process from previous Design-Build Projects. PROPOSERS are REQUIRED to upload their submittals online through ProjectWise. Only one completed submittal per team will be accepted and shall be uploaded by either the lead contracting entity or lead design firm. Please be advised of the time required to set up new account. All requests for new accounts must be received 72 business hours prior to the proposal deadline indicated in the milestone schedule. More information is available at [http://www.scdot.org/doing/constructionletting\\_projectwise.aspx](http://www.scdot.org/doing/constructionletting_projectwise.aspx).**

**PROPOSERS are to physically deliver and submit ten (10) printed and bound hard copies of the Technical Proposal and conceptual plans. PROPOSERS are to physically deliver one (1) sealed, printed copy of the cost proposal. In addition, the twenty (20) page response, including signed forms, is to be submitted via ProjectWise in PDF format. Please deliver to:**

Contract Administration Engineer  
South Carolina Department of Transportation  
955 Park Street, Room 333  
Post Office Box 191  
Columbia, South Carolina 29202-0191

## **IV. PROJECT SCOPE**

See EXHIBIT 3.

## **V. PROPOSAL DEVELOPMENT**

Proposals must be submitted separately in two parts, a Technical Proposal and a Cost Proposal. The Technical Proposal shall contain no more than twenty (20) pages, excluding any plans and appendices. The Technical Proposal shall be single sided, with minimum twelve-point (12) Times New Roman font and double line spacing for text. The Cost Proposal shall be bound and sealed separately from the Technical Proposal. The Cost Proposal shall be clearly marked as “Confidential Proprietary Information” by the PROPOSER and shall include the completed Cost Proposal Bid Form. Responses should address all of the items listed below. If a PROPOSER does not, at a minimum, submit responses to these items, the submittal may be considered non-responsive and returned without further review/evaluation. In order to meet the minimum requirements of this RFP, PROPOSER must provide responses to each of the items listed.



**Beyond the minimum requirements**, a maximum of 100 quality credit points are available to the PROPOSER based on the commitments to the bolded items below. **Responses must be in the form of commitments in order to receive quality credit. All Project commitments above and beyond the requirements of the RFP, supported in the technical narrative, shall be summarized in a matrix in a clear and concise manner. The Commitment Matrix shall not count against the specified page limit.** Conceptual plans that conflict with RFP requirements, and are not submitted under the ATC process, may result in the proposal being deemed non-responsive. Any concepts that conflict with the RFP specifications discovered after award of the Project, and which are not approved as an ATC, shall not prevail over RFP specifications. Point values for each of the bolded items are shown at the end of each item.

PROPOSERS are advised that SCDOT reserves the right to conduct an independent investigation of any information, including prior experience, identified in the responses. PROPOSERS are responsible for affecting delivery by the deadline dates. Late submissions will be rejected without opening. SCDOT accepts no responsibility for misdirected or lost proposals.

## **Technical Proposal**

PROPOSERS must provide responses to the items below in order to provide SCDOT a general overview of the PROPOSER'S approach to the Project. The 100 quality credit points will be based on the conceptual plans and commitments made in the responses to the items below:

In order that evaluation may be accomplished efficiently, the Technical Proposal shall be prepared in the following sequence:

1. Conceptual Roadway Plans (half-sized) which shall consist of:
  - a. Plan and Profile of roadway approaches
  - b. Typical Section
  - c. Horizontal Geometry
  - d. Existing and Proposed Right of Way
  - e. Proposed Retaining Walls, Designed Fills, and Temporary Shoring
  - f. Construction Limits
  - g. Environmentally Sensitive Areas including Wetlands, Streams, etc.
  - h. Location of Boat Ramp
  
2. Conceptual Bridge Plans (half-sized) which shall consist of:
  - a. Title Sheet
  - b. Plan and Profile of the bridges showing the proposed type of superstructure and substructure and existing ground profiles at the bridge site.
  - c. Superstructure cross section showing pertinent structural elements
  - d. Horizontal and Vertical Clearances
  - e. Locations and types of proposed bearings and expansion joints.

3. Conceptual Maintenance of Traffic Plans depicting the number of construction stages and a staging narrative to include duration of each stage.

PROPOSERS must provide responses to the items below in order to provide SCDOT a general overview of the PROPOSER'S approach to the Project. **The conceptual plans required above and the technical proposal narrative will be utilized to evaluate the responses below.** The 100 total quality credit points available will be based on the commitments in the responses to the items below:

1. Describe the approach and team commitment in design, construction, and agency coordination to minimize impacts to the environmental resources. Quantify and describe all environmental impacts associated with the approach and project delivery. Items to consider:
  - i. Availability of boat ramp during construction and final location of facility
  - ii. Impact to Waccamaw National Wildlife Refuge
  - iii. Avoidance and Minimization of wetland impacts
  - iv. Minimization of right of way impacts
  - v. Minimization of impacts to traffic

Quantify and describe all environmental impacts associated with the approach and project delivery. (~~60 points~~ 50 points)

2. Identify commitments of materials, designs, and construction methods that would minimize maintenance costs in the future to the SCDOT and benefit the project. Potential commitments could involve reducing the use of steel bridge components, installing low maintenance drainage components and expansion joints, installing longer-life pavement, etc. (~~20 points~~ 15 points)
3. Describe any additional improvements or tasks that will be included in the Project including but not limited to additional warranties, enhancements, and assumed Project risk. Potential items could include landscaping, extension of roadway items such as resurfacing on mainline and/or side roads, installation/replacement of signage, enhancement of Refuge trails and boat ramp access area, increased public involvement, etc. (10 points)
4. Describe the team's commitment to minimizing impacts to existing bridges and embankments traffic. Potential considerations include construction methods, degree of which existing bridge will be used, limiting vibration producing activities lane/nighttime closures, etc. (~~10 points~~ 25 points)

**All Project commitments above and beyond the requirements of the RFP, supported in the technical narrative, shall be summarized in a matrix in a clear and concise manner.**

Note: Drawings and plans requested as part of the Technical Proposal shall not count against the specified page limit and can be included in the Appendix.

REQUEST FOR PROPOSALS

US Route 701 Bridge Replacements Over Yauhannah Lake, Great Pee Dee River, and Great Pee Dee Overflow  
P2S 0030684, Proposal ID 5584230, Federal Aid Project No. BR88(044)  
Georgetown & Horry Counties, South Carolina

## **Cost Proposal**

PROPOSERS shall complete the Cost Proposal Bid Form provided at the end of this document. The Cost Proposal Bid Form shall be sealed in a separate envelope and delivered as part of the Cost Proposal per the Milestone Schedule.

## **Confidentiality of Proposals**

PROPOSER shall specifically mark any elements that are deemed confidential, or proprietary. All markings must be conspicuous; use color, bold, underlining, or some other method in order to conspicuously distinguish the mark from the other text. Do not mark the entire proposal as confidential or proprietary. In determining whether to release documents, the SCDOT will rely on PROPOSER's marking of each page or portions of pages of documents, as required by these instructions, as being either "Confidential" or "Trade Secret". PROPOSER shall be prepared upon request to provide justification of why such materials shall not be disclosed under the South Carolina Freedom of Information Act, Section 30-4-10, et seq., South Carolina Code of Laws (1976) as amended. Proposals will be kept confidential and will not be disclosed, except as may be required by law.

## **Noncollusion and Equal Employment Opportunity Certification**

PROPOSERS shall certify that they have not participated in any collusion or otherwise taken any action in restraint of free competitive bidding in connection with the submission of this proposal on this Project. Proposal submitted without the non-collusion certification may be deemed non-responsive. The non-collusion certification form provided as part of this document shall be submitted as part of the Technical proposal and will not count against the specified page limit.

PROPOSERS shall complete the Equal Employment Opportunity (EEO) Performance Certification form provided as part of this document. Proposal submitted without the EEO certification may be deemed non-responsive. The EEO certification form shall be submitted as part of the Technical proposal and will not count against the specified page limit.

# **VI. EVALUATION OF PROPOSALS**

## **Proposal Review Committee**

A Proposal Review Committee ("Committee") will be appointed by SCDOT to review the Proposals. The voting members will be comprised of SCDOT employees. In addition, SCDOT will assemble a group of non-voting resource members having expertise in the various disciplines required by the Project including the Federal Highway Administration.

## **Proposal Review**

The Committee will review the Proposals and determine whether each Proposal is responsive. Responsive Proposals will be accepted by the Committee for evaluation. Any non-responsive Proposal will be returned to the PROPOSER, at the Opening of Cost Proposals/Bid Opening Meeting set forth on the Milestone Schedule, with a detailed explanation as to reasons for determining non-responsiveness. Reasons for determining a proposal to be non-responsive may result from, but are not limited to, the following: failure to provide all information requested in the proposal, failure to conform to the material requirements of the RFP, conflict of interests, conditional proposals, failure to provide complete and honest information, failure to complete the Cost Proposal Bid Form correctly, or failure to submit the EEO certification. Responsive Proposals will be evaluated and scored by the Committee. Proposals which impose conditions that modify material requirements of the RFP may be rejected as non-responsive. Proposers will not be given an opportunity to correct any material nonconformity. Any deficiency resulting from a minor informality may be clarified or waived at the sole discretion of the SCDOT.

## **Technical Evaluation**

All Proposals will be evaluated for technical merit prior to opening the cost proposals. The Committee will determine responsiveness of the Technical Proposal based on responses to all items requested in the RFP. For the items that have quality credit points associated with them, the Committee will utilize the table below entitled “Quality Credit Percentage for Technical Proposals” to assign a quality credit percentage to each Proposal based on the PROPOSER’s overall quality score. The maximum quality credit percentage for this project will be 5%.

### **Quality Credit Percentage for Technical Proposals**

Quality Points	Quality Credit (%)
100	5.0
90	4.5
80	4.0
70	3.5
60	3.0
50	2.5
40	2.0
30	1.5
20	1.0
10	0.5
0	0.0

## **Presentations**

PROPOSERS who have submitted responsive Technical Proposals may be invited by the Committee to make a presentation. The presentation, if required, will allow the PROPOSERS an opportunity to further explain any aspect of their Technical Proposals. The Committee may address questions to the PROPOSER after the presentation.

## **Clarifications**

SCDOT, at its sole discretion, shall have the right to seek clarifications from any PROPOSER to fully understand information contained in their responses to the RFP. Clarifications mean a written or oral exchange of information which takes place after the receipt of proposals when award without discussions is contemplated. The purpose of clarifications is to address minor or clerical revisions in a proposal.

## **Opening of Cost Proposals/Bid Opening Meeting**

All Technical Proposals will be evaluated for responsiveness based on those items requested in this RFP. Those Technical Proposals deemed non-responsive for any reason will be returned to the PROPOSER along with the PROPOSER's unopened Cost Proposal prior to the opening of Cost Proposals. As detailed above, those Technical Proposals deemed responsive will be scored according to the information provided in this RFP. Based upon that score, a quality credit percentage will be applied to the PROPOSER's Cost Proposal, in accordance with the table shown above. The quality credit percentage will be provided confidentially in a sealed envelope to each PROPOSER at the Opening of Cost Proposals/Bid Opening meeting as shown on the Milestones Schedule in Section IX of this RFP.

Cost Proposals of PROPOSERS with responsive Technical Proposals will be opened at the meeting. The Total Bid amount shown on the Cost Proposal Bid Form and the Quality Credit Score for each respective PROPOSER will be entered into a spreadsheet and analyzed. Each Cost Proposal will be compared against the confidential SCDOT Engineer's Estimate.

If upon analysis, one or more of the Total Adjusted Bids is within an acceptable range of the Engineer's Estimate, all Total Bid Amounts (including A and B portions if applicable) and Quality Credit Scores for each PROPOSER will be read aloud and the proposals will be ranked based on the lowest Total Adjusted Bid.

If upon analysis, all of the Total Adjusted Bids exceed an acceptable range of the Engineer's Estimate, only the Total Bid Amounts (including the A and B portions if applicable) will be read and the Quality Credit Scores for each PROPOSER will remain confidential and be known only to each respective PROPOSER. The meeting will then adjourn so that SCDOT personnel may assess if either award outside the prescribed range is justified or if the SCDOT will hold discussions and may request a Best and Final Offer (BAFO) from all responsive PROPOSERS.

In the event that SCDOT elects NOT to proceed with a Best and Final Offer (BAFO), then SCDOT will schedule a date and time to publicly reiterate all Total Bids Amounts and read all Technical Scores.

SCDOT intends to award the contract to the PROPOSER with the lowest Total Adjusted Bid. However, the RFP may be cancelled after opening, but prior to the issuance of an award, when such action is determined in writing to clearly be in the best interest of the State. If the RFP is cancelled, proposals shall be returned to the PROPOSERS and a new solicitation may be conducted for the Project.

**Total Adjusted Bid Determination**

The Adjusted Low Bid method will be utilized in determining the Total Bid to determine the lowest adjusted bid. Award of the Contract, if made, will be made to the responsible and qualified PROPOSER who submits the lowest Total Adjusted Bid. In the event that two or more PROPOSERS are determined to have the same lowest total adjusted bid, the award, if made, will be made to the PROPOSER with the highest quality credit score. The following formula will be used to evaluate the values given on the Cost Proposal Bid Form:

Total Adjusted Bid = A - [A x Quality Credit] + B:

- A Total Cost to Complete all work to be performed under the contract
- B Project Construction Time Cost (B = b x dc)
- b Construction time (b) is defined as calendar days from Notice to Proceed #2 to Substantial Work Completion of the Project.
- dc Daily cost associated with the Project as stipulated on the Cost Proposal Bid Form (\$4,000 per day)

Quality Credit is the assigned quality credit percentage as a result of the proposal’s technical score; expressed as a decimal.

Example for Determining Total Adjusted Bid

Proposal	Quality Points	Quality Credit (%)	Cost Proposal (A)	Quality Value	Construction Time (b)	Total Adjusted Bid
A	100	5.0	\$100,000,000	5,000,000	1000	99,000,000
B	80	4.0	105,000,000	4,200,000	750	103,800,000
C	60	3.0	110,000,000	3,300,000	800	109,900,000
D	70	3.5	107,000,000	3,745,000	850	106,655,000

Note: In this example, Proposal A was determined to be the lowest total adjusted bid

## VII. SELECTION OF CONTRACTOR

The Committee will present a report regarding their review of the proposals to SCDOT Deputy Secretary for Engineering and recommend selection of the PROPOSER with the lowest Total Adjusted Bid. Upon approval, SCDOT will offer a contract to the selected PROPOSER. *However, if the parties are unable to execute a contract, SCDOT may offer a contract to the PROPOSER with the next lowest Total Adjusted Bid.*

The Design-Build Agreement will be executed for the Total Cost to Complete as shown in the Cost Proposal Bid Form and the Project Construction Time will be the Total Number of Calendar Days from Notice to Proceed #2 to Substantial Work Completion of the Project. Construction time for the Project shall be established as shown on the Cost Proposal Bid Form.

## VIII. GENERAL INFORMATION

- I. SCDOT reserves the right to terminate evaluation of one or more of the proposals if it is determined to be in the best interest of the state to do so.
- II. SCDOT reserves the right, at its sole discretion, to either cancel this solicitation or to re-advertise in another public solicitation when it is in the best interest of the state to do so.
- III. SCDOT reserves the right to reject any and all proposals, or parts thereof, and/or to discontinue contract execution with any party at any time prior to final contract execution.
- IV. SCDOT assumes no liability and will not reimburse costs incurred by firms, whether selected or not, in developing proposals or in contract execution.
- V. SCDOT reserves the right to request or obtain additional information about any and all proposals. SCDOT may also issue addenda to the RFP, which will be mailed to all RFP holders.
- VI. SCDOT reserves the right to revise or amend the RFP, specifications and/or drawings, including changes to the date the proposal is due. Such changes, if any, will be announced by an addendum or addendums to this Request for Proposal. All information relating to this RFP, including pertinent changes/addendums and other applicable information will be posted on SCDOT's design build website [www.SCDOT.org](http://www.SCDOT.org) a minimum of ten (10) business days prior to the date set for receipt of proposals as set forth in the Milestone Schedule. If changes are made to the RFP within ten (10) days of the due date, Milestones may be adjusted accordingly. **PROPOSERS are strongly cautioned to check this site frequently to ensure they have the latest information.**

### REQUEST FOR PROPOSALS

US Route 701 Bridge Replacements Over Yauhannah Lake, Great Pee Dee River, and Great Pee Dee Overflow  
P2S 0030684, Proposal ID 5584230, Federal Aid Project No. BR88(044)  
Georgetown & Horry Counties, South Carolina

- VII. Receipt of an addendum by the PROPOSER must be acknowledged in the space provided on the Addendum Notice to Proposer Transmittal Form posted on the SCDOT Design Build website for this project. PROPOSERS shall submit the signed Notice with its Technical Proposal response to this RFP. Failure to acknowledge an addendum may result in rejection of the proposal. Explanations or instructions given in a form other than an addendum or ATC response letter shall not be binding.
- VIII. After award, if an unsuccessful PROPOSER would like to schedule a debriefing, PROPOSER shall submit a request within three (3) business days from the date the award notification is posted on the SCDOT Design Build website for this Project. Only written requests (emails are acceptable) for a debriefing will be scheduled. Failure to request a debriefing within the three (3) business day period waives the opportunity for a debriefing.
- IX. All PROPOSERS must visibly mark as “CONFIDENTIAL” each part of their submission that they consider to contain proprietary information the release of which would constitute an unreasonable invasion of privacy. All unmarked pages will be subject to release in accordance with law. PROPOSER should be prepared, upon request, to provide justification of why such materials should not be disclosed under the South Carolina Freedom of Information Act, S.C. Code Section 30-4-10, et seq.
- X. PROPOSER shall be held responsible for the validity of all information supplied in its proposal, including that provided by potential subcontractors. Should subsequent investigation disclose that the facts and conditions were not as stated, the proposal may be rejected or contract terminated for default if after award, in addition to any other remedy available under the contract or by law.
- XI. PROPOSER, by submitting a proposal, represents that it has read and understands the RFP, its exhibits, attachments and addendums, and that its proposal is made in compliance with the criteria of the RFP. PROPOSERS are expected to examine the RFP, its exhibits, attachments and addendums thoroughly and should request an explanation of any ambiguities, discrepancies, errors, omissions, or conflicting statements therein. Failure to do so will be at the PROPOSER's risk. PROPOSER assumes responsibility for any patent ambiguity in the RFP, its exhibits, attachments and addendums that PROPOSER does not bring to SCDOT's attention.
- XII. No proposal guaranty in the form of a Bid Bond is required for this procurement.
- XIII. Proposal Acceptance Period - By submitting proposal, PROPOSER agrees to hold proposal offer available for acceptance a minimum of ninety (90) calendar days after the Bid Opening date.

REQUEST FOR PROPOSALS



## XIV. MILESTONES

Provide RFP for Industry Review to Selected Short-list PROPOSERS	Thursday, June 12, 2014
Deadline Clarifications/Comments to be submitted by PROPOSERS	Thursday, June 26, 2014
Confidential One-on-One meetings with PROPOSERS	Wednesday, July 16, 2014
Issue Final RFP	Tuesday, August 5, 2014
Preliminary ATC <b>Concepts</b> Submittals (Start)	Wednesday, August 6, 2014
Confidential RFP <b>Questions</b> and <b>Preliminary</b> ATC to be submitted by PROPOSERS	Monday, August 18, 2014
Confidential RFP and ATC One-on-One meetings with PROPOSERS	Wednesday, August 27, 2014
Begin Formal ATC Process	Wednesday, August 27, 2014
All Formal ATC's SHALL be submitted prior to	Wednesday, September 17, 2014
Submittal of Proposals	Wednesday, October 29, 2014 by 2:00 PM EDT.
Bid Opening(with team representatives present)	Wednesday, November 12, 2014
Notification of Selection	November 2014
Award/Contract Execution	SCDOT Commission Meeting December 4, 2014

### REQUEST FOR PROPOSALS

US Route 701 Bridge Replacements Over Yauhannah Lake, Great Pee Dee River, and Great Pee Dee Overflow  
P2S 0030684, Proposal ID 5584230, Federal Aid Project No. BR88(044)  
Georgetown & Horry Counties, South Carolina

# XV. COST PROPOSAL BID FORM

## US Route 701 Bridge Replacements Over Yauhannah Lake, Great Pee Dee River, and Great Pee Dee Overflow

### Georgetown & Horry Counties

CONTRACTOR: \_\_\_\_\_

ADDRESS: \_\_\_\_\_

Provide full project scope as described in Attachment A.

TOTAL COST TO COMPLETE (A)= \_\_\_\_\_

dc (Daily Cost of Project) = \$4,000

CONSTRUCTION TIME (b) IS DEFINED AS CALENDAR DAYS FROM NOTICE TO PROCEED #2 TO SUBSTANTIAL WORK COMPLETION OF THE PROJECT. NOTICE TO PROCEED #2 SHALL BE NO LATER THAN 45 DAYS FROM THE EFFECTIVE DATE OF THE 404 PERMIT OR 410 DAYS FROM NOTICE TO PROCEED #1, WHICHEVER COMES FIRST.

Construction Time (Calendar Days)(b)= \_\_\_\_\_

Project Construction Time Cost (B) = \_\_\_\_\_

TOTAL BID (A+B) = \_\_\_\_\_

**No conditional Bids will be accepted. SCDOT reserves the right to delete any or all conditions placed on the Total Cost to Complete, and/or reserves the right to reject any Bid that is conditional or contains additions not called for in the plans and specifications.**

\_\_\_\_\_  
Signature

\_\_\_\_\_  
Date

\_\_\_\_\_  
Printed Name

# XVI. NON-COLLUSION AND EEO CERTIFICATIONS

## NON-COLLUSION CERTIFICATION

**Federal Project: BR88(044)**

**State Project: P2S 0030684, Proposal ID 5584230**

IN ACCORDANCE WITH THE PROVISIONS OF S.C. CODE ANN. §§ 39-3-10 ET.SEQ., 39-5-10 ET. SEQ., 15 U.S.C. §45; 23 C.F.R. §635.112(F); AND 28 U.S.C. §1746, I HEREBY ACKNOWLEDGE THAT I AM AN OFFICER OF THE PROPOSER FIRM AND, UNDER PENALTY OF PERJURY UNDER THE LAWS OF THE UNITED STATES AND SOUTH CAROLINA, DECLARE, BY MY CERTIFICATION BELOW, THAT THE FOLLOWING IS TRUE AND CORRECT, AND FURTHER, THAT THIS FIRM, ASSOCIATION OR CORPORATION HAS NOT, EITHER DIRECTLY OR INDIRECTLY, ENTERED INTO ANY AGREEMENT, PARTICIPATED IN ANY COLLUSION, OR OTHERWISE TAKEN ANY ACTION IN RESTRAINT OF FREE COMPETITIVE BIDDING IN CONNECTION WITH THE SUBMISSION OF A BID PROPOSAL ON THE ABOVE REFERENCED PROJECT.

BY CHECKING THIS BOX  , I CERTIFY THAT I HAVE READ, UNDERSTAND, ACCEPT, AND ACKNOWLEDGE ALL OF THE ABOVE STATEMENTS.

Executed on \_\_\_\_\_  
(Date)

Signed: \_\_\_\_\_  
(Officer/Proposer)

\_\_\_\_\_  
(Title)

\_\_\_\_\_  
(Address)

\_\_\_\_\_

(COMPLETE THIS SECTION FOR FEDERAL PROJECTS ONLY)  
**EQUAL EMPLOYMENT OPPORTUNITY PERFORMANCE**

Select the Certification that applies to the PROPOSER:

**Certification (1)**  **or** **Certification (2)**

Select the appropriate responses in the applicable Certification:

**Certification (1):** Pursuant to 41 C.F.R. §60-1.7(b)(1), Previous Equal Employment Opportunity Performance Certification, as the Prospective Prime Contractor, **I HEREBY CERTIFY THAT I:**

- (a) **(HAVE / HAVE NOT)** developed and filed an Affirmative Action Program pursuant to 41 C.F.R. §60-2;
- (b) **(HAVE / HAVE NOT)** participated in a previous contract or subcontract subject to the equal opportunity clause;
- (c) **(HAVE / HAVE NOT)** filed with the Joint Reporting Committee, the Director of Office of Federal Contract Compliance, or the Equal Employment Opportunity Commission, all reports due under the applicable filing requirements,

**OR**

Certification (2): **I, HEREBY CERTIFY** that as the Prospective Prime Contractor submitting this Proposal, **(CLAIM / DO NOT CLAIM)** exemption from the submission of the Standard Form 100 (EEO-1) due to the fact that it employs a total of less than fifty (50) employees under C.F.R. §60-1.7, or qualifies for an exempted status under 41 C.F.R. §60-1.5.

**I FURTHER CERTIFY** that the above Certification will be made part of any Subcontract Agreement involved with this project.

Executed on \_\_\_\_\_, 20\_\_.

Signed: \_\_\_\_\_

(Officer/Proposer)

\_\_\_\_\_  
(Title)

\_\_\_\_\_  
(Company)

\_\_\_\_\_  
(Address)

SEAL

# XVII. STIPEND ACKNOWLEDGEMENT FORM

## Stipend Acknowledgement Form

### US Route 701 Bridge Replacements Over Yauhannah Lake, Great Pee Dee River, and Great Pee Dee Overflow

### Georgetown & Horry Counties

PROPOSER: \_\_\_\_\_

ADDRESS: \_\_\_\_\_

The undersigned PROPOSER, hereby:

Waives the stipend for this Project.

Accepts the stipend for this Project.

By accepting the stipend for this Project, PROPOSER agrees:

- 1) to execute and include the Stipend Agreement in Article XIII of the RFP with their RFP response;
- 2) SCDOT will pay the stipend to each eligible unsuccessful PROPOSER, who has signed a Stipend Agreement, within ninety (90) days after execution of the contract or the decision not to award a contract;
- 3) to transfer all rights to its Work Product used to develop the proposal as of the date of this acknowledgement. "Work Product" means all submittals, including ATCs, ideas, innovations, solutions, methods, processes, design concepts, materials, electronic files, marked up drawings, cross sections, quantity lists and intellectual property, made by PROPOSER during the RFP process, including the proposal, exchange of information during the pre-proposal and post-proposal period.

\_\_\_\_\_  
Date

\_\_\_\_\_  
PROPOSER

\_\_\_\_\_  
Print Name

# XVIII. STIPEND AGREEMENT

## STIPEND AGREEMENT

P2S No.: 0030684; Proposal ID 5584230

**Project Description: US Route 701 Bridge Replacements Over Yauhannah Lake, Great Pee Dee River, and Great Pee Dee Overflow - Georgetown & Horry Counties**

**THIS STIPEND AGREEMENT** (the "Agreement") is made and entered into as of the \_\_\_ day of \_\_\_\_\_, 20\_, by and between the SOUTH CAROLINA DEPARTMENT OF TRANSPORTATION (hereinafter "SCDOT"), and \_\_\_\_\_ ("PROPOSER"), with reference to the following facts:

SCDOT issued a Request for Proposal ("RFP") for design and construction of the above-referenced Design-Build Project ("Project"), pursuant to procurement authority granted in Section 57-5-1625 of the S.C. Code of Laws, 1976, as amended. The RFP provided for payment of stipends as provided herein.

**NOW, THEREFORE, PROPOSER** hereby agrees as follows:

### 1. Work Product.

**1.1** PROPOSER shall prepare and submit a responsible and responsive technical and cost proposal that conforms in all material respects to the requirements and provisions of the RFP, as determined by SCDOT, and are timely received by SCDOT in accordance with the RFP Milestone Schedule.

**1.2** By signing this Stipend Agreement, PROPOSER agrees to transfer ownership to SCDOT of the electronic copy and hard copy of all Work Product used to develop the proposal. The Work Product (as defined below) shall become the property of SCDOT without restriction or limitation on its use, without further compensation or consideration, and can be used in connection with this Project or any future projects by SCDOT. Neither PROPOSER nor any of its team members shall copyright any of the material developed under this Agreement.

**1.3** The term "Work Product" shall mean all material, electronic files, marked up drawings, cross sections, quantity lists, submittals, alternative technical concepts (ATC), ideas, innovations, solutions, methods, processes, design concepts, and intellectual property, made by or produced for PROPOSER in the development and submission of the technical and price proposals, including exchanges of information during the pre-proposal and post-proposal period.

### 2. Compensation and Payment.

**2.1** A stipend to PROPOSER for the Work Product described herein shall be ~~\$60,000.00~~ and is payable on condition that PROPOSER (1) submitted a responsible and responsive technical and cost proposal to the RFP which is not selected for award of this Project, or (2) was awarded the Contract but the Contract was terminated by SCDOT at SCDOT's convenience after the Submittal of Proposal Date (See Final RFP Milestone schedule) but prior to the **Notice to Proceed #1**. Responsibility and responsiveness of the proposal will be determined by SCDOT as a condition of payment.

**2.2** SCDOT will pay the stipend to PROPOSER under the following conditions:

(a) Within ninety (90) days after execution of the contract or the decision not to award a contract, SCDOT will pay the stipend to the unsuccessful PROPOSER meeting the criteria of Section 2.1, provided that the PROPOSER submitted a signed a Stipend Agreement with its response to the RFP.

(b) If the procurement is suspended or cancelled prior to the Proposal Due Date (see FINAL RFP Milestone schedule), no stipend will be paid to PROPOSER.

(c) After the submittal of proposals, but prior to award, if the procurement is cancelled, all PROPOSERS that provide a responsive technical and cost proposal to the final RFP and submitted a signed Stipend Agreement with their RFP shall receive the stipend

(d) In the event of a Best and Final Offer, only one stipend will be paid.

(e) No stipends will be paid for submitting RFQ responses.

**2.3** Acceptance by the PROPOSER of payment of the stipend amount from SCDOT shall constitute a waiver by PROPOSER of any and all right, equitable or otherwise, to bring any claim in connection with this procurement, procurement process, award of the Contract, or cancellation of this procurement.

**2.4** The PROPOSER awarded the contract shall be not eligible to receive a stipend.

**2.5** If PROPOSER elects to waive payment of the stipend, SCDOT will not use the ideas or information contained in that PROPOSER's proposal for this Project. However, the PROPOSER's proposal will be subject to the South Carolina Freedom of Information Act.

## REQUEST FOR PROPOSALS

US Route 701 Bridge Replacements Over Yauhannah Lake, Great Pee Dee River, and Great Pee Dee Overflow  
P2S 0030684, Proposal ID 5584230, Federal Aid Project No. BR88(044)  
Georgetown & Horry Counties, South Carolina

**3. Indemnities.**

3.1 Subject to the limitations contained in Section 3.2, PROPOSER shall indemnify, protect and hold harmless SCDOT and its directors, officers, employees and contractors from, and PROPOSER shall defend at its own expense, all claims, costs, expenses, liabilities, demands, or suits at law or equity arising in whole or in part from the negligence or willful misconduct of PROPOSER or any of its agents, officers, employees, representatives or subcontractors or breach of any of PROPOSER’s obligations under this Agreement.

3.2 This indemnity shall not apply with respect to any claims, demands or suits arising from use of the Work Product by SCDOT.

**4. Compliance With Laws.**

4.1 PROPOSER shall comply with all federal, state, and local laws, ordinances, rules, and regulations applicable to the work performed or paid for under this Agreement and covenants and agrees that it and its employees shall be bound by the standards of conduct provided in applicable laws, ordinances, rules, and regulations as they relate to work performed under this Agreement. PROPOSER agrees to incorporate the provisions of this paragraph in any subcontract into which it might enter with reference to the work performed pursuant to this Agreement.

4.2 The PROPOSER agrees (a) not to discriminate in any manner against an employee or applicant for employment because of race, color, religion, creed, age, sex, marital status, national origin, ancestry or disability of a qualified individual with a disability; (b) to include a provision similar to that contained in subsection (a) in any subcontract; and (c) to post and to cause subcontractors to post in conspicuous places available to employees and applicants for employment, notices setting forth the substance of this clause.

**5. Assignment.**

PROPOSER shall not assign this Agreement without SCDOT’s prior written consent. Any assignment of this Agreement without such consent shall be null and void.

**6. Miscellaneous.**

6.1 PROPOSER and SCDOT agree that PROPOSER, its team members, and their respective employees are not agents of SCDOT as a result of this Agreement.

6.2 This Agreement, together with the RFP, as amended from time to time, the provisions of which are incorporated herein by reference, embodies the entire agreement of the parties. There are no promises, terms, conditions, or obligations other than those contained herein or in the RFP, and this Agreement shall supersede all previous communications, representation, or agreements, either verbal or written, between the parties hereto.

6.3 It is understood and agreed by the parties hereto that if any part, term, or provision of this Agreement is by the courts held to be illegal or in conflict with any law of the State of South Carolina, the validity of the remaining portions or provisions shall not be affected, and the rights and obligations of the parties shall be construed and enforced as if the Agreement did not contain the particular part, term, or provisions to be invalid.

6.4 This Agreement shall be governed by and construed in accordance with the laws of the State of South Carolina.

**IN WITNESS WHEREOF**, the parties have executed this Agreement as of the date first written above.

Witness:  
\_\_\_\_\_

SOUTH CAROLINA DEPARTMENT  
OF TRANSPORTATION

By: \_\_\_\_\_  
John D. Boylston, P.E.  
Regional Production Engineer

Recommended:  
\_\_\_\_\_  
Jae Mattox, P.E.  
Program Manager

PROPOSER  
\_\_\_\_\_  
Name of PROPOSER

Witness:  
\_\_\_\_\_  
\_\_\_\_\_

By: \_\_\_\_\_  
Its: \_\_\_\_\_

# **AGREEMENT**



**AGREEMENT**  
**FOR THE DESIGN & CONSTRUCTION**  
**of**  
US 701 Bridge Replacements over  
Yauhannah Lake, Great Pee Dee River, & Great Pee Dee Overflow  
Georgetown & Horry Counties, South Carolina

*A DESIGN-BUILD PROJECT*

**BETWEEN**  
**SOUTH CAROLINA DEPARTMENT OF TRANSPORTATION**  
**AND**

\_\_\_\_\_ day of \_\_\_\_\_, 2014

SC Proposal ID 5584230; P2S 0030684  
Federal Aid Project No. BR88(044)

Agreement for US 701 Bridge Replacements  
Georgetown & Horry Counties

TABLE OF CONTENTS	Page Number
LIST OF EXHIBITS.....	4
I. CONTRACT DOCUMENTS .....	6
II. PROJECT SCOPE .....	6
A. Scope of Work .....	6
B. Design and Construction Responsibilities .....	6
C. Design Criteria .....	7
D. Design Review .....	7
E. Maintenance of Traffic .....	8
F. Ownership of Documents .....	9
G. Construction Criteria.....	9
H. Project Management .....	9
I. Control of the Work .....	10
J. Contract Deliverables.....	10
III. CONTRACT PRICE/CONTRACT PAYMENTS .....	11
A. Contract Price.....	11
B. Contract Price Adjustments .....	12
C. Contract Payments .....	14
D. Retainage.....	16
IV. CONTRACT TIME .....	17
A. Project Schedule.....	17
B. Contract Time Adjustments .....	19
C. Owner’s Right to Stop Work .....	20
D. Liquidated Damages .....	20
V. QUALITY ASSURANCE PROGRAM .....	20
A. CONTRACTOR’s Responsibilities .....	20
B. SCDOT Responsibilities.....	22
C. CONTRACTOR’s Obligation .....	23
VI. INSURANCE AND BONDING.....	23
A. Insurance .....	23
B. Bonding.....	26
VII. UTILITIES AND RAILROAD COORDINATION.....	27
VIII. RIGHT OF WAY ACQUISITION.....	30

Agreement for US 701 Bridge Replacements  
Georgetown & Horry Counties

A.	Right of Way Services .....	30
B.	Acquisition of Right-of-Way .....	33
IX.	PERMITS.....	34
X.	ENVIRONMENTAL COMPLIANCE.....	35
A.	Compliance with Environmental Commitments.....	35
B.	Preconstruction / Partnering Conference(s).....	36
C.	Protection of Archeological and Paleontological Remains and Materials.....	36
XI.	HAZARDOUS MATERIALS .....	36
XII.	DEMOLITION, REMOVAL & DISPOSAL OF STRUCTURES.....	38
XIII.	DIFFERING SITE CONDITIONS.....	38
XIV.	FORCE MAJEURE .....	39
XV.	WARRANTY .....	39
XVI.	INDEMNITY .....	40
XVII.	TERMINATION AND CANCELLATION .....	40
XVIII.	DISADVANTAGED BUSINESS ENTERPRISES .....	42
XIX.	ON-THE-JOB TRAINING REQUIREMENTS .....	43
XX.	RECORD RETENTION.....	43
XXI.	AS-BUILTS .....	43
XXII.	ESCROW PROPOSAL DOCUMENTS.....	45
A.	Scope and Purpose .....	45
B.	Proposal Documentation.....	45
C.	Submittal of Proposal Documentation .....	45
D.	Alternative Delivery Method .....	45
E.	Affidavit.....	46
F.	Verification .....	46
G.	Duration and Use .....	46
H.	Refusal or Failure to Provide Proposal Documentation .....	46
I.	Confidentiality of Bid Documentation.....	47
J.	Cost and Escrow Instructions.....	47
K.	Escrow Agreement.....	47
L.	Payment.....	47
XXIII.	DISPUTE RESOLUTION .....	47

XXIV. SCDOT’S AGENT ..... 48  
XXV. ASSIGNABILITY ..... 48  
XXVI. GENERAL PROVISIONS ..... 48  
CERTIFICATION OF CONTRACTOR ..... 51  
CERTIFICATION OF DEPARTMENT ..... 52

**LIST OF EXHIBITS**

1. Cost Proposal Bid Form
2. Schedule of Values
3. Scope of Work
4. Project Design Criteria
  - 4a. Roadway
  - 4b. Structures
  - 4c. Pavement
  - 4d. Traffic
    - Part 1 – Signing and Pavement Marking
    - Part 2 – Work Zone Traffic Control
  - 4e. Hydraulic/Hydrology
  - 4f. Geotechnical
5. Special Provisions
6. Supplemental Specifications and Forms
7. Federal Aid Project Supplemental Specifications
8. Environmental Information
9. Railroad Information
10. Escrow Proposal Documents

Agreement for US 701 Bridge Replacements  
Georgetown & Horry Counties

WHEREAS, the South Carolina Department of Transportation, as an agency of the State of South Carolina, wishes to improve the safety and operation of the state highway system by replacing three (3) bridges over Yauhannah Lake, Great Pee Dee River, and Great Pee Dee Overflow along US Route 701 in Georgetown and Horry Counties (hereinafter referred to as “the Project”); and

WHEREAS, the South Carolina Department of Transportation, as a servant of the people of the State of South Carolina, wishes to see this strategic project completed; and

WHEREAS, limitations imposed by traditional methods of designing, and constructing highways would mean that the Project could be completed only after an unacceptable delay; and

WHEREAS, the South Carolina Department of Transportation, working with the Federal Highway Administration (FHWA), has devised an innovative plan to allow the commencement and completion of the Project in a timely and cost-effective manner; and

WHEREAS, pursuant to Section 57-5-1625 SC Code of Law, the South Carolina Department of Transportation desires to award a highway construction contract using a Design / Build procedure; and

WHEREAS, after a competitive process, CONTRACTOR has been selected to participate in this venture by designing and building the Project; and

WHEREAS, the South Carolina Department of Transportation wishes to avail itself of and rely on CONTRACTOR’s expertise and proven track record in designing and constructing such projects, on time and within budget; and

WHEREAS, CONTRACTOR wishes to provide that expertise and to participate in this venture for the good of the people of the State of South Carolina;

NOW THEREFORE, this Agreement is executed and made, effective as of the Effective Date as defined herein, between the SOUTH CAROLINA DEPARTMENT OF TRANSPORTATION (“SCDOT”) and \_\_\_\_\_ (“CONTRACTOR”). In consideration of the covenants hereinafter set forth, the parties hereto mutually agree as follows:

## **I. CONTRACT DOCUMENTS**

The Contract shall be composed of this Agreement and all exhibits, SCDOT's Request for Proposals and all attachments, Request for Qualifications and all attachments, CONTRACTOR's Proposal and all attachments, and CONTRACTOR'S Qualifications and all attachments. In case of conflict, the order of precedence of the Contract documents shall be: (1) this Agreement; (2) Agreement Exhibits; (3) SCDOT Request for Proposals (RFP) document and Project Information; (4) CONTRACTOR's Proposal and attachments; and (5) SCDOT Request for Qualifications (RFQ) and CONTRACTOR's response. In the event of a conflict between the Project Criteria, Special Provisions and Supplemental Specifications identified in the Agreement Exhibits, the order of precedence shall be (1) the Project Criteria; (2) Special Provisions, and (3) Supplemental Specifications and Forms.

## **II. PROJECT SCOPE**

### **A. Scope of Work**

CONTRACTOR shall furnish all services, labor, materials, equipment, supplies, tools, transportation, and coordination required to perform all design, preliminary engineering, surveying, geotechnical services, scheduling, permitting, right of way services, procurement, construction, utility coordination, demolition, material disposal and any other services necessary to perform the Project as defined in the Project Scope of Work made a part hereof as **EXHIBIT 3**.

### **B. Design and Construction Responsibilities**

1. CONTRACTOR, consistent with applicable state licensing laws, shall provide, through qualified South Carolina licensed design professionals employed by CONTRACTOR or procured from qualified, independent South Carolina licensed design consultants, the necessary design work, including, but not limited to, surveys, right of way services, roadway design, maintenance of traffic, geotechnical exploration and design, hydraulic analyses, storm water management, erosion control, superstructure design, and foundation and substructure design including seismic analyses for the preparation of the required drawings, specifications and other design submittals to permit CONTRACTOR to complete the work in accordance with the Contract.

2. CONTRACTOR shall provide through itself or subcontractors the necessary supervision, labor, inspection, testing, material, equipment, machinery, temporary utilities and other temporary facilities to permit performance of all demolition, earthwork, drainage, foundation work, maintenance of traffic, roadway work, structural work, excavation, erosion and sediment control work, field layout work, construction management and inspection, and all other work necessary to complete construction of the Project in accordance with the Contract. CONTRACTOR shall perform all design and construction activities efficiently and with the requisite expertise, skill and competence to satisfy the requirements of the Contract. CONTRACTOR at all times shall exercise control over the means, methods, sequences and techniques of construction. CONTRACTOR's operations and construction methods shall comply

with all applicable federal, state and local regulations with regard to worker safety, protection and health and protection of the environment and applicable permit requirements.

3. CONTRACTOR shall design and construct the project in such a manner that the construction limits are contained within the approved environmental footprint to the extent possible. Where new right of way is required to construct the Project, the CONTRACTOR shall design and construct the Project so as to minimize the additional rights of way needed. The acquisition of rights of way, including both cost and services to acquire, shall be the responsibility of the CONTRACTOR and shall be done in accordance with Article VIII of this Agreement. CONTRACTOR shall furnish the SCDOT a copy of any agreements for the use of additional properties not acquired as right of way that are used in conjunction with the construction of this Project. CONTRACTOR shall abide by the provisions of all applicable environmental permits, any conditions of individual right of way agreements, and all environmental commitments. The CONTRACTOR shall sign the **Contractor Certification Form** ~~the NPDES co-permittee agreements and these agreements and this agreement~~ will be made part of the contract.

4. It shall be the responsibility of CONTRACTOR to determine and comply with all applicable federal, state, and local laws in connection with the services set forth in this Contract. This obligation shall include, but not be limited to, procurement of all permits and licenses not obtained by SCDOT provided, however, that with respect to any permit or licenses that must be obtained in the name of SCDOT, CONTRACTOR shall perform all functions within its power to obtain the permit, and SCDOT will fully cooperate in this effort and perform any functions that must be performed by SCDOT. CONTRACTOR shall be responsible for payment of all charges, fees, and taxes, and for providing all notices necessary and incident to the performance of the Project as of the Effective Date of this Agreement. The Contract Price shall include fees related to the above obligations and if any fees are waived by the regulatory or governmental entity, then the amount of the fee waived shall be deducted from the Contract Price.

### **C. Design Criteria**

It shall be the responsibility of CONTRACTOR to design all aspects of the Project in accordance with the contract documents. For the Project, CONTRACTOR shall provide a completed set of construction plans signed and sealed by a licensed professional engineer in South Carolina. CONTRACTOR shall be fully responsible for the accuracy of the design and compliance with specifications, standards and Project Criteria.

### **D. Design Review**

1. Within thirty (30) days prior to Notice to Proceed #1, CONTRACTOR, CONTRACTOR'S design consultant, subcontractors, suppliers and SCDOT shall meet to establish the sequencing procedures and schedule for submitting design plans for SCDOT's review. Within ten (10) days after this meeting, CONTRACTOR shall provide a Design Submittal Procedures and Schedule acceptable to SCDOT. CONTRACTOR, CONTRACTOR'S design consultant, subcontractors and suppliers shall not submit any design work until the Design Submittal Procedures and Schedule is approved by SCDOT. The Design Submittal Procedures

and Schedule will serve as the basis for reviewing the design and construction plans. The Design Submittal Procedures and Schedule shall be updated as requested by SCDOT

2. CONTRACTOR shall provide plans to SCDOT fifteen (15) SCDOT business days prior to commencement of the next phase of work, in formats designated by SCDOT, so that SCDOT will have an opportunity to review the plans prior to commencement of construction activities. The fifteen (15) business day review period will begin the first SCDOT business day after the submittal. If more than one package is submitted within a five day period, an additional five (5) business days per submittal package will be allowed for the reviews. Plans shall be submitted with all other reports and documents as defined in **EXHIBIT 4**. SCDOT will have the right, but not the obligation, to review and comment upon the plans. CONTRACTOR shall respond to SCDOT review comments in written form within five (5) business days. SCDOT will then status CONTRACTOR's comments within five (5) business days. SCDOT review comments shall be resolved prior to commencement of construction, demolition or disposal activities. This review and comment is fully discretionary, however no review or comment nor any failure to review or comment shall operate to absolve CONTRACTOR of its responsibility to design and build the Project in accordance with the contract or to shift responsibility to SCDOT.

#### **E. Maintenance of Traffic**

The SCDOT work zone mobility requirements found within the documents known as *Rule on Work Zone Safety and Mobility: The Policy for South Carolina Department of Transportation* and *Rule on Work Zone Safety and Mobility: Implementation, Maintenance, and Safety Guidelines* shall apply to this project. These requirements apply to the CONTRACTOR, all subcontractors, all SCDOT staff and designated representatives acting on behalf of the SCDOT performing duties with responsibilities relative to a work zone, including but not limited to planning, project development, design, construction, and maintenance.

The CONTRACTOR shall design, develop, implement and maintain a set of coordinated strategies to manage the work zone impacts of the project designated as the Transportation Management Plan. These strategies will include a Temporary Traffic Control plan, a Transportation Operations component, and a Public Information component. The Policy and the anticipated work zone impacts of the project shall determine the level of detail, content, and scope of the TMP. The primary component, the Temporary Traffic Control plan shall address traffic control and safety throughout and adjacent to the project site. A secondary component, the Transportation Operations plan, will address management of traffic operations in the project site and all adjacent areas impacted by the project. The final component, the Public Information plan, addresses communications with the public and entities impacted by the project. Ensure the Transportation Management Plan and its components comply with the requirements of Part 6 of the Manual on Uniform Traffic Control Devices (MUTCD) latest edition and SCDOT policies, standard specifications and all addendums to the standard specifications, the typical traffic control standard drawings for road construction, and procedures.



## **F. Ownership of Documents**

Drawings, specifications, test data, inspection reports, QC documents, daily diaries and any other documents, including those in electronic form, prepared by CONTRACTOR or CONTRACTOR's consultants are "Project Documents". CONTRACTOR and CONTRACTOR's consultants shall be the owner of the Project Documents. Upon the Effective Date of this Agreement, CONTRACTOR grants SCDOT a nonexclusive license to reproduce the Project Documents for the purposes of, but not limited to, promoting, using, maintaining, upgrading, or adding to the Project. Upon completion of the Project or upon default by CONTRACTOR, CONTRACTOR shall provide copies of all Project Documents to SCDOT in the format designated by SCDOT.

## **G. Construction Criteria**

CONTRACTOR shall construct the Project in accordance with all applicable Federal, State, and local statutes and regulations. All construction shall be performed in accordance with the following criteria, which are incorporated herein by reference and made a part hereof. The construction criteria are intended to be complementary and to describe and provide for a complete work. Where the following construction criteria conflict, the order of precedence shall be as listed below:

1. **EXHIBIT 4** – Project Criteria
2. **EXHIBIT 5** – Special Provisions
3. SCDOT Standard Drawings, effective as of the release of the Final RFP
4. SCDOT Supplemental Specifications and Supplemental Technical Specifications, effective as of the release of the Final RFP
5. SCDOT Standard Specifications for Highway Construction, effective as of the release of the Final RFP
6. SCDOT Construction Manual, effective as of the release of the Final RFP
7. SCDOT Approval Sheets, Material Acceptance Policies and New Products Evaluation Summary (available on SCDOT internet website)

## **H. Project Management**

1. CONTRACTOR shall be responsible for ensuring that the Project is constructed in conformance with the Contract, all referenced documents and specifications, and applicable laws and regulations.

2. CONTRACTOR shall provide project management services sufficient to supervise the activities of his own personnel and subcontractors. CONTRACTOR shall provide a sufficient number of persons on site, to the satisfaction of SCDOT, to provide for the construction management of the Project.

3. SCDOT will provide representatives assigned to the Project to monitor the construction and provide necessary coordination between SCDOT and CONTRACTOR. All costs for salary and equipment to maintain SCDOT employees will be provided by SCDOT at no expense to CONTRACTOR. SCDOT and Federal Highway Administration (FHWA) representatives will have full and complete access to the Project, the work in progress, the “Daily Diaries”, and to other technical documents and project records associated with design, construction, demolition, material disposal, materials, quality control, materials installation, and testing. SCDOT representatives will receive reasonable notice of and have the opportunity to participate in any meetings that may be held concerning the Project or the relationship between CONTRACTOR and their consultants and subcontractors when such meetings are associated with technical matters, progress, or quality of the Project. As used in this paragraph, “notice” shall require actual written notice to SCDOT’s Agent.

**I. Control of the Work**

1. CONTRACTOR shall determine the appropriate means, methods and scheduling necessary to complete the work timely and in accordance with all construction requirements. SCDOT and FHWA will have the right to review and inspect the work at any time.

2. If, at any time, SCDOT observes or has actual notice of any fault or defect in CONTRACTOR’s performance of this Agreement, SCDOT will give CONTRACTOR prompt written notice reasonably detailing the nature of the fault or defect. SCDOT is not required to discover or to accept defective or faulty work. SCDOT’s right to have defective or faulty work promptly corrected shall not be waived by any action of SCDOT.

3. SCDOT will have the authority to suspend the work, wholly or in part, for such periods, as SCDOT may deem necessary, due to CONTRACTOR’s failure to meet the requirements of the Contract in the performance of the work.

4. No inspection, acceptance, payment, partial waiver, or any other action on the part of SCDOT will operate as a waiver of any portion of this Agreement or of any power reserved herein or any right to damages or other relief, including any warranty rights, except insofar as expressly waived by SCDOT in writing. SCDOT will not be precluded or estopped by anything contained herein from recovering from CONTRACTOR any overpayment as may be made to CONTRACTOR.

**J. Contract Deliverables**

CONTRACTOR shall submit deliverables including, but not limited to, the following as set forth in the CONTRACT.

1. Contract Deliverable Matrix
2. Schedule of Values (**EXHIBIT 2**)
3. Plans - Article II.D.2

4. Erosion Control Plan (for entire project, in order to submit Notice of Intent (NOI))
5. Storm Water Pollutant Prevention Plan and Spill Prevention Plan
6. Transportation Management Plan
7. Crane Safety Plan
8. QC Plan
9. Community and Public Relations Plan
10. Drainage Notebooks for the Project in accordance with SCDOT's Requirements for Hydraulic Design
11. CPM Schedule
12. EEO, DBE, and OJT Requirements, as specified in **EXHIBIT 7**
13. Right-of-Way documents per Article VIII
14. Shop Plans and working drawings
15. Preliminary & Final Geotechnical Reports
16. All final electronic design files for the Project, as specified in **EXHIBIT 4**
17. Escrow Proposal Documents
18. CONTRACTOR's Materials Certification
19. As-Built Plans
20. RR Agreement
21. HAZMAT surveys for bridges
22. Clearing and Grubbing Plan
23. Utility Coordination Reports and Utility Agreements
24. Right of Way Plats and Monuments (per Preconstruction Advisory Memorandum #8)

### **III. CONTRACT PRICE/CONTRACT PAYMENTS**

#### **A. Contract Price**

The "Contract Price" shall be \$ \_\_\_\_\_. In consideration for the Contract Price, CONTRACTOR shall perform all of its responsibilities under the Contract. The Contract Price shall include all work identified in the Project Scope of Work - **EXHIBIT 3**, and as identified in the Cost Proposal Bid Form - **EXHIBIT 1**.

**B. Contract Price Adjustments**

1. Allowable adjustments

The Contract Price may be adjusted to reflect the direct costs, plus an additional amount not to exceed 10% of the direct costs for the combined total of reasonable overhead\* and profit, associated with any of the following:

a) Amount added or deducted as the result of a “Change” or “Construction Change Directive”.

b) Differing site condition as defined in Article XIII.

c) Intentional or bad faith acts or omissions by SCDOT that unreasonably interfere with CONTRACTOR’s performance and cause delay of work on the critical path of the Project.

d) Changes in legal requirements or regulations that are effective subsequent to the date of this Agreement.

e) Discovery of hazardous materials as set forth in Article XI.

f) Discovery of archeological or paleontological sites not previously identified as noted in Article X.

g) Premium right-of-way costs and second appraisals as set forth in Article VIII. Only the actual premium right-of-way and actual second appraisal cost will be reimbursed. No additional amount for overhead and profit will be considered for this item.

\* Overhead: The operating expense of a business exclusive of direct cost labor and material.

Other than as provided above, the Contract Price shall not be increased for contract time adjustments or delay damages. Contract Price adjustments shall be documented by Supplemental Agreement signed by both parties and shall be reflected immediately in the Schedule of Values. No claim by the CONTRACTOR for an adjustment hereunder shall be allowed if notice is not given prior to final payment under this Agreement.

2. Changes

a) A “Change” shall be any deviation or variation from the Project Scope or the Project Criteria. No Change shall be implemented without the express written approval of SCDOT. A “Change” may be an “Additive Change” or a “Deductive Change”.

b) SCDOT may initiate a change by advising CONTRACTOR in writing of the change. As soon thereafter as practicable, CONTRACTOR shall prepare and forward to SCDOT an estimate of cost or savings, and the impact to the schedule resulting from the change. SCDOT will advise CONTRACTOR in writing of its approval or disapproval of the change. If SCDOT approves the change, CONTRACTOR shall perform the Services as changed.

3. Construction Change Directive

A Construction Change Directive is a written order from SCDOT directing a change prior to agreement with CONTRACTOR on adjustment, if any, to the Contract Price or Contract Time. If a price for the work cannot be agreed upon, CONTRACTOR shall perform the work under Force Account Procedures as outlined in Section 109.5 of SCDOT’s Standard Specifications.

4. Direct Costs

For the purpose of a Contract Price Adjustment, “Direct Costs” shall be defined as:

a) Costs of labor, including social security, old age and unemployment insurance, fringe benefits required by agreement or custom, and workers’ compensation insurance;

b) Costs of materials, supplies, and equipment, including cost of transportation, whether incorporated or consumed;

c) Actual costs of machinery and equipment owned by CONTRACTOR or any affiliated or related entity exclusive of hand tools;

d) Actual costs paid for rental of machinery and equipment exclusive of hand tools;

e) Costs of premiums for all bonds and insurance, permit fees, and sales, use or similar taxes;

f) Additional costs of supervision and field office personnel directly attributable to the change or event; and

g) Costs incurred or fees paid for design work related to the change or event.

## C. Contract Payments

### 1. Schedule of Values

Prior to execution of this Agreement, CONTRACTOR shall provide a Schedule of Values acceptable to SCDOT and work may not start until the Schedule of Values is approved by SCDOT. The Schedule of Values will serve as the basis for cost loading of the CPM Schedule. The CPM schedule shall include sufficient information to provide for monetary and quantitative tracking of the work by SCDOT. Updates to the cost-loaded CPM schedule will serve as the basis for progress payments requested by and made to CONTRACTOR. If the Contract Price is adjusted, CONTRACTOR shall revise its Schedule of Values and the CPM Schedule to reflect the adjustment in the Contract Price. The revised Schedule of Values must be approved by SCDOT prior to the time for the subsequent request for a progress payment otherwise no progress payments will be made. The Schedule of Values shall be incorporated herein as **EXHIBIT 2**. The Schedule of Values should include Lump Sum items that will serve as measurement and payment for any item referred to in this Contract as a “contract unit bid price” item.

### 2. Mobilization

Mobilization shall not exceed 5% of the ~~construction~~ Total Contract Cost as shown in the Schedule of Values. Mobilization will be paid in two (2) equal installments. The first will be paid in the progress payment immediately following NTP #1 and, the second, immediately following NTP #2. ~~at the start of construction.~~

### 3. Periodic Progress Payment Applications

No application for payment of the Contract Price shall be submitted until SCDOT gives a notice to proceed. Applications for payment of the Contract Price may be submitted once a month. Each application for payment of the Contract Price shall set forth, in accordance with the Schedule of Values and the cost-loaded CPM schedule, the percentage of all items comprising the work completed since CONTRACTOR's immediately prior request for payment. The application for payment of the Contract Price may also request payment for equipment and materials not yet incorporated into the Project, provided that (i) SCDOT is satisfied that the equipment and materials are suitably stored at either the Project or another acceptable location, (ii) the equipment and materials are protected by suitable insurance and (iii) upon payment, SCDOT will receive title to the equipment and materials free and clear of all liens and encumbrances.

### 4. Periodic Progress Payments

SCDOT will review each application for payment. Upon approval by SCDOT of an application for payment, SCDOT will pay CONTRACTOR the undisputed percentage for the Project completed during the period covered by the application for payment. SCDOT will make each payment within twenty-one (21) days

of the receipt of the corresponding Application for Payment. In the event of a dispute over the quality of work or percentage of the Project completed, SCDOT's decision is controlling and final. Payment by SCDOT will not preclude or estop SCDOT from correcting any measurement, estimate, or certificate regarding the percentage completion of the Project, and future payments may be adjusted accordingly.

5. Prompt Payment of Subcontractors

a) Subject to the provisions on retainage provided in Paragraph (b) below, when a subcontractor has satisfactorily performed a work item of the subcontract, CONTRACTOR must pay the subcontractor for the work item within seven (7) calendar days of CONTRACTOR's receipt of payment from SCDOT. A subcontractor shall be considered to have "satisfactorily performed a work item of the subcontract" when SCDOT pays CONTRACTOR for that work item.

b) CONTRACTOR may withhold as retainage up to five (5%) percent of a subcontractor's payment until satisfactory completion of all work items of the subcontract. "Satisfactory completion of all work items of the subcontract" shall mean when SCDOT pays CONTRACTOR for the last work item of the subcontract. CONTRACTOR must release to the subcontractor any retainage withheld within seven (7) calendar days from the date CONTRACTOR receives payment from SCDOT for the last work item of the subcontract. For further information regarding Retainage, see Article III, paragraph D.

c) With each progress payment application, CONTRACTOR shall certify to SCDOT that the payment application is complete and that all subcontractors have been paid for work covered by previous applications.

d) Failure to comply with any of the above provisions shall result in one or more of the following sanctions: (1) no further payments to CONTRACTOR unless and until compliance is achieved; (2) CONTRACTOR being placed in default; and/or (3) CONTRACTOR being declared delinquent, such delinquency being subject to procedures and penalties provided in 108.8 of the Standard Specifications.

6. Withholding of Payment

SCDOT may withhold all or part of any payment under the Contract because for any of the reasons listed below. Any funds withheld will be released upon CONTRACTOR satisfactorily remedying the defect, fault, or failure and will be included in the next regularly schedule pay estimate. Payment will be subject to retainage if applicable.

a) Defective work not remedied. Any such withholding, however, shall not exceed two times the reasonable cost of remedying the defective work. Defective work shall be defined as work or material not conforming to the requirements of the Contract.

- b) Reasonable evidence that the Work will not be Substantially Complete within the Contract Time as adjusted and that the unpaid balance of the Contract Price will not be adequate to cover Liquidated Damages for the actual unexcused delay;
- c) Failure to comply with the prompt payment provision of this Contract;
- d) Any fines or other charges to SCDOT due to CONTRACTOR's failure to comply with permit requirements or other regulations;
- e) Notice of cancellation of insurance;
- f) Failure to submit updated and approved CPM or Schedule of Values;
- g) Violation of QC plan requirements;
- h) Failure to follow specifications or procedures required by the Contract;
- i) Failure to comply with DBE, On-The-Job training, or Pre-Employment Training provisions;
- j) Failure to provide adequate work zone traffic control;
- k) Failure to provide adequate sediment and erosion control; or,
- l) Violation of any contract provisions.

**D. Retainage**

Provided the Project is proceeding satisfactorily, SCDOT will not withhold retainage. However, if at any time SCDOT determines that CONTRACTOR fails to meet contract terms or the Project is not proceeding satisfactorily, SCDOT may retain up to 10% of the Contract Price as retainage. If the reason for SCDOT's withholding of retainage is attributable to a subcontractor's failure to perform, CONTRACTOR may withhold up to 10% of the subcontractor's payment until all work of the subcontract work is satisfactorily performed. If it decides to withhold retainage, SCDOT will not withhold more than 20% of any single payment application. SCDOT will have sole authority to determine the amount (not exceeding 10%) and necessity of retainage.



## IV. CONTRACT TIME

### A. Project Schedule

1. Time for Completion of Project. The Project shall be Substantially Complete within \_\_\_\_\_ calendar days from Notice to Proceed #2. Time is of the essence. SCDOT will establish two Notices to Proceed for the Project. Notice to Proceed #1 shall be no later than 45 days from the effective date of the Agreement and will initiate all preconstruction and permitting activities in order to successfully secure all permits for the Project. The duration for these preconstruction and permitting activities has been established as 365 calendar days. SCDOT will only consider time extensions beyond this 365 calendar day timeframe subject to the provisions in Article IX of the Agreement. Notice to Proceed #2 will initiate construction once the 404 permit secured. Notice to Proceed #2 shall be issued no later than 45 days from the effective date of the 404 permit or 410 calendar days from the **Notice to Proceed #1 first notice to proceed**, whichever comes first. The PROPOSER must identify the time required for the construction time of the Project on the Cost Proposal Bid Form. Final Completion shall be reached as defined in paragraph 5 below.

Contract Time shall be the number of calendar days from Notice to Proceed #1 to Notice to Proceed #2, not to exceed 410 calendar days, plus construction time as defined on the Cost Proposal Bid Form in Exhibit 1 and the time from Substantial Work Completion to Final Completion, not to exceed 180 days.

2. Substantial Work Completion. The Project shall be considered substantially complete when it is serviceable to the public, all lanes and ramps are open, and all work is completed except for “Project Close-out Activities”, “Project Close-out Activities” are defined as punch list items, site clean-up, demobilization, and final Project documentation, including but not limited to as-built plans.

3. Critical Path Method Schedule: CONTRACTOR shall prepare and maintain a schedule for the Project using the Critical Path Method of scheduling (hereinafter called “CPM Schedule”). Prepare the schedule in accordance with this agreement and the SCDOT Supplemental Specifications (**EXHIBIT 6**) with the following exceptions:

a) Submit to the SCDOT the initial baseline CPM schedule within 30 days from the Effective Date of this Agreement. No contract payment will be made to Contractor and no construction work may begin until a CPM baseline schedule is received and accepted by SCDOT. Update the baseline CPM schedule for monetary and quantitative tracking purposes as Released for Construction plans are developed.

b) Cost-load the CPM schedule using the expenses identified in the schedule of values. Use the schedule of values to establish Expense Categories and assign to the correct activities.

c) Include submittal activities. Allow duration for these activities to include SCDOT review periods.

d) Reuse of deleted activity ID's from schedule update to schedule update is not allowed.

e) Failure to include any element of work or any activity including but not limited to utility relocation, right of way acquisition, and permitting will not relieve the CONTRACTOR from completing all work within the Contract Time at no additional time or cost to the SCDOT, notwithstanding the acceptance of the schedule by SCDOT.

f) Develop project specific calendars reflecting all seasonal restrictions included in this Agreement and non-work days. Address durations for weather within activity duration, not within the calendar.

g) Use only a Work Breakdown Structure (WBS) to organize schedule activities. At a minimum, breakout the design and construction phases. These two breakouts should have the same parent within the structure.

h) Submit monthly updates no later than 15 days following the most recent estimate period end date, whether or not an estimate was generated. Set the data date the same as the most recent estimate period end date.

i) If SCDOT determines any schedule submission is deficient, it will be returned to the CONTRACTOR. A corrected schedule shall be provided within 7 calendar days from the SCDOT's transmittal date.

j) The schedule may indicate an early completion date. However, SCDOT will not be liable in any way for CONTRACTOR's failure to complete the Project prior to the specified Contract Time. Any additional costs, including extended overhead incurred between CONTRACTOR's scheduled completion date and the Contract Time, shall be the responsibility of the CONTRACTOR.

k) The schedule may include constraints to indicate the early completion of portions of the work. SCDOT will remove these constraints when determining the critical path of the schedule.

l) Include in each narrative a detailed listing of crews utilized on activities and their responsibilities. In lieu of this, the Contractor may request to submit a Resource Loaded CPM schedule.

#### 4. Progress Review Meetings.

a) Review Meetings shall be held between CONTRACTOR and SCDOT at least every 2 weeks. Periodic construction meetings shall be held by CONTRACTOR with its consultants and subcontractors to coordinate the work, update the schedule, provide information and resolve potential conflicts.

b) SCDOT and CONTRACTOR will hold a regular CPM Progress Meeting at which all principal parties are expected to attend. These meetings will be held the week before the application for payment is due so that job progress will coincide with the payment application. At this meeting, CONTRACTOR

shall provide the most recent schedule with notations showing actual start dates, actual finish dates, and activity progress. If the schedule provided indicates an actual or potential delay to the completion of the Contract, CONTRACTOR shall provide a narrative identifying the problems, causes, the activities affected and describing the means and methods available to complete the Project by the Contract Time.

5. Final Completion. When CONTRACTOR believes that all elements of its work on the Project, including all of the requirements of the Contract, have been completed, it shall notify SCDOT in writing. Final Completion shall be achieved within 180 calendar days of Substantial Work Completion as defined in this Agreement. Within thirty (30) days thereafter, SCDOT will acknowledge project completion or will advise CONTRACTOR in writing of any aspect of the Contract or the Project Scope that is incomplete or unsatisfactory. CONTRACTOR shall complete all corrective action within thirty (30) days after written notification of incomplete or unsatisfactory items. CONTRACTOR will notify SCDOT in writing upon completion of necessary corrective action. SCDOT will verify satisfactory completion of the corrective action in writing to CONTRACTOR. Upon verification, the Project shall be deemed to have achieved Final Completion.

6. Inspection/Acceptance; No Waiver. No inspection, acceptance, payment, partial waiver, or any other action on the part of SCDOT will operate as a waiver of any portion of this Agreement or of any power reserved herein or any right to damages or other relief, including any warranty rights, except insofar as expressly waived by SCDOT in writing. SCDOT will not be precluded or estopped by anything contained herein from recovering from CONTRACTOR any overpayment as may be made to CONTRACTOR.

## **B. Contract Time Adjustments**

The Contract Time may be extended if there is a delay to the critical path of the Project caused by an event listed below. All requests for time extensions shall be made in writing to SCDOT within 20 days of the event causing the delay. All time extensions must be approved in writing by SCDOT. Time extensions may be allowed for the following events that affect the critical path:

1. Force Majeure as that term is defined in this Agreement in Article XIV;
2. Changes or construction change directives;
3. Differing site conditions as defined under Article XIII;
4. Injunctions, lawsuits, or other efforts by individuals or groups that hinder, delay, or halt the progress of the Project, provided that such efforts are not premised on alleged wrongs or violations by CONTRACTOR or its subcontractors;
5. Interference with or delay of work on the critical path of the Project by SCDOT; however, CONTRACTOR shall not be entitled to a time

extension if SCDOT's actions are necessitated by CONTRACTOR's actions, omissions, failure to perform quality work, or failure to comply with contract requirements;

6. Changes in the legal requirements or regulations which are effective subsequent to the date of this Agreement;
7. Discovery of hazardous materials as set forth in Article XI; or,
8. Discovery of archeological or paleontological remains not previously identified as set forth in Article X.

### **C. Owner's Right to Stop Work**

SCDOT will have the authority to suspend the work, wholly or in part, for such periods, as SCDOT may deem necessary, due to CONTRACTOR's failure to meet the requirements of the Contract in the performance of the work. Such suspension of the work shall not constitute grounds for claims for damages, time extensions, or extra compensation.

### **D. Liquidated Damages**

CONTRACTOR shall pay liquidated damages to SCDOT in the amount of Four Thousand Dollars (\$4,000.00) for each day for which construction is not substantially complete, as defined in Article IV.

CONTRACTOR shall pay liquidated damages to SCDOT in the amount of One Thousand Five Hundred Dollars (\$1,500.00) for each day that Final Completion, as defined in Article IV is not achieved.

The parties acknowledge, recognize and agree that because of the unique nature of the Project, it is difficult or impossible to determine with precision the amount of damages that would or might be incurred by SCDOT as a result of the CONTRACTOR's failure to complete the Project as specified in the Contract. Therefore, any sums payable under this provision are in the nature of liquidated damages, and not a penalty, and are fair and reasonable and such payment represent a reasonable estimate of fair compensation for the losses that may reasonably be anticipated from such failure. Notwithstanding the above, liquidated damages are not intended to excuse the CONTRACTOR from liability for any other breach of its obligations under the Contract.

## **V. QUALITY ASSURANCE PROGRAM**

### **A. CONTRACTOR's Responsibilities**

CONTRACTOR shall be responsible for the QUALITY CONTROL Portion of the Program to include the items listed below. Work shall not commence until CONTRACTOR has met these requirements.

1. Quality Control Plan: CONTRACTOR shall submit a Quality Control Plan that outlines how CONTRACTOR shall assure that the materials and work are in compliance with the drawings, plans, standard specifications, contract special provisions, SCDOT Construction Manual, Inspection Training Manuals, RFP and all attachments. The Quality Control Plan shall also include the specific portions of the Transportation Management Plan that address the work item. The initial plan shall be submitted to SCDOT for review and approval at least five (5) business days prior to any design or plan submittal or the beginning of any construction activity. The plan shall be updated as necessary prior to the start of any specific construction operation. The plan shall include a list of SCDOT certified SCDOT personnel responsible for management and quality control of the Project, and define the authority of each individual. The plan shall also include how CONTRACTOR will monitor quality and deal with failing materials. CONTRACTOR shall include an estimated summary of quantities to SCDOT for the purposes of meeting the minimum sampling and testing requirements in accordance with the SCDOT Construction Manual.

2. Personnel: CONTRACTOR shall provide a sufficient number of SCDOT certified personnel to adequately control the work of the Project. Any personnel required to obtain samples or conduct material testing shall be certified or adequately trained and qualified as determined by SCDOT. Training, qualification, and/or certification shall include classroom training, written testing, documented demonstration of proper inspection, sampling and testing procedures, pre-employment training and an on-the-job training period. CONTRACTOR shall provide SCDOT with copies of each individual's training, qualifications, and/or certifications, in resume form, as required, for review and approval by SCDOT. Approved CONTRACTOR QC personnel shall be on the job at all times that the CONTRACTOR is on-site actively involved in work with no other assigned project responsibilities.

3. CONTRACTOR Testing: CONTRACTOR is required to conduct asphalt sampling and testing in accordance with QC/QA special provisions and supplemental specifications for asphalt included in EXHIBITS 5 and 6 and the SCDOT Supplemental Technical Specifications. CONTRACTOR may elect to conduct other sampling and testing for its own benefit. The cost of these activities will be borne by CONTRACTOR. Additionally, CONTRACTOR is responsible for dynamic and static load testing of drilled shafts and piles in accordance with the requirements of EXHIBITS 4 and 5.

4. Testing Laboratories: All testing laboratories used on the Project must be AASHTO certified and approved by SCDOT thirty (30) days prior to beginning the portion of work for which the laboratory will be performing the testing.

5. Mix Designs: Copies of all initial hot-mix asphalt mix designs and Portland Cement Concrete mix designs, along with supporting data, shall be submitted to SCDOT for review at least five (5) business days prior to use. All hot-mix asphalt mix designs will be prepared by personnel certified in Mix Design Methods. Portland Cement Concrete mix designs will be prepared by a certified concrete technician or a Professional Engineer. The Portland Cement Concrete mix proportions given in the specifications are to be followed. CONTRACTOR shall design the mix to obtain the strength and

water/cement ratios given in the specifications, and shall provide workability, air content, gradation and suitable set times as set forth in the Standard Specifications. The SCDOT will be notified of any revisions to CONTRACTOR's mix design. Copies of such revisions will be sent to SCDOT for review at least ten (10) business days prior to use.

6. Materials Certifications: CONTRACTOR shall submit all material certifications for approval by SCDOT prior to the CONTRACTOR incorporating the material and applying for payment for work in which the material was incorporated. Upon Completion of the project, CONTRACTOR shall submit to SCDOT a letter of certification stating that, based upon an analysis of all materials test results, all materials incorporated into the Project were found to be in substantial conformance with the requirements of the plans and specifications. A list of any exceptions and all failing test results will be provided, along with a record of disposition of the material represented by these tests.

## **B. SCDOT Responsibilities**

SCDOT will be responsible for the QUALITY ACCEPTANCE portion of the program to include: conducting inspections, acceptance testing, independent assurance testing and final project material certification.

1. Acceptance Testing: SCDOT personnel assigned to the Project, or qualified personnel retained by SCDOT, will conduct sampling and testing, separate from CONTRACTOR's testing, at the frequencies set forth in SCDOT's construction manual. This testing will be used by SCDOT to determine the acceptability of the materials. All sampling and testing will be in accordance with existing AASHTO, ASTM, or SC test methods used by SCDOT. The cost of these activities will be borne by SCDOT. CONTRACTOR is required to coordinate its activities closely with SCDOT to allow the necessary acceptance testing to be conducted prior to proceeding to the next operation. The disposition of failing materials must be approved by SCDOT.

2. Independent Assurance Testing: SCDOT will be responsible for conducting Independent Assurance Testing. Personnel performing these tests will be SCDOT employees or qualified persons retained by SCDOT. Persons performing these tests will not be involved in Acceptance Testing. This testing will be used to ensure that proper sampling and testing procedures are being followed, and that testing equipment is functioning properly. This testing will consist of observing sampling and testing by both SCDOT personnel performing Acceptance Testing and CONTRACTOR personnel performing Quality Control Testing, as well as taking split samples for the purposes of comparison testing. Independent Assurance Testing will be at an approximate frequency of one-tenth of the Acceptance Testing frequency. Independent Assurance test results will not be used for acceptance. The cost of these activities will be borne by SCDOT.

3. Materials Certification: SCDOT will be responsible for preparing the Materials Certification as required by the FHWA on federally funded projects.

**C. CONTRACTOR's Obligation**

SCDOT's testing in no way relieves CONTRACTOR of its obligation to comply with the Contract requirements. All materials incorporated into the Project must meet or exceed contract requirements and specifications. Further, any testing by SCDOT will not relieve CONTRACTOR of any of its warranty obligations.

**VI. INSURANCE AND BONDING**

**A. Insurance**

1. CONTRACTOR shall purchase and maintain in a company or companies that maintain an A.M. Best rating of not less than A-VII with coverage forms acceptable to SCDOT. The insurance described below shall be maintained uninterrupted for the duration of the Project, including warranty periods, and shall protect CONTRACTOR from claims set forth below which may arise out of or result from CONTRACTOR's operations under the Contract, whether such operations be performed by CONTRACTOR or by any subcontractor or by anyone directly or indirectly employed by any of them or by anyone for whose acts any of them may be liable:

- a) Claims under workers' or workmen's compensation, disability benefit and other similar employee benefit acts;
- b) Claims for damages because of bodily injury, occupational sickness or disease, or death of CONTRACTOR's employees;
- c) Claims for damages because of bodily injury, sickness or disease, or death of any person other than CONTRACTOR's employees;
- d) Claims for damages insured by usual personal injury liability coverage which are sustained (1) by any person as a result of an offense directly or indirectly related to the employment of such person by CONTRACTOR, or (2) by any other person;
- e) Claims for damages, other than to the work itself, because of injury to or destruction of tangible property, including loss of use resulting therefrom;
- f) Claims for damages because of bodily injury or death of any person or property damage arising out of the ownership, maintenance or use of any motor vehicle.
- g) Claims involving contractual liability insurance applicable to the Contractor's obligations under the indemnity provisions of this contract.

2. The minimum limits of liability for the following types of insurance are required, except where greater limits are required by statute:

a) Workers' Compensation, including: Worker's Compensation Insurance/Employer's Liability

State Statutory limits	Employer's Liability
	\$100,000 per accident
	\$500,000 per disease
	\$100,000 each employee

- b) Commercial General Liability \$1,000,000 per occurrence  
\$2,000,000 aggregate

Commercial General Liability insurance shall be written on ISO occurrence form CG 00 01 (or substitute for providing equivalent coverage) and shall cover liability arising from premises, operations, independent contractors, products-completed operations, contractual liability and personal injury and advertising injury. The policy shall contain the per project endorsement.

- c) Business Automobile Liability \$1,000,000 per occurrence

This policy shall cover Any Auto, including Owned, Hired and Non-owned Automobiles. Business auto coverage shall be written on ISO form CA 00 01, CA 00 05, CA 00 12, CA 00 20, or a substitute form providing equivalent liability coverage.

- d) Umbrella Liability Coverage \$10,000,000 per occurrence  
\$20,000,000 aggregate

The general aggregate limit shall apply separately to the Project

3. Certificates of Insurance acceptable to SCDOT will be provided to SCDOT prior to execution of this Agreement. These certificates shall name SCDOT as an additional insured under the Commercial General Liability (CGL) arising out of both the on-going operations and completed operations of CONTRACTOR. Such additional insured coverage shall be endorsed to Contractor's CGL policy using ISO Additional Insured Endorsement form CG 2010 (10/01) and CG 2037 (10/01) or a substitute providing equivalent coverage, and included under the commercial umbrella. CONTRACTOR shall maintain continual additional insured status for SCDOT under the products-completed operations coverage for the time period required to satisfy the statute of limitation for South Carolina. CONTRACTOR shall also name SCDOT as additional insured under Business Automobile and Umbrella policies and reference the Project to which the certificate applies. The policies must contain a provision that coverage afforded will not be canceled or reduced until at least 30 days prior written notice has



been given to SCDOT and that the policies cannot be cancelled for non-payment of premiums until at least 10 days prior written notice has been provided to SCDOT. Send Notice of Cancellations to Director of Construction Room 330, PO Box 191, Columbia, SC 29202. Make certain that the policies are endorsed to reflect this requirement. Verification of additional insured status shall be furnished to SCDOT by including a copy of the endorsements with the Certificate of Insurance. This insurance, including insurance provided under the commercial umbrella shall apply as primary and noncontributory insurance with respect to any other insurance or self-insurance programs, including any deductibles, afforded to, or maintained by, SCDOT. CONTRACTOR'S deductibles shall not exceed \$250,000 without written consent of the SCDOT and that the certificates show the deductible amounts.

4. Limits shown in this provision are minimum acceptable limits and in no way limit available coverage to the additional insured. CONTRACTOR's CGL and commercial umbrella policies shall contain no provision providing that the limits available to an additional insured are less than the limits available to the CONTRACTOR. SCDOT shall be given all the same rights and insurance coverage as CONTRACTOR. In the event that any insurer issues a reservation of rights for SCDOT as an additional insured, SCDOT shall be entitled to employ independent counsel, of its choice, at CONTRACTOR's expense.

5. There shall be no endorsements or modifications of the CGL limiting the scope of coverage for liability arising from explosion, collapse, underground property damage or work performed by contractors on behalf of SCDOT.

6. Hazardous waste. If the CONTRACTOR is required to remove and haul any hazardous waste from the Project, or if the Project involves such similar environmental exposure, pollution liability coverage equivalent to that provided under the ISO Pollution Liability – Broadened Coverage for Covered Autos Endorsement (CA 99 48) shall be provided, and the Motor Carrier Act Endorsement (MCS 90) shall be attached. Limits of pollution liability shall be not less than \$1,000,000 per occurrence. Coverage shall apply on an “occurrence form” basis, shall cover at a minimum bodily injury, property damage, defense costs and clean-up costs and be extended to include non-owned disposal sites and transportation coverage. This insurance shall remain in effect after acceptance by Owner for the time period required to satisfy the statute of limitations in South Carolina. However, if coverage is written on a “claims made form”, then the Contractor's Pollution Liability coverage shall include a retroactive date that precedes the commencement of work under this Agreement. Such coverage shall apply as primary and non-contributory insurance with respect to any other insurance or self-insurance programs, including any deductibles, afforded to, or maintained by SCDOT.

7. Waiver of Subrogation. CONTRACTOR shall waive its rights against SCDOT, other additional insured parties, and their respective agents, officers, directors and employees for recovery of damages, or any other claims, to the extent these damages are covered by the CGL, business auto, workers compensation and employer's liability or commercial umbrella maintained pursuant to this section of the Agreement.

8. CONTRACTOR shall at the time of execution of this Agreement, obtain Errors and Omissions insurance for their Professional Liability, for all claims arising from the performance of professional services on the Project. The insurance coverage shall be for not less than Three Million Dollars (\$3,000,000) per claim and in the aggregate. The coverage shall be continued for three (3) years after the date of Final Completion of the Project. Evidence of such insurance shall be provided to SCDOT at the time of the execution of the Agreement.

9. CONTRACTOR shall provide “Builders Risk Insurance” acceptable to the SCDOT in the amount of the Contract Price protecting the respective interests of SCDOT and CONTRACTOR and covering physical loss or damage to the work during construction of the Project. The certificate of insurance shall be provided to the SCDOT at the time of execution of this Agreement. The policy shall name the SCDOT as an additional insured and shall reference the Project by name. The certificate shall also state that the coverage will not be cancelled or reduced without 30 days prior written notice to the SCDOT.

10. After completion of the work, CONTRACTOR shall maintain CGL and commercial umbrella coverage to include liability coverage for damage to insured’s completed work equivalent to that provided under ISO CG 00 01 for three (3) years or for the statute of limitations period for damages, whichever is greater.

11. By execution of the contract, the CONTRACTOR accepts the responsibility to provide the liability insurance policies and endorsements as specified herein. Failure of SCDOT to identify a deficiency in the Certificate of Insurance submitted by the CONTRACTOR's insurance agent as evidence of the specified insurance or to request other evidence of full compliance with the liability insurance specified shall not be construed as a waiver of the CONTRACTOR's obligation to provide and maintain the required insurance for the duration of the contract.

## **B. Bonding**

1. CONTRACTOR shall at the time of the execution of this Agreement, provide SCDOT the following bonds:

a) A Performance and Indemnity Bond from a surety or sureties satisfactory to SCDOT. The amount of bond shall be equal to the Contract Price.

b) A Payment Bond from a surety or sureties satisfactory to SCDOT. The amount of bond shall be equal to the Contract Price.

These bonds shall be in accordance with the requirements of S.C. Code Ann. §57-5-1660, (1976 as amended) and S.C. Code Ann. §29-6-250 (2000). Bonds shall be issued by a surety company licensed in the State of South Carolina with an “A” minimum rating of performance as stated in the most current publication of “A.M. Best Key Rating Guide, Property Liability” and signed by the surety's agency or attorney-in-fact. Surety

must be listed on the current U.S. Department of the Treasury Financial Management Service list of approved bonding companies as approved for an amount equal to or greater than the amount for which it obligates itself in the Bond. If surety qualifies by virtue of its Best's listing, the amount of the Bond may not exceed ten percent of policyholders' surplus as shown in the latest A.M. Best's Key Rating Guide.

2. CONTRACTOR shall also provide a warranty bond, acceptable to SCDOT, in the amount of Three Million Dollars (\$3,000,000) to cover the warranty obligations of the contract.

## **VII. UTILITIES AND RAILROAD COORDINATION**

**A.** As part of the Project Scope, CONTRACTOR shall have the responsibility of coordinating the Project construction and demolition activities with all utilities that may be affected. CONTRACTOR shall be responsible for the cost of utility coordination as defined herein. If applicable, all temporary relocation costs as well as any other conflict avoidance measures shall be the responsibility of the CONTRACTOR. For those utilities that have prior rights SCDOT will be responsible for permanent relocation costs as defined by the Federal code. For those utilities where the CONTRACTOR determines that the SCDOT has prior rights, CONTRACTOR may exercise these rights and require the utility company to bear the costs of relocation. If there is a dispute over prior rights, SCDOT shall be responsible for resolving the dispute. SCDOT shall have final determination of the utility's prior rights.

**B.** For those utilities requiring relocation, CONTRACTOR shall conform with SCDOT's "A Policy for Accommodating Utilities on Highway Rights of Way", the applicable State laws, and the Code of Federal Regulations, Title 23, Chapter 1, Subchapter G, part 645, subparts A and B.

**C.** The resolution of any conflicts between utility companies and the construction of the Project shall be the responsibility of CONTRACTOR. No additional compensation (time or dollars) will be allowed for any delays, inconveniences or damage sustained by CONTRACTOR or its subcontractors due to interference from utilities or the operation of relocating utilities.

**D.** CONTRACTOR shall meet with the Department's Utilities Office within seven (7) days of the Notice to Proceed #1 to gain a full understanding of what is required with each utility submittal.

**E.** CONTRACTOR shall design the Project to avoid conflicts with utilities where possible, and minimize impacts where conflicts cannot be avoided. If there is a dispute between the CONTRACTOR and SCDOT as to whether a utility relocation is required, SCDOT shall have the final determination. Additional utility relocations desired by the CONTRACTOR for but not limited to construction staging, access or convenience, shall be the sole responsibility of CONTRACTOR and all associated costs shall be borne by the CONTRACTOR.

**F.** CONTRACTOR shall initiate early coordination with all utilities and provide the utility companies with design plans for their use in developing Relocation Sketches as soon as the plans have reached a level of completeness adequate to allow the companies to fully

understand the Project impacts. If a party other than the utility company prepares Relocation Sketches, there shall be a concurrence box on the plans where the utility company signs and accepts the Relocation Sketches as shown.

**G.** CONTRACTOR shall be responsible for collecting and submitting to SCDOT the following from each utility company that is located within the project limits:

1. **Relocation Sketches** including letter of “no cost” where the company does not have a prior right;
2. **Utility Agreements** including documentation of prior rights, cost estimate and relocation plans where the company has a prior right; and/or
3. **Letters of “no conflict”** where the company’s facilities will not be impacted by the Project. Include location sketches on SCDOT plans confirming and certifying that facilities are not in conflict.
4. **Encroachment Permits** for all relocations regardless of prior rights.

**H.** CONTRACTOR shall assemble the information included in the Utility Agreements and Relocation Sketches in a final and complete form and in such a manner that the Department may approve the submittals with minimal review. CONTRACTOR shall ensure that there are no conflicts with the proposed highway improvements, or between each of the utility company’s relocation plans. CONTRACTOR may not authorize the utility companies to begin their relocation work until authorized in writing by SCDOT. Any early authorization by CONTRACTOR shall be at the CONTRACTOR’s risk.

**I.** At the time that CONTRACTOR notifies SCDOT that CONTRACTOR deems the Project to have reached Final Completion, CONTRACTOR shall certify to SCDOT that all utilities have been identified and that those utilities with prior rights or other claims related to relocation or coordination with the Project have been relocated or their claims otherwise satisfied or will be satisfied by CONTRACTOR.

**J.** CONTRACTOR shall accurately show the final location of all utilities on the as-built drawings for the Project.

**In the event railroad property is impacted by this project, provisions K through S shall apply:**

**K.** Under the direction of and in coordination with SCDOT, the CONTRACTOR shall be responsible for all coordination with the involved Railroad Companies, including but not limited to, sending plans, meetings, correspondence, phone calls, writing/reviewing agreements, and etc. as may be necessary to secure the applicable executed railroad agreements, needed for the construction of the project, between the SCDOT and all involved railroad companies. All correspondence related to railroad agreements or conditions shall include the railroad file number and railroad milepost information. The CONTRACTOR shall be responsible for the cost of railroad coordination as defined herein.

**L.** SCDOT will submit for approval, all required railroad agreements necessary for the Preliminary Engineering and Construction of the project. Upon approval, the SCDOT will submit the agreement to the Railroad Company for execution. The CONTRACTOR shall be responsible for assisting SCDOT in the development of the railroad agreement by providing requested information.

**M.** The CONTRACTOR shall be responsible for all costs to the Railroad Company or Companies for services provided by the Railroad or the Railroad's Agent, as detailed in the executed Railroad Agreement between the SCDOT and the Railroad. This includes all expenses such as railroad flagging operations. The CONTRACTOR shall be responsible for all other costs associated with designing and constructing the project as described in the executed Railroad Agreement between the SCDOT and the Railroad Company. The CONTRACTOR shall include all costs associated with these requirements in the final bid price. Once a contract is executed, SCDOT shall administer invoicing for costs to the Railroad Company or Companies. Monies will be deducted from the CONTRACTOR's progress payments.

**N.** All design and construction activities in, adjacent to, over or under the railroad shall comply with all applicable Federal and State laws and standards, all terms identified in the Special Provisions for Protection of Railway Interests, and all terms of the final agreement executed with the Railroad Company.

**O.** The CONTRACTOR will be required to meet the Railroad's Insurance Requirements as specified in the Special Provisions for Protection of Railway Interests.

**P.** The CONTRACTOR shall attend a mandatory meeting with the SCDOT's Utilities Office and Railroad Projects Office within thirty (30) days of the **Notice to Proceed #1**. The CONTRACTOR will be required to use the SCDOT approved agreement language and procedures, that will be provided in this meeting.

**Q.** SCDOT has negotiated language for the PE and Construction Agreements (see Exhibit 9). CONTRACTOR shall provide project specific information to SCDOT for inclusion into the agreements. The CONTRACTOR shall anticipate and include in the proposed schedule a minimum 90-day approval time-frame for all railroad agreements. However, SCDOT will not be held responsible for delays caused by negotiations with the railroad company.

**R.** CONTRACTOR shall anticipate the need for a separate right-of-entry agreement between the CONTRACTOR and Railroad for surveys, borings, etc. The required PE

Agreement, between SCDOT and Railroad, must be executed before Railroad will review or comment on any design questions or submittals from the CONTRACTOR. The Construction Agreement, between SCDOT and Railroad, must be executed before any construction activities can begin.

S. CONTRACTOR is advised the all utility relocations required within railroad right-of-way will require separate agreements between the affected utility company and the Railroad.

## **VIII. RIGHT OF WAY ACQUISITION**

### **A. Right of Way Services**

CONTRACTOR, acting as an agent on behalf of the State of South Carolina, shall provide right-of-way services for the Project. CONTRACTOR shall use firm(s) from the SCDOT's current "on-call" list for right of way consultants, as listed in Attachment B, to provide right of way services. Right-of-way services shall include appraisal, appraisal review, negotiation, acquisition, and relocation assistance services. CONTRACTOR shall be responsible for all costs related to these right-of-way services. CONTRACTOR will provide expert testimony and SCDOT will provide legal services necessary for any cases that are to be resolved by trial. Experts are defined as engineering and appraisal witnesses. SCDOT will retain final authority for approving just compensation, relocation benefits and settlements. SCDOT will designate a hearing officer to hear any Relocation Assistance Appeals. SCDOT agrees to assist with any out of state relocation by persons displaced within the rights of way by arranging with such other state(s) for verification of the relocation assistance claim. CONTRACTOR shall carry out the responsibilities as follows:

1. Acquire property in accordance with all Federal and State laws and regulations, including but not limited to the Uniform Relocation and Real Property Acquisition Act of 1970, as amended (the "Uniform Act") and the South Carolina Eminent Domain Procedure Act ("The Act"). The acquisition of property shall follow the guidelines as established by the Department and other State and Federal guidelines. CONTRACTOR shall not be entitled to an increase in the Contract Price for acquisition of borrow sources.

2. Submit procedures for handling right-of-way acquisitions and relocations to the SCDOT for approval prior to commencing right-of-way activities. These procedures are to show CONTRACTOR'S method including the appropriate steps and workflow required for appraisal, acquisition, and relocation. CONTRACTOR shall be granted the authority for administrative settlements by the SCDOT's Right-of-Way Office upon review and approval of the Right-of-Way Procedures. These procedures should also include an appropriate time allowance for SCDOT to establish just compensation, approve relocation benefits, and approve administration and legal settlements. A SCDOT Representative will be available to make timely decisions concerning establishing just compensation, approving relocation benefits, and approving administrative settlements on behalf of SCDOT. The SCDOT Representative is

committed to issuing decisions on approval requests within three (3) business days. The commitment is based on the procedure providing a reasonable and orderly workflow and the work being provided to the SCDOT Representative as completed.

3. Utilize SCDOT's right-of-way project tracking system and provide an electronic status update a minimum of twice per month or upon request by SCDOT's representative.

4. Submit a right-of-way quality control plan to the SCDOT for review prior to commencing right-of-way activities. SCDOT standard forms and documents will be used to the extent possible.

5. Provide a toll free telephone number for landowners and displaced persons to call.

6. Provide a current title certificate by a licensed South Carolina attorney for each parcel as of the date of closing or the date of filing of the Condemnation Notice.

7. Prepare appraisals in accordance with the Department's Appraisal Manual. Appraisals shall be prepared by appraisers who are on the SCDOT approved list of active fee appraisers.

8. Provide appraisal reviews complying with technical review guidelines of SCDOT Appraisal Manual and make a recommendation of just compensation. The reviewer shall be from the SCDOT's approved reviewer list.

9. Make direct payments of benefits to property owners for negotiated settlements, relocation benefits and payments to be deposited with the court and notify SCDOT monthly of payments made.

10. Prepare, obtain execution of, and record documents conveying title to such properties to SCDOT with Register of Deeds, and deliver all executed and recorded general warranty deeds to SCDOT. For all property purchased in conjunction with the Project, title will be acquired in fee simple (except that SCDOT may in its sole discretion direct the acquisition of a right-of-way easement or permissions, in lieu of fee simple title, with respect to any portion of the Rights of Way) and shall be conveyed to "The South Carolina Department of Transportation" by general warranty deed, free and clear of all liens and encumbrances except permitted encumbrances.

11. Because these acquisitions are being made as agent on behalf of the State of South Carolina, SCDOT shall make the ultimate determination in each case as to whether settlement is appropriate or whether the filing of a condemnation action is necessary, taking into consideration the recommendations of the CONTRACTOR. When SCDOT authorizes the filing of a condemnation, CONTRACTOR shall prepare a Notice of Condemnation in the name of SCDOT, and submit it to SCDOT for SCDOT to file

and serve appropriate condemnation documents and pleadings, and request priority status pursuant to S.C. Code Ann. Section 28-2-310(1976, as amended).

12. SCDOT shall prosecute condemnation proceedings to final judgment pursuant to the requirements of the South Carolina Eminent Domain Procedures Act. The procedure shall be by way of trial as provided by Section 28-2-240 of "The Act". SCDOT shall be responsible for obtaining legal representation and CONTRACTOR will be responsible for providing expert witnesses necessary for condemnation actions. All settlements of condemnation cases shall be at SCDOT's sole discretion.

13. CONTRACTOR will be responsible for all contacts with landowners for rights-of-way or construction items and shall provide the following:

- a) All Notices of Condemnation, issued pursuant to the authority granted, all titles of real estate and all right of way easements, permissions, or right-of easements, recorded with the Office of the Register of Deeds or the Clerk of Court for the county or counties in which properties acquired through condemnation are located;
- b) A right-of-way agent's worksheet, or documents substantially in the format of SCDOT Form No. 809, for each tract.

14. CONTRACTOR shall provide a right-of-way certification and SCDOT shall approve that certification prior to CONTRACTOR entering the property. Only in exceptional circumstances will a certification be approved based on a right of entry. Certification may be on a tract-by-tract basis.

15. CONTRACTOR shall exercise care in its operations when working in proximity to adjacent developed properties, properties not yet acquired, and residences or businesses that are to be relocated. CONTRACTOR shall submit a plan to the SCDOT's right-of-way representative for approval to:

- a) Establish a clear zone adjacent to properties occupied by persons to be displaced in which construction equipment may not be operated or parked,
- b) Establish a clear zone for construction for properties occupied by persons to be displaced to prevent undue impacts or hardships,
- c) Establish a method of protecting equipment from vandalism or unauthorized use,
- d) Locate brush piles and mulching/grinding operations more than 500 feet from an occupied business or residence, or as required by South Carolina Department of Health and Environmental Control burning regulations,



- e) Provide reasonable and safe access to residences or businesses that are to be displaced until such time as the property is vacant, and
- f) Observe the property rights of landowners of adjacent and/or yet to be acquired properties.

16. CONTRACTOR shall use reasonable care in determining whether there is reason to believe that property to be acquired for rights-of-way may contain concealed or hidden wastes or other materials or hazards requiring remedial action or treatment. When there is reason to believe that such materials may be present, CONTRACTOR shall take steps consistent with customary SCDOT practices to investigate. SCDOT shall be notified of the presence of such materials before an offer is made to acquire the property.

17. During the acquisition process and for a period of three years after final payment is made to CONTRACTOR for any phase of the work, all project documents and records not previously delivered to SCDOT, including but not limited to design and engineering costs, construction costs, costs of acquisition of rights-of-way, and all documents and records necessary to determine compliance with the laws relating to the acquisition of rights-of-way and the costs of relocation of utilities, shall be maintained and made available to SCDOT for inspection or audit.

## **B. Acquisition of Right-of-Way**

1. The CONTRACTOR is responsible for verification of all information necessary for acquisition of the Right-of-Way and is responsible for all costs, excluding premium cost as defined below, associated with the purchase of the Right-of-Way. The CONTRACTOR shall acquire the property as an agent on behalf of the State of South Carolina.

2. Acquisition of any additional area desired by the CONTRACTOR necessary to complete the project, shall comply with this Article of the Contract, with the exception of cost allocation.

3. All costs associated with the acquisition of any additional area are the sole responsibility of the CONTRACTOR, including premium right-of-way costs. CONTRACTOR shall abide by the provisions of all applicable environmental permits, any conditions of individual right of way agreements, and all environmental commitments. Any necessary permit modifications are the responsibility of the CONTRACTOR.

4. Acquisition of any additional area desired by the CONTRACTOR for, but not limited to, construction staging, access or borrow pits shall be the sole responsibility of CONTRACTOR, and any title or interest shall be secured in the name of the CONTRACTOR. CONTRACTOR shall provide SCDOT the location and documentation for these additional areas. CONTRACTOR shall furnish SCDOT a copy of any agreements, whether for purchase or lease, for the use of additional properties in

conjunction with the construction of the Project. CONTRACTOR shall abide by the provisions of all applicable environmental permits, any conditions of individual right of way agreements, and all environmental commitments. Any necessary permit modifications are the responsibility of the CONTRACTOR. CONTRACTOR is responsible for all costs associated with these additional areas, including premium right-of-way costs. If additional right-of-way is necessary beyond what has been evaluated in the NEPA documentation, CONTRACTOR shall be responsible for any re-evaluation of the approved Environmental Documents.

5. ROW acquisition costs shall be defined as amounts paid for: (1) direct payments for ownership or other property rights, and (2) direct payments for eligible relocation expenses as provided for under the Uniform Act less Premium ROW acquisition costs.

6. Premium ROW acquisition costs shall be the amount a jury award or a settlement that exceeds "Just compensation." "Just compensation" shall be defined as the value SCDOT approves for a parcel after the following procedure: CONTRACTOR shall submit its recommendation for just compensation based on appraisals and appraisal reviews which support the recommendation. If SCDOT approves CONTRACTOR'S recommendations, that value becomes just compensation. If SCDOT does not approve the recommendation, CONTRACTOR or SCDOT shall obtain another appraisal using an appraiser from the SCDOT's approved list and submit this appraisal to SCDOT. SCDOT shall be responsible for the cost of the second appraisal. SCDOT shall assign a value to the parcel which shall be deemed just compensation supported by the appraisals for the parcel.

7. CONTRACTOR shall be responsible for right-of-way service costs and right-of-way acquisition costs.

8. SCDOT shall be responsible for premium right-of-way costs except for those additional areas explained above.

9. Upon final completion of the project, if any right-of-way condemnation actions are still pending, CONTRACTOR shall provide reasonable and adequate security to cover its contractual obligation relating to right-of-way acquisition.

## **IX. PERMITS**

**A.** All permits necessary for completion of this project shall be procured by the CONTRACTOR. The CONTRACTOR shall comply with all local, state, and federal permitting requirements. Regarding any permit or license that must be obtained in the name of SCDOT, the CONTRACTOR shall perform all functions within its power to obtain the permit or license, and SCDOT shall fully cooperate in this effort and perform any functions that must be performed by SCDOT. The CONTRACTOR shall submit permit applications to SCDOT. SCDOT will submit the permit application to the appropriate permitting agency indicating that CONTRACTOR is acting as an agent for SCDOT. If said regulatory agencies fail to issue

permits in a timely manner, SCDOT may, on an individual basis, consider a time extension for permit approval delays when CONTRACTOR can demonstrate that the application was submitted in a timely manner, all reasonable efforts have been made to expedite the permit approval, and that the delay has a direct impact on the Critical Path. CONTRACTOR shall not be entitled to additional compensation for delays in permit approval.

**B.** All necessary permit modifications shall be the CONTRACTOR's responsibility. All work associated with permit modifications as a result of changes proposed by CONTRACTOR shall be CONTRACTOR's responsibility. See Article II.B.4 regarding deductions for waived fees.

## **X. ENVIRONMENTAL COMPLIANCE**

### **A. Compliance with Environmental Commitments**

CONTRACTOR shall comply with all Environmental commitments and requirements including, but not limited to, the following:

1. Compliance with the provisions of all environmental permits applicable to the Project. A copy of the environmental document is included in **Attachment B**. Environmental Commitments are included in **Exhibit 8**.
2. Compliance with those stipulations and conditions under which SCDOT received approval of the Environmental Document(s) and any modifications resulting from a re-evaluation of the Document(s). If the CONTRACTOR elects to construct the Project in a manner that is not consistent with the assumptions in the SCDOT prepared environmental documents, the CONTRACTOR will be responsible for revising the environmental documents and provide any additional studies that may be required. All revisions will require SCDOT and FHWA approval prior to any right of way acquisition or construction activity;
3. Compliance with applicable laws and regulations relating to potential or actual hazardous materials that may be encountered in the course of carrying out this Agreement;
4. Carrying out all necessary social, economic, and environmental studies required by regulatory authorities in the course of construction;
5. Preparation of any permits required by federal, state, or local laws or regulations; The CONTRACTOR is responsible for any mitigation required by permits; and
6. The resolution of any deviations from the contract documents, drawings or other information included in the environmental permits that would violate the intent or spirit of the permits. Any proposed changes within the permitted areas would need to be coordinated with SCDOT's Environmental Management Office.

**B. Preconstruction / Partnering Conference(s)**

CONTRACTOR shall conduct one (or more, if appropriate) pre-construction / partnering conference(s) prior to any construction activity to discuss environmental and permitting issues, which conference shall include all subcontractors, and, to the extent feasible, representatives from the U.S. Army Corps of Engineers, the S.C. Department of Health and Environmental Control Water Quality Division, the Federal Highway Administration, CONTRACTOR, and SCDOT.

**C. Protection of Archeological and Paleontological Remains and Materials**

1. When archeological or paleontological remains are uncovered, CONTRACTOR shall immediately halt operations in the area of the discovery and notify SCDOT.

2. Archeological remains consist of any materials made or altered by man which remains from past historic or prehistoric times (i.e. older than 50 years) Examples include old pottery fragments, metal, wood, arrowheads, stone implements or tools, human burials, historic docks, structures or not recent (i.e. older than 100 years) vessel ruins. Paleontological remains consist of old animal remains, original or fossilized, such as teeth, tusks, bone, or entire skeletons.

3. SCDOT will have the authority to suspend the work for the purpose of preserving, documenting, and recovering the remains and materials of archeological and paleontological importance for the State. CONTRACTOR shall carry out all instructions of SCDOT for the protection of archeological or paleontological remains, including steps to protect the site from vandalism and unauthorized investigations, from accidental damage and from dangers such as heavy rainfall or runoff.

4. CONTRACTOR's Contract Time and or Contract Price shall be adjusted to the extent CONTRACTOR's cost and /or time of performance have been adversely impacted by the presence of archeological or paleontological remains.

**XI. HAZARDOUS MATERIALS**

**A.** For the existing US 701 Bridges, the CONTRACTOR is referred to Attachment B – Project Information Package for information regarding Hazardous Materials Surveys. The CONTRACTOR shall anticipate that the structural steel components on the existing US 701 Bridges contain lead-based paints. The CONTRACTOR shall remove and dispose of the structural steel components containing lead-based paints in compliance with all applicable Federal (EPA, OSHA & DOT) and State requirements for lead as waste, lead in air, lead in water, lead in soil, and worker health and safety. The cost of the removal and disposal of components containing lead-based paints on the existing US 701 Bridges shall be included in the Contract Price. A copy of the lead and asbestos report and notification of demolition or renovation forms must be submitted to the South Carolina Department of Health and Environmental Control at least ten (10) working days prior to demolition of the existing structure. Furthermore, the CONTRACTOR shall be responsible for handling, storage,

remediation, or disposal of any materials, wastes, substances and chemicals deemed to be hazardous under applicable state or federal law, (hereinafter "Hazardous Conditions") encountered at the Site which were identified in the Phase I ESA provided in **ATTACHMENT B**. The CONTRACTOR is responsible for obtaining all required permits to proceed with the work.

In addition, the CONTRACTOR shall perform hazardous material surveys on the abandoned portions of US 701 identified in Exhibit 3, including foundations and obstructions. The cost of the surveys shall be included in the Contract Price. As a result of these surveys, the CONTRACTOR shall be responsible for developing a remedial strategy to address any Hazardous materials, wastes, substances or chemicals on the Project. Further remedial actions shall be as stipulated in the remaining sections of the Article. ~~CONTRACTOR is responsible for obtaining any necessary survey(s) to determine the extent of and develop a remedial strategy of Hazardous materials, wastes, substances or chemicals on the Project. The cost of the surveys shall be included in the Contract Price. The CONTRACTOR shall anticipate that the structural steel components contain lead-based paints. The CONTRACTOR shall remove and dispose of the structural steel components containing lead-based paints in compliance with all applicable Federal (EPA, OSHA & DOT) and State requirements for lead as waste, lead in air, lead in water, lead in soil, and worker health and safety. The cost the removal and disposal of components containing lead-based paints shall be included in the Contract Price. The CONTRACTOR is required to perform asbestos inspections on the existing structures. A copy of the lead and asbestos report and a notification of demolition or renovation forms must be submitted to the South Carolina Department of Health and Environmental Control at least ten (10) working days prior to demolition of an existing structure. The CONTRACTOR is responsible for obtaining all required permits to proceed with the work. The CONTRACTOR is responsible for required containment and disposal of the asbestos. The cost of removal and disposal of components containing asbestos shall be included in the Contract Price.~~

**B.** Except as noted in paragraph "A" above, CONTRACTOR is not responsible for handling, storage, remediation, or disposal of any materials, wastes, substances and chemicals deemed to be hazardous under applicable state or federal law, (hereinafter "Hazardous Conditions") encountered at the Site which were not introduced to the site by CONTRACTOR or any of its agents. Upon encountering any Hazardous Conditions, CONTRACTOR shall stop Work immediately in the affected area and duly notify SCDOT and, if required by state or federal law, all government or quasi-government entities with jurisdiction over the Project or site.

**C.** Upon receiving notice of the presence of Hazardous Conditions, SCDOT will take necessary measures required to ensure that the Hazardous Conditions are remediated or rendered harmless. Such necessary measures will include SCDOT either (i) retaining qualified independent firm or (ii) negotiating a construction change directive with CONTRACTOR.

**D.** CONTRACTOR shall resume Work at the affected area of the Project only after written notice from SCDOT that the (i) Hazardous Conditions have been removed or rendered harmless and (ii) all necessary approvals have been obtained from all government and quasi-government entities having jurisdiction over the Project.

**E.** CONTRACTOR's Contract Price and/or Contract Time shall be adjusted to the extent CONTRACTOR's cost and/or time of performance has been adversely impacted by the presence of Hazardous Conditions.

**F.** SCDOT is not responsible for Hazardous Conditions actually brought to the Project by CONTRACTOR, CONTRACTOR's design consultants, subcontractors and suppliers or anyone for whose acts they may be or are liable. SCDOT is not responsible for negligent or willful acts by CONTRACTOR, CONTRACTOR's design consultants, subcontractors and suppliers or anyone for whose acts they may be or are liable relating to Hazardous Conditions found at the site. CONTRACTOR shall indemnify, defend and hold harmless SCDOT and SCDOT's officers, directors, employees and agents from and against all claims, losses, damages, liabilities and expenses, including attorney's fees and expenses arising out of or resulting solely from those Hazardous Conditions actually brought to the Project or negligent or willful acts relating to Hazardous Conditions, or both by CONTRACTOR, CONTRACTOR's design consultants, subcontractors and suppliers or anyone for whose acts they may be or are liable.

## **XII. DEMOLITION, REMOVAL & DISPOSAL OF STRUCTURES**

CONTRACTOR shall be responsible for the demolition, removal and disposal of all structures and their appurtenances within SCDOT Right of Way necessary for the completion of the Project, to include those portions which may extend outside the right of way, but were purchased as a part of the acquisition process. Structures shall include the bridges identified in the scope of work and all buildings acquired for the Project. All necessary permitting shall comply with Articles II.B.4 and IX of the Contract. Handling and disposal of Hazardous Conditions shall be in accordance with Article XI of the Contract. Before demolition of the structures, the CONTRACTOR shall complete and submit a Notification of Demolition and Renovation form to the South Carolina Department of Health and Environmental Control.

## **XIII. DIFFERING SITE CONDITIONS**

**A.** "Differing Site Conditions" are defined as concealed or latent physical conditions at the Site that (i) materially differ from the conditions reasonably assumed to exist based on the information contained in the RFP, this Agreement and its Exhibits; or (ii) are of an unusual nature, differing materially from the conditions ordinarily encountered and generally recognized as inherent in the work. For this project, subsurface/geotechnical conditions WILL NOT be considered as a Differing Site Condition.

**B.** Upon encountering a Differing Site Condition, CONTRACTOR shall provide prompt written notice to SCDOT of such condition, which notice shall not be later than twenty (20) days after such condition has been encountered. CONTRACTOR shall provide such notice before the Differing Site Condition has been substantially disturbed or altered and before any work is performed.

**C.** Upon written notification, SCDOT will investigate the conditions and if it is determined that the conditions differ materially and cause an increase or decrease in the cost or

time required for performance of the work, the Contract will be adjusted. No contract adjustment that results in a benefit to CONTRACTOR will be allowed unless CONTRACTOR has provided the required written notice.

#### **XIV. FORCE MAJEURE**

Delays or failures of performance shall not constitute breach of the Agreement if and to the extent such delays or failures of performance are caused by severe and not reasonably foreseeable occurrences beyond the control of SCDOT or CONTRACTOR, including, but not limited to: Acts of God or the public enemy; expropriation or confiscation of facilities; compliance with any order or request of any governmental authority other than SCDOT or a party in privity with it; a change in law directly and substantially affecting performance of the Project; Acts of War; rebellion or sabotage or damages resulting there from; fires, floods, explosions, or extraordinary accidents; riots or strikes or other concerted acts of workman, whether direct or indirect, or any similar causes, which are not within the control of SCDOT or CONTRACTOR respectively, and which by the exercise of reasonable diligence, SCDOT or CONTRACTOR are unable to prevent. Any expense attributable to such occurrence shall not entitle CONTRACTOR to an adjustment in the Contract Price. Any critical path delay attributable to such an occurrence shall be added to the Contract Time.

#### **XV. WARRANTY**

**A.** CONTRACTOR warrants that it will perform all services in accordance with the standards of care and diligence normally practiced by recognized engineering and construction firms in performing services and obligations of a similar nature. CONTRACTOR warrants that all materials and equipment furnished shall be of good quality and new unless otherwise authorized by SCDOT and that the construction shall conform to the Contract requirements. CONTRACTOR agrees to promptly correct, at its own expense, defects or deficiencies in materials and workmanship that appear prior to and during a period of three (3) years after Final Completion of the Project. This shall include all plant-produced materials (i.e. asphalt, concrete, etc.). CONTRACTOR shall not be responsible for damages caused by SCDOT's failure to provide timely notification of potentially damaged or defective work of which SCDOT had actual knowledge. CONTRACTOR shall properly perform, at the written request of SCDOT made at any time within the warranty period after Final Completion of the Project as defined in Article IV.A.5, all steps necessary to satisfy the foregoing warranty and correct any element of the Project or the services that is defective or does not reflect such standards of care and diligence. The cost of such corrective services shall be CONTRACTOR's responsibility.

**B.** CONTRACTOR further warrants the performance of all bridge components on all structures for three (3) years from Final Completion of the Project. If a component fails to perform properly for any reason, including but not limited to normal wear and tear, the CONTRACTOR shall replace the failed component at no cost to SCDOT.

**C.** The warranty periods begin at Final Completion of the Project. CONTRACTOR shall immediately abate any warranty deficiency that poses an unsafe condition to the public;

otherwise deficiencies shall be corrected no later than 30 days from the determination of corrective action. In the event CONTRACTOR, after notice, fails to immediately abate the deficiency or fails to make correction within the prescribed thirty (30) days, SCDOT may have the deficiency corrected. All costs associated with such correction by SCDOT shall be the responsibility of the CONTRACTOR and his Surety. With respect to any component that is repaired or replaced pursuant to this warranty, the warranty period of that component shall be the longer of one year from repair or replacement of the component or the remainder of the original warranty period.

**D.** CONTRACTOR shall take all steps necessary to transfer to SCDOT any manufacturer's or other third-party's warranties of any materials or other services used in the construction of the Project.

## **XVI. INDEMNITY**

**A.** CONTRACTOR shall indemnify, defend and hold SCDOT harmless from any and all claims, liabilities and causes of action for any fines or penalties imposed on SCDOT by any state or federal agency because of violation by CONTRACTOR or any of its subcontractors of any state or federal law or regulation.

**B.** CONTRACTOR shall indemnify, defend and hold SCDOT harmless from any and all claims, liabilities and causes of action arising out of or resulting from, in whole or in part, the negligence or recklessness of CONTRACTOR or its agents, consultants and/or subcontractors.

## **XVII. TERMINATION AND CANCELLATION**

### **A.** Termination for Default

1. CONTRACTOR shall be in default of the Contract if it:

- a) Fails to supply a sufficient number of properly skilled workmen, tools, materials and equipment to assure the prompt completion of the work;
- b) Fails to perform work in accordance with contract requirements and/or refuses to remove or replace rejected materials or unacceptable work;
- c) Discontinues the prosecution of the work;
- d) Fails to resume work that has been discontinued within a reasonable time after notice to do so;
- e) Becomes insolvent or is declared bankrupt or commits any act of bankruptcy or insolvency;



- f) Allows any final judgment to remain unsatisfied for a period of 15 days;
- g) Makes an assignment for the benefit of creditors;
- h) Fails to maintain the Project schedule;
- i) Commits a substantial breach of the Contract; or
- j) For any other cause whatsoever, fails to carry on the work in an acceptable manner.

2. If CONTRACTOR does not commence work to cure the default within 15 days after receipt of written notice from SCDOT and thereafter diligently prosecute work to completion within a reasonable time as determined by SCDOT, then SCDOT will have full power and authority to terminate CONTRACTOR for default and shall provide written notification of the termination to CONTRACTOR and Surety.

3. Upon termination for default, Surety will have the right to complete the contract and shall be given thirty (30) days, or longer in SCDOT's discretion, in which to resume the work. This procedure shall not in any way serve to extend the contract time. All charges incident to negotiation with the Surety and arranging for work to be resumed, including attorney's fees, shall be charged against CONTRACTOR or Surety as part of the cost of the work.

4. If Surety refuses to complete the work or fails to take over the work promptly as provided by this Agreement, then SCDOT may appropriate or use any or all materials and equipment on the job site as may be suitable and acceptable and may enter into an agreement for the completion of the Contract. All costs and charges incurred by SCDOT together with the cost of completing the work under the Contract will be deducted from any monies due or which may become due CONTRACTOR. If such expense exceeds the sum which would have been payable under the Contract, CONTRACTOR and Surety shall be liable and shall pay to SCDOT the amount of such excess.

5. Upon termination for default, all Project Documents, as defined in Article II.E, shall be surrendered forthwith by CONTRACTOR to SCDOT. SCDOT will be authorized to use the Project documents for the sole purpose of promoting, completing, using, maintaining, upgrading or adding to the Project. This authorization includes allowing design professionals to make changes, corrections, or additions to the Project documents for these purposes.

6. If, after termination, it is determined that the Contractor was not in default, or that the default was excusable, the rights and obligations of the parties shall be the same as if the termination had been issued for the convenience of the State.

**B. Termination for Convenience**

1. SCDOT reserves the right to cancel the Work upon ten (10) days written notice to CONTRACTOR. Should the Work be so canceled by SCDOT for convenience, CONTRACTOR shall be paid for the value of the Work, based upon the Schedule of Values, performed to the date of cancellation and demobilization together with any cancellation charges by vendors and subcontractors. CONTRACTOR shall also be entitled to the cost of securing the work, provided such cost is approved by SCDOT. In no event, however, shall the total payment to CONTRACTOR pursuant to such a cancellation exceed the Contract Price.

2. Termination of all or a portion of the Contract shall not relieve CONTRACTOR of any responsibility it would otherwise have for the work completed, or for any claims arising from that work.

3. Upon such termination, all Project Documents, as defined in Article II.E, shall be surrendered forthwith by CONTRACTOR to SCDOT. SCDOT will be authorized to use the Project documents for the sole purpose of promoting, completing, using, maintaining, upgrading or adding to the Project. This authorization includes allowing design professionals to make changes, corrections, or additions to the Project documents for these purposes.

## **XVIII. DISADVANTAGED BUSINESS ENTERPRISES**

**A. DBE Goal** - The DBE goal on this Project is eight percent (8.0 %) of the Contract Price. CONTRACTOR shall comply with the requirements of the SCDOT DBE – Design Build Special Provision, attached hereto in Exhibit 5, and the SCDOT DBE Supplemental Specification, attached hereto in Exhibit 7. CONTRACTOR is required to submit a DBE Utilization Plan within thirty (30) calendar days of execution of the Agreement in accordance with the requirements of the DBE Special Provision, which shall include, but not be limited to, the designation of a DBE liaison officer who will be assigned the responsibility of administering and promoting an active and inclusive DBE Program as required by 49 CFR Part 26, DBE Special Provision and DBE Supplemental Specification. CONTRACTOR's DBE liaison shall provide SCDOT with updated DBE Committal Sheets, signed quotes, and executed subcontracts in accordance with the approved DBE Utilization Plan. The Final Committal Sheet, signed quotes and executed subcontracts shall be submitted to the SCDOT within 180 calendar days from the Notice to Proceed #1.

**B. Copies of DBE Contracts** - CONTRACTOR shall provide SCDOT with copies of executed DBE contracts, including the name of the DBE firm, the name of the subcontractor, if any, for whom the DBE will work, the amount of the contract, the type of work to be performed, and an estimated schedule of DBE performance.

**C. Monthly Subcontractor Expenditure Records** - CONTRACTOR shall provide SCDOT a monthly report showing amounts paid to subcontractors on the Project. The report shall provide a running total of amounts paid to subcontractors on the Project, including the name of each subcontractor paid, the amount paid to each in that month, and the cumulative

amount paid to each as of the date of the report. The report shall also indicate whether the subcontractor is a DBE or non-DBE firm.

**D. SCDOT'S Right to Audit** - SCDOT will have the right to audit all documentation regarding DBE participation in the Project.

**E. Nondiscrimination** - CONTRACTOR, or subcontractor, shall not discriminate on the basis of race, color, national origin, or sex in the performance of this contract. CONTRACTOR shall carry out applicable requirements of 49 CFR Part 26 in the award and administration of SCDOT assisted contracts. Failure by CONTRACTOR to carry out these requirements is a material breach of this contract, which may result in the termination of this contract or such other remedy, as SCDOT deems appropriate.

## **XIX. ON-THE-JOB TRAINING REQUIREMENTS**

There is an On-The-Job Training Requirement for this Project. The number of persons to be trained under the On-the-Job Training Program during this Project is six (6) for Bridge. The CONTRACTOR shall comply with the requirements of the Federal-Aid Project Supplemental Specifications attached hereto as **EXHIBIT 7**. The CONTRACTOR shall submit its plan for On-the-Job Training to SCDOT for written approval prior to commencing construction activities.

## **XX. RECORD RETENTION**

**A.** CONTRACTOR shall maintain the following documents for a period of three (3) years or a period equal to the warranty period, whichever is longer, after Final Completion of the Project:

1. All CONTRACTOR samples and test reports;
2. Daily Diaries (substantially in the form of SCDOT's form 647, as revised 7/95);
3. Any other documents required to be retained in accordance with the Quality Control Plan.

**B.** During the retention period, SCDOT will be granted access to those documents upon reasonable notice. At any time during the retention period, SCDOT will have the option of taking custody of the documents. CONTRACTOR shall obtain a written release from SCDOT prior to destroying the records after the retention period.

## **XXI. AS-BUILTS**

**A.** In addition to those documents set forth elsewhere in this Agreement, CONTRACTOR shall provide to SCDOT prior to Final Completion, complete sets of as-built drawings (See Article XXI.D for details). As-built plans consist of the final version of the design

plan CADD drawings that incorporate all changes, including any adjustments, relocations, additions and deletions that occurred during construction. CONTRACTOR shall certify that the as-built plans are a true and correct representation of the work as constructed.

**B.** Information regarding major revisions to the plans shall be noted in a revision box on the plans. The information listed in the revision box shall include: the initiator of the revision, a brief explanation of the nature of the revision, and acceptance and approval from CONTRACTOR, along with associated dates.

**C.** In addition to the revisions that incorporated changes during construction, the as-built plans shall include the following information gathered during construction:

1. The location and elevation of foundations remaining below grade.
2. The final profile of each bridge constructed. The profile shall include the elevation along the centerline (or as specified by SCDOT) and a line three feet inboard of each gutter line. Points on the profile shall be taken at no greater than 25-foot intervals and shall include the beginning and end of each span.
3. If any structure has pile foundations, information concerning the pile driving operation shall be listed to include pile and driving equipment data, final pile bearing, elevation of pile tip when plan bearing was obtained, final pile tip elevation, penetration into the ground, and PDA or WEAP analysis data. This information shall be entered on each footing or bent sheet, or be included as a new sheet inserted immediately following the pertinent footing or bent sheet.
4. If any structure has drilled shaft foundations, information concerning the installation of the shaft shall be listed to include the drilled shaft report. This information shall be entered on each footing or bent sheet, or be included as a new sheet inserted immediately following the pertinent footing or bent sheet.
5. The final horizontal location of all existing and relocated utility lines and structures that are within the right-of-way. Include approved Utility Agreements, No Cost/No Conflict Letters, and Encroachment Permits.
6. The final location of all pipes, culverts, and drainage structures.
7. To include all right-of-way revisions, permissions, and an updated right-of-way data sheet to show the date and manner of acquisition of each tract

**D.** As-built plans shall be submitted as two (2) full size (36 inch x 22 inch) copies and one (1) copy on compact disc in a format acceptable to SCDOT. The levels and symbology of the as-built CADD drawings shall conform to SCDOT standard levels and symbology used to develop the design drawings for the Project.

## **XXII. ESCROW PROPOSAL DOCUMENTS**

### **A. Scope and Purpose**

The purpose of this article is to preserve the proposal documents of the successful proposer (CONTRACTOR) for use by the parties in any claims or litigation between SCDOT and CONTRACTOR arising out of this contract.

CONTRACTOR shall submit a legible copy of proposal documentation used to prepare the Technical and Cost Proposal for this contract to SCDOT. Such documentation shall be placed in escrow with a banking institution or other bonded document storage facility and preserved by that institution/facility as specified in the following sections of this specification.

### **B. Proposal Documentation**

The term "proposal documentation" as used in this specification means all writings, working papers, computer print outs, charts, and all other data compilations which contain or reflect information, data, and calculations used by CONTRACTOR to prepare the technical and cost proposal in proposing for the Project. The term "proposal documentation" includes, but is not limited to, equipment rates, overhead rates, labor rates, efficiency or productivity factors, arithmetic extensions, and quotations from subcontractors and material suppliers to the extent that such rates and quotations were used by CONTRACTOR in preparing, formulating and determining the technical and cost proposal. The term "proposal documentation" also includes any manuals that are standard to the industry used by CONTRACTOR in determining the proposal for the Project. Such manuals may be included in the proposal documentation by reference. Such reference shall include the name and date of the Publication and the Publisher. The term does not include proposal documents provided by SCDOT for use by CONTRACTOR in proposing on the Project.

### **C. Submittal of Proposal Documentation**

CONTRACTOR shall submit the proposal documentation to SCDOT, in a container suitable for sealing, no later than ten calendar days following award of the Contract by SCDOT. CONTRACTOR will not be allowed to begin work until the acceptable documentation has been received. The container shall be clearly marked "Proposal Documentation" and shall also show on the face of the container CONTRACTOR's name, the date of submittal, the File Number, and the Project Name.

### **D. Alternative Delivery Method**

CONTRACTOR may elect to use a delivery service to escrow the proposal documents directly with the escrow agent/facility as required under this Article. A delivery service with a tracking system such as FedEx, UPS, or DHL shall be used by the CONTRACTOR under this method of delivery. To affect delivery, CONTRACTOR is required to comply with the delivery procedures set forth under special provision entitled *Procedures to Escrow Bid Documentation by Delivery Service*, dated November 1, 2013, attached hereto as **EXHIBIT 10**. For purposes of this Agreement, the term bid documentation used in the special provision has the same meaning as proposal documentation in Section B above.

**E. Affidavit**

In addition to the proposal documentation, an affidavit, signed under oath by an individual authorized by CONTRACTOR to execute contracts shall be included. The affidavit shall list each proposal document with sufficient specificity so a comparison may be made between the list and the proposal documentation to ensure that all of the proposal documentation listed in the affidavit has been enclosed. The affidavit shall attest the following:

1. The affiant has personally examined the proposal documentation,
2. The affidavit lists all of the documents used by CONTRACTOR to determine the proposal for the Project, and
3. All such proposal documentation has been included.

**F. Verification**

Upon receipt of the proposal documentation, authorized representatives of SCDOT and CONTRACTOR will verify the accuracy and completeness of the proposal documentation compared to the affidavit. Should a discrepancy exist, CONTRACTOR shall immediately furnish SCDOT with any other needed proposal documentation. SCDOT, upon determining that the proposal documentation is complete, will, in the presence of CONTRACTOR's representative, immediately place the complete documentation and affidavit in the container and seal it. Both parties will deliver the sealed container to a banking institution or other bonded document storage facility selected by SCDOT for placement in a safety deposit box, vault or other secure accommodation.

**G. Duration and Use**

The proposal documentation and affidavit shall remain in escrow during the life of the Contract or until such time as CONTRACTOR files a claim or initiates litigation against SCDOT related to the contract. Receipt of CONTRACTOR's claim, or litigation against SCDOT, shall be sufficient evidence for SCDOT to obtain the release and custody of the proposal documentation. If no such claim is received or litigation initiated, the Final Estimate has been paid and the warranty period for the Contract has expired, SCDOT shall instruct the banking institution or other bonded document storage facility to release the sealed container to CONTRACTOR using the form provided in **EXHIBIT 10**.

CONTRACTOR agrees that the sealed container placed in escrow contains all of the proposal documentation used to determine the proposal and that no other proposal documentation shall be utilized by CONTRACTOR in litigation over claims brought by CONTRACTOR arising out of this contract.

**H. Refusal or Failure to Provide Proposal Documentation**

Refusal of CONTRACTOR to provide adequate documentation will be considered material breach of the Contract and CONTRACTOR will be declared in default of the

Contract. SCDOT may, at its option, terminate the contract for default. These remedies are not exclusive and SCDOT may take such other action as is available to it under the law.

**I. Confidentiality of Bid Documentation**

The proposal documentation and affidavit in escrow are, and will remain, the property of CONTRACTOR. SCDOT has no interest in, or right to, the proposal documentation and affidavit other than to verify the contents and legibility of the proposal documentation unless a claim is received or litigation ensues between SCDOT and CONTRACTOR. In the event of such claim or litigation, the proposal documentation and affidavit shall become the property of SCDOT.

**J. Cost and Escrow Instructions**

The cost of escrow will be borne by SCDOT. SCDOT will provide escrow instructions to the banking institution or other bonded document storage facility consistent with this article.

**K. Escrow Agreement**

CONTRACTOR agrees that it will sign an Escrow Agreement with SCDOT and the escrow agent consistent with this article. Should CONTRACTOR fail to sign the Escrow Agreement, when presented, CONTRACTOR may be declared in default of the Contract. The Escrow Agreement is attached in **EXHIBIT 10**.

**L. Payment**

There will be no separate payment for compilation of the data, container or cost of verification of the proposal documentation. All cost shall be included in the overall Contract Price.

**XXIII. DISPUTE RESOLUTION**

**A.** Each party hereby waives a trial by jury regarding any dispute between them arising out of this Contract and any such trial will be a non-jury trial before the South Carolina Circuit Court in Richland County.

**B.** In the event of a dispute between the parties, it shall be a condition precedent to litigation that the parties submit the dispute to the Standing Dispute Review Board pursuant to the Claims Procedure set forth in the Project Supplemental Specifications.

**C.** CONTRACTOR consents that any papers, notices, or process necessary or proper for the initiation or continuation of any disputes, claims, or controversies relating to the Agreement; for any court action in connection therewith; or for the entry of judgment on any award made, may be served on CONTRACTOR by certified mail (return receipt requested) addressed to CONTRACTOR at the address provided in Article XXVI. Notice by certified mail is deemed duly given upon deposit in the United States mail.

**XXIV. SCDOT'S AGENT**

SCDOT will appoint an individual who will be authorized to act on behalf of SCDOT, with whom CONTRACTOR may consult at all reasonable times, and whose instructions and decisions will be binding upon SCDOT as to all matters pertaining to this Agreement and the performance of the parties hereunder.

**XXV. ASSIGNABILITY**

The Contract shall not be assignable by CONTRACTOR without the prior written consent of SCDOT. SCDOT may assign the Contract without the consent of CONTRACTOR.

**XXVI. GENERAL PROVISIONS**

**A.** This Agreement shall be governed by and interpreted in accordance with the substantive laws of the State of South Carolina.

**B.** Headings and titles of the various parts of this Agreement are for convenience of reference only and shall not be considered in interpreting the text of this Agreement. Modifications or amendments to this Agreement must be in writing and executed by duly authorized representatives of each party.

**C.** In the event that any portion or all of this Agreement is held to be void or unenforceable, the parties agree to negotiate in good faith to reach an equitable agreement which shall affect the intent of the parties as set forth in this Agreement.

**D.** All notices pertaining to this Agreement shall be in writing and, if to SCDOT, will be sufficient when sent registered or certified mail to SCDOT addressed as follows:

Deputy Secretary for Engineering  
South Carolina Department of Transportation  
Post Office Box 191  
Columbia, South Carolina 29202-0191

All notices to CONTRACTOR shall be sufficient when sent registered or certified mail to CONTRACTOR addressed as follows:

(Insert CONTRACTOR'S address here)

**E.** The Contract Documents set forth the full and complete understanding of the parties as of the Effective Date defined herein, and supersedes any and all agreements and representations made or dated prior thereto.

**F.** The parties make no representations, covenants, warranties or guarantees, express or implied, other than those expressly set forth herein. The parties' rights, liabilities,



Agreement for US 701 Bridge Replacements  
Georgetown & Horry Counties

responsibilities and remedies within respect to the work shall be exclusively those expressly set forth in this Agreement.

**G.** In no event shall any failure by either party hereto to fully enforce any provision to this Agreement be construed as a waiver by such party of its right to subsequently enforce, assert or rely upon such provision.

**H.** Nothing in this Agreement is intended to create any contract rights for any party other than SCDOT and CONTRACTOR, nor are any third-party beneficiary rights intended to be created hereby.

Agreement for US 701 Bridge Replacements  
Georgetown & Horry Counties

IN WITNESS WHEREOF, the parties hereto have executed this Agreement as of the Effective Date defined herein. The Effective Date is defined as the date signed by the Director of Construction on behalf of South Carolina Department of Transportation.

Witnesses:

\_\_\_\_\_  
\_\_\_\_\_

SOUTH CAROLINA DEPARTMENT  
OF TRANSPORTATION

By: \_\_\_\_\_  
Todd Steagall, P.E.  
Director of Construction

Date: \_\_\_\_\_

\_\_\_\_\_

Recommended:

\_\_\_\_\_  
Jeff Elliott, P.E.  
Contract Administration Engineer

Witnesses:

\_\_\_\_\_  
\_\_\_\_\_

CONTRACTOR

\_\_\_\_\_  
*Name of Contractor*

By: \_\_\_\_\_

Its: \_\_\_\_\_

## CERTIFICATION OF CONTRACTOR

I hereby certify that I am the duly authorized representative of CONTRACTOR and that neither I nor the above CONTRACTOR I here represent has:

- a) employed or retained for a commission, percentage, brokerage, contingent fee, or other consideration, any firm or person (other than a bona fide employee working solely for me or the above CONTRACTOR) to solicit or secure this contract;
- b) agreed, as an express or implied condition for obtaining this contract, to employ or retain the services of any firm or person in connection with carrying out the contract, or
- c) paid, or agreed to pay, to any firm, organization or person (other than a bona fide employee working solely for me or the above CONTRACTOR) any fee, contribution, donation, or consideration of any kind for, or in connection with, procuring or carrying out the contract except as here expressly stated (if any);
- d) either directly or indirectly, entered into any agreement, participated in any collusion, or otherwise taken any action, in restraint of free competitive bidding in connection with the submitted proposal.

By execution of this Agreement, CONTRACTOR certifies CONTRACTOR and all CONTRACTOR's consultants, sub-consultants, contractors, employees and agents will comply with South Carolina's Ethics, Government Accountability, and Campaign Reform Act of 1991, as amended. The following statutes require special attention: (a) Offering, giving, soliciting, or receiving anything of value to influence action of public employee - §8-13-790, 8-13-705, 8-13-720; (b) Recovery of kickbacks - §8-13-790, (c) Offering, soliciting or recovering money for advice or assistance of public official - §8-13-720, (d) Use or disclosure of confidential information - §8-13-725, (e) Persons hired to assist in the preparation of specifications or evaluation of bids - §8-13-1150, (f) Solicitation of state employees - §8-13-755, 8-13-760 and §8-13-725, (g) False Claims Act -§16-13-240. The state may rescind any contract and recover all amounts expended as a result of any action taken in violation of this provision.

I acknowledge that this certificate is to be furnished to the Department, the Federal Highway Administration, and the U. S. Department of Transportation, and is subject to applicable State and Federal laws, both criminal and civil.

I acknowledge that giving false, misleading, or incomplete information on this certification may subject me to prosecution under Section 16-9-10 of the South Carolina Code of Laws.

CONTRACTOR

\_\_\_\_\_  
*Name of Contractor*

By: \_\_\_\_\_

Date: \_\_\_\_\_

Its: \_\_\_\_\_

## CERTIFICATION OF DEPARTMENT

I hereby certify that I am the Director of Construction for the South Carolina Department of Transportation (SCDOT) of the State of South Carolina and that the above CONTRACTOR or its representative has not been required, directly or indirectly, as an express or implied condition in connection with obtaining or carrying out this agreement to:

- (a) employ or retain, or agree to employ or retain, any firm or person, or
- (b) pay, or agree to pay, to any firm, person, or organization, any fee, contributions, donations, or consideration of any kind, except as here expressly stated (if any).

I acknowledge that this certificate is to be furnished to the Federal Highway Administration, and U. S. Department of Transportation, and is subject to applicable State and Federal laws, both criminal and civil.

SOUTH CAROLINA DEPARTMENT OF  
TRANSPORTATION

BY: \_\_\_\_\_

TITLE: DIRECTOR OF CONSTRUCTION

Date: \_\_\_\_\_

DRUG-FREE WORKPLACE CERTIFICATION

In accordance with Section 44-107-30, South Carolina Code of Laws (1976), as amended, and as a condition precedent to the execution of this agreement, the undersigned, who is an authorized representative of the PROPOSER certifies on behalf of the PROPOSER that the PROPOSER will provide a drug-free workplace by:

- (1) publishing a statement notifying employees that the unlawful manufacture, distribution, dispensations, possession, or use of a controlled substance is prohibited in the PROPOSER's workplace and specifying the actions that will be taken against employees for violations of the prohibition;
- (2) establishing a drug-free awareness program to inform employees about:
  - (a) the dangers of drug abuse in a workplace;
  - (b) the person's policy of maintaining a drug-free workplace;
  - (c) any available drug counseling, rehabilitation, and employee assistance programs; and
  - (d) the penalties that may be imposed upon employees for drug violations;
- (3) making it a requirement that each employee to be engaged in the performance of the agreement be given a copy of the statement required by item (1);
- (4) notifying the employee in the statement required by item (1) that, as a condition of employment of this agreement, the employee will:
  - (a) abide by the terms of the statement; and
  - (b) notify the employer of any criminal drug statute conviction for a violation occurring in the workplace no later than five days after the conviction;
- (5) notifying the South Carolina Department of Transportation within ten days after receiving notice under item (4)(b) from an employee or otherwise receiving actual notice of the conviction;
- (6) imposing a sanction on, or requiring the satisfactory participation in a drug abuse assistance or rehabilitation program by, any employee convicted as required in Section 44-107-50; and
- (7) making a good faith effort to continue to maintain a drug-free workplace through implementation of items (1), (2), (3), (4), (5), and (6)

By execution of this Agreement PROPOSER certifies PROPOSER and all PROPOSER's consultants, sub-consultants, contractors, employees and agents will comply with all applicable provisions of the Drug-Free Workplace Act, Title 44, Chapter 107 of the South Carolina Code of Laws, as amended.

PROPOSER: \_\_\_\_\_  
(Signature)

# **EXHIBIT 1**

## **COST PROPOSAL BID FORM**

**PROPOSED COST PROPOSAL BID FORM**

**FOR**

**REPLACEMENT OF US 701 BRIDGES OVER YAUHANNAH LAKE, GREAT PEE  
DEE RIVER, & GREAT PEE DEE OVERFLOW**

**GEORGETOWN & HORRY COUNTIES**

*The Cost Proposal Bid Form*, as submitted by the selected  
PROPOSER, will be included with the completed agreement.

# **EXHIBIT 2**

## **SCHEDULE OF VALUES**



**SCHEDULE OF VALUES**  
**FOR**  
**REPLACEMENT OF US 701 BRIDGES OVER YAUHANNAH LAKE, GREAT PEE**  
**DEE RIVER, & GREAT PEE DEE OVERFLOW**  
**GEORGETOWN & HORRY COUNTIES**

A Schedule of Values, submitted by the selected PROPOSER and approved by SCDOT, will be included with the completed agreement.

# **EXHIBIT 3**

## **SCOPE OF WORK**

## SCOPE OF WORK

### General

The CONTRACTOR is to perform, at a minimum, all work necessary to complete the replacement of the US 701 Bridges over the Yauhannah Lake, Great Pee Dee River, and Great Pee Dee Overflow as described within this Scope of Work, the Contract Agreement, and the Request for Proposals (RFP). This work shall be performed in accordance with all contract requirements. In carrying out this work, the CONTRACTOR is responsible for all contract services including, but not limited to, project administration, design, plan preparation services, demolition and construction services for roadway, bridge, and existing/abandoned foundations, maintenance of traffic, any necessary right of way acquisitions and acquisition services, utility coordination and relocation services, contractor quality control, environmental permits, mitigation, preparation of as-built plans, public/community relations, and any other service that may be necessary for the replacement of the bridges. ~~The CONTRACTOR shall maintain two lanes of traffic for the duration of construction.~~

As part of the design services, the CONTRACTOR shall complete the design throughout the project limits per the typical sections and criteria provided, and according to the details contained herein. The CONTRACTOR is fully responsible for compliance with the specifications and standards cited in all Contract Documents. Design submittals shall be provided in accordance with the Contract Agreement. Any deviation from the proposed design (whether necessary or desired by the CONTRACTOR) shall meet or exceed the contract requirements. If the project design necessitates a modification to any previously approved document (including but not limited to, the environmental document), the CONTRACTOR is responsible for the necessary studies and reports. Final review and approval lies with SCDOT and FHWA.

Acquisition and all costs associated with acquiring the necessary right-of-way shall be the responsibility of the CONTRACTOR. If additional right-of-way is required outside of the NEPA footprint, it shall be the responsibility of the CONTRACTOR to provide a re-evaluation of the NEPA document and to revise any permits deemed necessary to reflect the proposed right-of-way.

### Maintenance of Existing Bridges During Construction

As indicated in the SCDOT Standard Specifications, the CONTRACTOR shall be responsible for the routine maintenance of the existing bridges during the construction contract time beginning when SCDOT issues the Full Notice to Proceed #2. All costs associated with these services shall be included in the Contract Price. ~~Once construction begins, the CONTRACTOR shall be responsible for any damage to existing structures, including but not limited to settlement during vibration producing activities and damage during equipment operation.~~

SCDOT will continue to conduct inspections of the existing bridges in accordance with SCDOT policies. Upon completion of the inspections and after determining the needed repairs, SCDOT will take necessary measures required to ensure that the deficiencies are remediated or rendered harmless. Such necessary measures will include self-performing, retaining a qualified firm, or

negotiating a construction change order with the CONTRACTOR. Such work may include, but is not limited to, cribbing of beams (replacing shims and/or saddles) and repairing of spalls and/or decks as well as related items such as traffic control, snooper truck, and others.

As of the date of issuance of this final RFP, the existing bridges can support legal loads. The CONTRACTOR shall not operate equipment and/or vehicles on the existing bridges that exceed legal load limits.

## **Roadway**

The following items shall be included in the work:

1. Clear Zone:

CONTRACTOR shall provide adequate clear zone throughout project as defined in Exhibit 4a. In areas where new right-of-way or wetland impacts would be a result of achieving the clear zone requirement, substandard areas may be corrected or protected.

2. Pavement:

The design for pavement shall be selected from the designs listed in Exhibit 4c. The selected design shall be used throughout the length of the project.

3. Traffic:

- a) Pavement Markings: Provide durable pavement markings and surface mounted raised pavement markers throughout the limits of the project. Striping materials will be determined by the type of roadway surface as described in Exhibit 4d. Apply line widths and patterns in accordance with the Standard Drawings.
- b) Signs: Provide and install all permanent signing within the project limits as described in Exhibit 4d including the required advanced signs for interchanges that may be located beyond the project limits. The CONTRACTOR shall provide signing plans and sign layouts for SCDOT approval prior to ordering any materials. Traffic signing shall be in accordance with requirements of the 2009 MUTCD.

4. Guardrail:

Replace all existing mainline guardrail, ramp guardrail, and end treatments within the project limits. New guardrail shall be added where necessary in order to meet current design standards. The CONTRACTOR shall place a concrete curb in front of all new guardrail posts. The location and dimension for the concrete curb are shown in SCDOT Standard Drawing 803-105-00. The dimensions of the concrete

curb shall be as detailed in Attachment B. Use a minimum of Class 3000 concrete for all curbs in front of guardrail in place of bituminous material. CONTRACTOR shall pave the entire shoulder width in front of all new guardrail utilizing the mainline pavement design shown in Exhibit 4c. Instead of keying the curb into the pavement, the concrete curb may be constructed directly on the asphalt surface course. The curb shall be connected using 12" long by ½" diameter steel dowels with 10.5" embedment into the pavement at 5 foot intervals. The curb shall have tooled crack control joints at 50 foot intervals and Preformed Rubber Joint Filler (per QPL 81) expansion joints at 100 foot intervals.

5. Maintenance of Existing Roadway:

From NTP #2 until substantial completion, the CONTRACTOR shall maintain the existing roadway in accordance with SCDOT Standard Specifications for Highway Construction.

6. Removal/Abandonment of Existing Roadway:

The CONTRACTOR shall at a minimum comply with the Reclaiming Existing Roadway Special Provision in EXHIBIT 5. If existing fill/embankments are used in the final design, the soils shall meet the requirements of EXHIBIT 4f.

## Drainage and Hydrology

- A. The minimum low steel (low chord) elevation of the bridge is generally the lowest elevation of the bottom of the girders or main supporting element of the superstructure (i.e. bottom of flat slab). However, if other components, such as a pipe as part of a closed drainage system, encroach below the bottom of the girders, then the lowest elevation of the encroaching component will be considered the minimum low steel (low chord) elevation. The low chord elevation will be the constraint for setting the minimum finished grade at the bridge ends and the minimum vertical clearance above the navigable channel. Vertical clearance over the navigable channel will be 40 feet from the lowest part of the superstructure to Mean High Water (M.H.W.) elevation 3.0 (NAVD88). Provide span lengths that meet or exceed the requirements detailed in Exhibit 4. Outside of the navigable channel, the minimum freeboard shall be 7' for the Great Pee Dee River Bridge and 4' for both the Yauhannah Lake and Great Pee Dee Overflow Bridges.
- B. Provide sufficient right of way that erosion control measures may be properly maintained during construction for all measures and after construction for permanent measures.
- C. A closed drainage system on the bridges is required for this project and all drainage improvements for the Project shall be carried out in accordance with Exhibit 4b & 4e. The closed drainage system shall prohibit direct stormwater discharges into open water. The CONTRACTOR shall implement appropriate best management practices and post construction stormwater treatment to provide a reasonable assurance that the proposed project will not contribute to impairments or degrade water quality.

- D. CONTRACTOR shall perform a hydraulic analysis and scour study, in accordance with the Department’s “Requirements for Hydraulic Design Studies” dated May 26, 2009, to determine the required bridge length, grade, and span arrangement. Provide span lengths over the channel that meet or exceed the requirements detailed in Exhibit 4.
- E. CONTRACTOR shall install temporary slope drains on both sides of the road at all proposed bridge ends to accommodate stormwater runoff during construction.

## Structures

The Project includes, at a minimum, the following items:

- A. Design and construction of the bridge replacements included on the Cost Proposal Bid Form included as Exhibit 1. Design and construction of the bridge replacements in accordance with the criteria, specifications, and contract provisions.
- B. Provide bridge dimensions that meet or exceed the dimensions shown in the Design Criteria – Exhibit 4.
- C. Remove and dispose of the existing bridges and appurtenances in accordance with the SCDOT Standard Specifications for Highway Construction, Edition of 2007, related Special Provisions, and all applicable laws and regulations. The CONTRACTOR will be required to demonstrate through adequate surveying and reporting that substructures of existing structures and other obstructions have been removed within the right-of-way as required in Section 202.4.2 of SCDOT’s 2007 Standard Specifications for Highway Construction. In addition, the scope includes the demolition and stabilization of structures from the abandoned portions of US 701, including foundations and obstructions, with exception to those portions that require private property access. In conjunction with the Environmental Assessment’s Cultural Resources Survey, SCDOT consultants performed a Phase I Underwater Archeological Survey which is included, for information only, in Attachment B. This survey included information about underwater obstructions in the vicinity of the project.
- D. Coordinate with the United States Geological Survey (USGS) regarding the removal and installation activities related to the storm-tide sensor brackets that are located on the existing bridge. USGS will be responsible for expenses of relocation of the brackets to the new bridge. The contact information for USGS is shown below:

John Shelton, Hydrologist  
USGS – Southeast Area  
720 Gracern Road  
Columbia, SC 29210  
Phone: (803) 750-6112  
Email: [jmshelto@usgs.gov](mailto:jmshelto@usgs.gov)

- E. Piers are disallowed within the area designated for navigation – Exhibit 4.

## EXHIBIT 3 – SCOPE OF WORK

- F. The CONTRACTOR shall be responsible for removal and/or management of any underground structures or obstructions that are encountered during installation and construction of new foundation elements. In conjunction with the Environmental Assessment's Cultural Resources Survey, SCDOT consultants performed a Phase I Underwater Archeological Survey which is included, for information only, in Attachment B. This survey included information about underwater obstructions in the vicinity of the project.
- G. The CONTRACTOR shall comply with SCDOT Special Provision Monitoring of Construction-Related Earthborne Vibrations. In addition, the CONTRACTOR shall monitor the existing bridges and roadway approaches for settlement during construction. The CONTRACTOR shall prepare a plan for existing bridge and roadway settlement monitoring. The monitoring plan shall include data points and collection of elevation data at all existing bents and a distance of 200 feet at each bridge approach in intervals of 50 feet. At the start of NTP #2, the CONTRACTOR shall record data at all points once per month. During vibration producing construction activities at any given local site, nearby points shall be continuously monitored by CONTRACTOR. The distance from any local site to nearby monitored points shall be defined in the CONTRACTOR's monitoring plan. The monitoring plan shall be submitted for SCDOT concurrence within 180 days after NTP #1.

The CONTRACTOR shall be responsible for remediation of settlement of the existing bridges that occurs anytime during all construction phases that include/require vibration producing activities. This settlement is not limited to those points that are actively being monitored in accordance with the CONTRACTOR's settlement monitoring plan. The CONTRACTOR shall prepare a settlement remediation plan that is detailed sufficiently to comply with this requirement. The remediation plan must clearly describe these parameters to ensure that risk allocation of settlement between the CONTRACTOR and SCDOT is well-defined during all construction phases of this project. The remediation plan shall include schedules, durations, and types of potential vibration producing activities as well as durations for possible consolidation settlements that may occur after the activities are completed. Implementation of the settlement remediation plan cannot proceed until the plan is concurred with in writing by SCDOT. SCDOT intends to use the remediation plan to limit and define responsibilities related to settlement. SCDOT shall not hold the CONTRACTOR responsible for settlement caused by normal traffic loadings. The remediation plan shall be submitted 45 days prior to NTP #2. At any time, if settlement occurs simultaneously with vibration producing activities, the CONTRACTOR shall immediately stop those activities. The CONTRACTOR shall then submit a detailed plan for repair, perform the repairs at no cost to SCDOT and develop and submit for review a revised construction plan to address the vibration problems and minimize further damage.

## **Geotechnical**

The following items, at a minimum, shall be included in the scope of work:

- A. As necessary, provide pile and drilled shaft dynamic and/or static load testing as outlined in the design criteria and in accordance with the project specifications and Special Provisions. The results shall be used to determine capacities of the associated foundation system.
- B. Design and construct any ground improvement needed to ensure that the approach embankments meet the resistance factors and performance limits outlined in the SCDOT Geotechnical Design Manual (GDM). Design and construction of the ground improvement shall be in accordance with the criteria, specifications, and contract provisions.
- C. CONTRACTOR shall instrument and monitor the approach embankments, as necessary, to ensure that the performance limits outlined in the GDM are met prior to construction of pavement sections.
- D. All geotechnical design and construction for the Project shall be carried out in accordance with Exhibit 4f.
- E. The Roadway Structure Operational Classification (ROC) is provided in **EXHIBIT 4f**.

## **Utility Coordination**

The CONTRACTOR shall conduct sufficient site surveys to locate and identify all utilities that may be affected by the bridge replacement. The CONTRACTOR shall provide utility coordination, relocation services, and identify prior rights for the construction of the Project. The CONTRACTOR shall include in his bid, the cost of coordination services for all utilities that may be affected. The cost of relocation of utilities with prior rights will be the responsibility of SCDOT. For any utility having prior rights, the CONTRACTOR will be responsible for developing the utility agreement for SCDOT approval. For those utilities where SCDOT has prior rights, the CONTRACTOR may exercise SCDOT's prior rights and require the utility company to bear the costs of relocation. CONTRACTOR shall comply with the utility coordination and relocation requirements set forth in Attachment A – Project Agreement.

## **Right of Way**

The CONTRACTOR shall be responsible for any right-of-way acquisition required for the project, to include any relocations or permissions needed to accommodate slopes, drainage, permitting or any other Project requirements. The acquisition and all costs associated with the acquisition of additional right-of-way shall be included in the Total Project Cost by the CONTRACTOR. CONTRACTOR shall comply with right of way services and acquisition requirements set forth in Attachment A – Project Agreement. If additional right of way is necessary beyond what has been evaluated in the NEPA documentation, CONTRACTOR shall be responsible for any re-evaluation of the approved Environmental Documents. **Information about present right-of-way widths adjacent to the Refuge is located in the Environmental Assessment Appendix A and Appendix B, page B-105.**



In order to satisfy Section 4(f) as described in the Environmental Assessment, Page 59 and Appendix A, the CONTRACTOR shall prepare a technical memorandum/recommendation that provides appropriate certification for the value of Refuge replacement property which includes but is not limited to real estate appraisals and natural resources assessments of at least three (3) similar and available properties. The CONTRACTOR shall be responsible for coordinating with the Refuge to ensure that Section 4(f) requirements are satisfied. Based on this certification, SCDOT shall provide compensation to the Refuge.

In regards to property acquisition from the Refuge, necessary to construct the project, the CONTRACTOR shall (1) be responsible for all services and payment to the Refuge for the “just compensation” value of the property taken in accordance with Article VIII of the Agreement, and (2) assist SCDOT in complying with the Section 4(f) Agreement by providing all right of way services (excluding acquisition) necessary to identify substitution property of reasonably equivalent usefulness and location for the property taken. The CONTRACTOR shall provide SCDOT with appraisals of at least three available properties. The CONTRACTOR’s services in (1) and (2) above shall be closely coordinated with SCDOT and shall be included in the Total Contract Price.

Upon acceptance of the CONTRACTOR’s appraisals for substitution property, SCDOT will coordinate with the Refuge and be responsible for any further payments necessary to satisfy the 4(f) Agreement pertaining to property acquisition. While SCDOT will bare this risk, the CONTRACTOR shall not be entitled to any additional cost or time for any delays, inconveniences, or damages sustained as a result of SCDOT satisfying the requirements set forth in the Section 4(f) Agreement.

## **Work Zone Traffic Control**

The Project shall contain at a minimum the following items:

1. Provide all necessary Traffic Control as required by the Standard Specifications, Supplemental Specifications, Standard Drawings for Road Construction, and Special Provisions.
2. Prepare and submit a Transportation Management Plan (TMP) and special provisions for SCDOT’s acceptance prior to any construction activity. The TMP includes Temporary Traffic Control, Traffic Operations, and Public Involvement plans as detailed Part 6 of the Manual on Uniform Traffic Control Devices (MUTCD) latest edition and SCDOT policies including the Rule on Work Zone Safety and Mobility, the standard specifications and all addendums to the standard specifications, all supplemental specifications, the typical traffic control standard drawings for road construction and any special provisions included in this contract. All costs associated with the design, development, implementation, and maintenance of the TMP shall be the responsibility of the PROPOSER and will be included in the Total Project Cost. SCDOT shall review and accept the TMP prior to commencing any construction activities.

3. Temporary Traffic Control Plans shall be submitted to SCDOT for review a minimum of 15 SCDOT work days prior to beginning any work in the area. Plans shall include a description of the sequenced steps to be followed in implementing the plans, and will be developed at a scale of 1" = 50', unless otherwise agreed upon. Potential items for inclusion in a Temporary Traffic Control plan (TTC) will include but are not limited to lane closures, shoulder closures, road closures, traffic relocations, detours, traffic control devices, temporary pavement construction, temporary pavement markings, construction signing and sequencing notes. Maintain the number of travel lanes and all traffic movements, for the duration of the project unless otherwise approved by the Department. Design all aspects of the traffic control plan to consider lane widths, shoulder widths, clear zones, curves and reverse curves, lane shifts, taper lengths, lane drops, stopping sight distance, buffer areas, placement of traffic control devices, etc. and to comply with the speed requirements of the roadway prior to initiation of the project or beginning the work or the implementation of a reduced speed limit due to a previous road defect. On roadways with original travel lane widths of 11 feet or greater prior to beginning work, the travel lane widths may be temporarily reduced by no more than 1 foot if deemed necessary and approved by the Department. Maintain minimum temporary travel lane widths of no less than 11 feet on interstate and intermediate to high speed primary routes.

Minimize shoulder width reductions. On roadways with paved shoulders, maintain a minimum total width of paved shoulder area no less than 5 feet wide with a minimum 3-foot / 2-foot split between each paved shoulder; provide a minimum width of 2 feet of paved shoulder on one side of the travel way with a minimum width of 3 feet of paved shoulder on the other side of the travel way. On bridge structures, maintain a minimum total width of shoulder area no less than 4 feet wide with a 2-foot / 2-foot split between each shoulder; provide no less than 2 feet of shoulder width on each side of the travel way.

A separation of adjacent travel lanes in the same direction of travel shall require approval by the Department. If a separation of adjacent travel lanes in the same direction of travel is approved by the Department, the approved separation of travel lanes shall not exceed one separation event per direction.

4. The CONTRACTOR shall execute all Traffic Control in accordance with Exhibit 4d – Part 2.

## **Environmental**

The CONTRACTOR shall give extra attention throughout his operations to minimizing impacts to the environment. As a minimum the CONTRACTOR shall include the following in the Project:

- A. SCDOT has prepared the necessary environmental documents consistent with the NEPA process including any necessary studies. The project has been advanced through the environmental phase with the approval of an Environmental Assessment and a subsequent Finding of No Significant Impact (FONSI), a copy of which is included in Attachment B.
- B. In preparing the environmental documentation, SCDOT has made certain assumptions regarding project construction. If the PROPOSER elects to construct the project in a

### EXHIBIT 3 – SCOPE OF WORK

manner that is not consistent with the assumptions in the SCDOT prepared environmental documents, the PROPOSER will be responsible for preparing any necessary environmental re-evaluation and providing any additional studies that may be required. All revisions to or re-evaluations of the environmental documents will require SCDOT and FHWA approval prior to any construction activity. It is the PROPOSER'S responsibility to comply with all commitments listed in the environmental documents.

- B. The CONTRACTOR will be responsible for obtaining any permits required by federal, state, or local laws or regulations. All work, including additional cost and time associated with any permit or permit modification as a result of changes proposed by the CONTRACTOR shall be the CONTRACTOR's responsibility. The CONTRACTOR will not be entitled to any additional cost or time associated with obtaining any permit required. CONTRACTOR will be responsible for obtaining any permits required by federal, state, or local laws or regulations.
- C. For those permits that must be submitted in the name of SCDOT, the permit applications shall be forwarded to SCDOT for review and submission. Coordination with agencies must be routed through the SCDOT Environmental Management Office. The CONTRACTOR shall stake out and delineate the jurisdictional areas in accordance with the preliminary jurisdictional determination issued by the USACE, and OCRM's approved Critical Line plat, and the project Special Provisions. It is anticipated that a United States Coast Guard Bridge Permit, Section 404 Permit, Coastal Zone Consistency Determination, and a Section 401 Water Quality Certification are required and shall be the responsibility of the CONTRACTOR to obtain.
- D. ~~All costs of obtaining the permits, including any updates to the jurisdictional determination and mitigation required by permits, shall be the responsibility of the CONTRACTOR and included in the Total Project Cost.~~ The CONTRACTOR shall prepare and submit to SCDOT a mitigation plan in conjunction with the Section 404 permit package. The mitigation plan shall be prepared in accordance with the USACE Charleston District's ~~Standard Operating Procedures (SOP) guidelines~~ for mitigation. SCDOT will provide up to 219 wetland mitigation credits at no cost to the CONTRACTOR. The CONTRACTOR shall be responsible for any mitigation costs related to impacts exceeding 219 wetland mitigation credits. At the time of issuance of this RFP, the USACE guidance indicates that any temporary impacts that remain in place longer than one year require mitigation.
- E. All work associated with any permit modifications as a result of changes proposed by the CONTRACTOR shall be the CONTRACTOR's responsibility. The CONTRACTOR will not be entitled to any additional cost or time associated with obtaining any permit required as a result of CONTRACTOR design change, except as provided in Article IX - Permits in Attachment A – Project Agreement.
- F. The CONTRACTOR shall provide an Environmental Plan for the Project. The plan shall be submitted to SCDOT for approval prior to any construction activity. The plan shall identify specific measures that the CONTRACTOR will implement to assure compliance with all environmental documents, permits, and other environmental commitments as may be detailed in the contract documents. The plan shall also designate specific personnel that

## EXHIBIT 3 – SCOPE OF WORK

are charged with carrying out monitoring and compliance activities included in the plan. The plan shall include necessary coordination with the Refuge Manager involving, but not limited to, Environmental Commitment Numbers 3, 6, 7, 8, 12, 13, & 14 as shown in Exhibit 8.

- G. The CONTRACTOR shall fulfill all Environmental Commitments in Exhibit 8.
- H. All jurisdictional areas not to be impacted should be delineated/identified for protection by temporary barrier fencing as per instructions identified in Instructional Bulletin dated March 14, 2013. The approved approximate Jurisdictional Determination expires in January 2015. SCDOT will obtain an updated Jurisdictional Determination prior to NTP #1. SCDOT will provide the Jurisdictional Determination request package via addendum.
- I. Regarding Environmental Commitment Number 14, Item c, the CONTRACTOR shall refer to EXHIBIT 3, Right of Way and EXHIBIT 8. ~~prepare a technical memorandum/recommendation for mitigation of Section 4(f)/6(f) impacts to the Refuge. The CONTRACTOR's recommendation shall include locating, appraising, and assessing natural resources on at least three (3) similar and available properties. SCDOT will be responsible for the cost of mitigation of Section 4(f)/6(f) impacts to the Refuge. The CONTRACTOR shall be responsible for coordinating with the Refuge to ensure that Section 4(f) requirements are satisfied.~~
- J. Regarding construction access, at the time of issuance of this RFP, the USACE Charleston District's guidance indicates that temporary haul roads and/or causeways are not preferred, but work trestles, barges, and timber mats are acceptable. The CONTRACTOR shall avoid the vegetated buffer area adjacent to and surrounding Cowford Lake which is on the downstream side of the project in Horry County. Details of this area are noted in the EA and EA Appendix A.

### **Partnering**

SCDOT values a partnering approach on projects and as such this project will require regular Partnering Sessions. The objectives are effective and efficient contract performance and completion within budget, on schedule, and in accordance with the contract requirements. The CONTRACTOR is to include the cost of partnering activities in the Total Project Cost. The cost of the partnering activities will be shared equally between the CONTRACTOR and SCDOT. The CONTRACTOR should anticipate two (2) Partnering Sessions for this Project.

### **Community Relations**

The CONTRACTOR shall provide to SCDOT for review and written approval a Community Relations Plan as part of the Project. The Community Relations Plan shall describe how the CONTRACTOR will actively promote good relationships with local elected officials, the Waccamaw National Wildlife Refuge (WNWR), the news media, and the community at large. All costs associated with community relations will be included in the Total Project Cost.

EXHIBIT 3 – SCOPE OF WORK
---------------------------

SCDOT will expect the CONTRACTOR to maintain positive communications with the local community (including public meetings as necessary), the adjacent property owners, and local businesses. The Community Relations Plan shall be submitted within 45 calendar days of NTP #1.

The CONTRACTOR shall outline a plan for communicating with the WNWR on matters such as, but not limited to, construction schedule, boat ramp closures, lane and/or road closures, and above mentioned Environmental Commitment compliance.

The Project includes compliance with Engineering Directive Memorandum Number 36, Public Notification of Bridge Replacement Projects. All public notification correspondence shall be prepared for the signature of the appropriate SCDOT Official as required by Engineering Directive Memorandum Number 36. The Contractor shall also regularly advise local media in advance of road closures and when the road is reopened to traffic.

# **EXHIBIT 4**

## **PROJECT DESIGN CRITERIA**

EXHIBIT 4 – PROJECT DESIGN CRITERIA
-------------------------------------

This exhibit details the criteria by which the project must be designed and constructed. These criteria are divided into subsections as listed below:

Exhibit 4a. Road

Exhibit 4b. Structures

Exhibit 4c. Pavement

Exhibit 4d. Traffic

Part 1 – Signing and Pavement Markings

Part 2 – Work Zone Traffic Control

Exhibit 4e. Hydraulic

Exhibit 4f. Geotechnical

**DESIGN REFERENCES**

This exhibit describes the general design considerations and criteria for the proposed roadway approaches, hydraulics, structures, traffic signal design, and surveys.

Design standards shall be in accordance with the following design references as supplemented or amended by Sections 4a, 4b, 4c, 4d, 4e, and 4f of this Exhibit:

- SCDOT Pre-Construction Survey Manual, effective as of Final RFP release date
- 2003 SCDOT Highway Design Manual with updates effective as of the Final RFP release date and supplemented with AASHTO A Policy on Geometric Design of Highways and Streets, 2001
- AASHTO Roadside Design Guide, with 2006 Chapter 6 update, 3<sup>rd</sup> Edition
- SCDOT Requirements for Hydraulic Design Studies, May 2009
- SCDOT Standard Drawings, effective as of the Final RFP release date
- SCDOT Engineering Directive Memorandums, effective as of the Final RFP release date
- SCDOT Instructional Bulletins, effective as of the Final RFP release date
- AASHTO Guide for the Development of Bicycle Facilities, 1999
- AASHTO Guide for the Planning, Design, and Operation of Pedestrian Facilities, 2004
- SCDOT Americans with Disabilities Act Transition Plan, January 2009
- SCDOT Roadside Plants to Avoid/Trees with Limitations on R/W, June 2008
- SCDOT Access and Roadside Management Standards, August 2008 with updates
- SCDOT Plan Preparation Guide, 2000
- SCDOT Standard Specifications for Highway Construction, 2007
- SCDOT Supplemental Specifications, effective as of the Final RFP release date
- SCDOT Supplemental Technical Specifications, effective as of the Final RFP release date
- SCDOT Qualified Product Lists, effective as of the Final RFP release date
- FHWA Manual on Uniform Traffic Control Devices (Latest Edition)
- SCDOT Supplement to the MUTCD
- The Rule on Work Zone Safety and Mobility
- Highway Capacity Manual, 2000
- SCDOT Traffic Engineering Guidelines
- SCDOT Preconstruction Advisory Memorandums, effective as of the Final RFP release date
- AASHTO “Highway Drainage Guidelines”
- SCDOT Bridge Design Manual, 2006
- SCDOT Bridge Design Memoranda, effective between July 1, 2006 and the Final RFP release date
- 2012 AASHTO LRFD Bridge Design Specifications, Sixth Edition (with Interim Revisions)
- AASHTO Vessel Collision Design of Highway Bridges, Second Edition, 2009, with 2010 Interim Revisions



- SCDOT Geotechnical Design Manual, 2010 Edition (Version 1.1)
- SCDOT Seismic Design Specifications for Highway Bridges, 2008 (Version 2.0)
- SCDOT Bridge Design Drawings and Details, effective as of the Final RFP release date
- AASHTO/AWS D1.5M/D1.5:2010 Bridge Welding Code, with 2011 interims
- AASHTO “Standard Specifications for Structural Supports for Highway Signs, Luminaires and Traffic Signals”, effective as of the Final RFP release date
- Road Design Reference Material for Consultant Prepared Plans, June 2010
- Highways in the Coastal Environment, HEC 25, June 2008, 2<sup>nd</sup> Edition
- Tidal Hydraulic Modeling for Bridges, Ayres Associates, March 2002

Any variation in design from the included information shall require written approval from SCDOT.

### **Abbreviations**

The following abbreviations will be used herein to designate standard specifications for material and workmanship:

- AAMA -American Architectural Manufacturers Association
- AASHTO - American Association of State Highway and Transportation Officials
- ADA – Americans with Disabilities Act
- AISI - American Iron and Steel Institute
- AISC - American Institute of Steel Construction
- ALSC - American Lumber Standard Committee
- ANSI - American National Standard Institute
- ASTM - American Society of Testing Materials
- AWS - American Welding Society
- CRSI - Concrete Steel Reinforcing Institute
- FHWA - Federal Highway Administration
- GDM – SCDOT Geotechnical Design Manual
- IEEE-Institute of Electrical and Electronic Engineers
- LRFD - Load and Resistance Factor Design
- LRFR – Load Rating and Resistance Factor Rating
- MUTCD – Manual on Uniform Traffic Control Devices
- NEMA - National Electrical Manufacturers Association
- NETA- International Electrical Testing Association
- OSHA - Occupational Safety and Health Act
- PCI – Prestressed Concrete Institute
- RCE – SCDOT Resident Construction Engineer
- SCDOT - South Carolina Department of Transportation
- SSPC - Steel Structure Painting Council

**DESIGN DELIVERABLES**

The CONTRACTOR is solely responsible for the accuracy, completeness, and constructability of the submitted deliverables before and after review. The CONTRACTOR is reminded that the SCDOT reviews the working drawings and design calculations only to insure that the specifications have been addressed.

All submittals to SCDOT shall be subjected to a thorough QA/QC review by the CONTRACTOR prior to submittal and all final submittals shall be signed and sealed by the Engineer of Record who shall be licensed and registered as a Professional Engineer in the State of South Carolina

**ROADWAY DESIGN DELIVERABLES**

**Preliminary Plans**

Eight half-sized (8) sets of preliminary plans shall include, at a minimum: roadway typical section, roadway plan and profile, cross sections, drainage features, proposed right-of-way, construction staging details, boat ramp, boat ramp access, and boat ramp parking area plan and profile, Refuge access plan and profile, and preliminary geotechnical reports.

CONTRACTOR shall provide any design calculations requested in writing by SCDOT. CONTRACTOR shall provide one electronic copy of the plans and calculations.

**Right of Way Plans**

Eight half-sized (8) sets of Right of Way plans are not a required submittal. However, if right of way is required and the CONTRACTOR wishes to pursue right of way acquisition prior to Final Plan submittal, CONTRACTOR has the option to submit Right of Way Plans. If the CONTRACTOR elects to submit Right of Way plans, one electronic copy is required.

Right of Way plans shall include, at a minimum: Right of Way data, roadway typical section, roadway plan and profile, cross sections, drainage features, boat ramp, boat ramp access, and boat ramp parking area plan and profile, Refuge access plan and profile, existing Right of Way, and proposed new Right of Way requirements.

**Final Plans**

Eight half-sized (8) sets of Final plans shall include, at a minimum: roadway typical section, roadway plan and profile, cross sections, drainage features, sediment and erosion control features, existing right-of-way, proposed right-of-way, construction staging details, proposed barrier locations, boat ramp, boat ramp access, and boat ramp parking area plan and profile, Refuge access plan and profile, and final geotechnical reports. CONTRACTOR shall also provide any design calculations requested in writing by SCDOT. CONTRACTOR shall provide one electronic copy of the plans and calculations.

As – Built Construction Plans shall adhere to Road Design Reference Material for Consultant Prepared Plans, latest edition for Construction Plans.

## HYDRAULIC DESIGN DELIVERABLES

### **Preliminary Hydraulic Design Submittal**

The CONTRACTOR shall provide one (1) Hard copy and an electronic copy of the Hydraulic Design Calculations to SCDOT with the Preliminary Plans. Hydraulic Design Calculation submittal shall include calculations for drainage structures and calculations for sediment and erosion control and all calculations and models associated with the proposed bridge configurations.

### **Final Hydraulic Design Submittal**

The CONTRACTOR shall provide the following to the Department with the Final Plan submittal:

- Four (4) signed, completed copy of the SCDHEC Notice of Intent (NOI), and CZC package (if applicable)
- ~~One (1)~~ Four (4) hard copies of the Bridge Hydrology and Hydraulic Report,
- ~~One (1)~~ Four (4) hard copies of the Final Drainage Report and Stormwater Management Report,
- Four (4) complete “No-Impact” Certification (if applicable)
- One electronic copy of each submittal.

## STRUCTURAL DESIGN DELIVERABLES

### **Preliminary Structural Design Plans**

Where applicable, SCDOT Bridge Drawings and Details shall be utilized (available on SCDOT website).

The Contractor shall submit eight (8) half size sets and one electronic set of preliminary plans. Three copies of the preliminary geotechnical report and an electronic copy shall be included with the preliminary plans submittal.

### **Preliminary Seismic Design Summary Report**

Along with the preliminary bridge plans submittal, the Contractor shall submit preliminary seismic summary report (three copies and one electronic copy) documenting the strategy that will be used to achieve the required seismic performance criteria for the bridge. The report shall describe the seismic design approach for the bridge and shall include, at a minimum, the following information:

- A discussion of the expected performance of the bridge in regard to elastic and inelastic behavior (locations where plastic hinging is expected)
- Target ductility demand
- A description of design features required to meet the critical performance requirements of the *SCDOT Seismic Design Specifications for Highway Bridges*
- The name(s) of computer software that will be used for modeling
- Any unique structural and geotechnical issues affecting the seismic design
- The design response spectrum (when a site-specific study is required)

If any changes to the seismic design strategy are made during the design process, the Consultant shall modify the report and resubmit it to the Department for review.

### **Final Structural Design Plans**

Final Structural Design Plans shall include eight (8) half size sets, one and one electronic copy and, at a minimum, all documents, reports, and calculations described in Chapter 3 of the SCDOT Bridge Design Manual. Three (3) copies of the final geotechnical report and one electronic copy shall be included with the final plans submittal.

Final plan submittals to SCDOT shall be signed and sealed by the State of South Carolina licensed Professional Engineer of record. CONTRACTOR shall provide any design calculations requested in writing by SCDOT. No construction shall begin until all comments are resolved and SCDOT acceptance is given.

### **Final Seismic Design Summary Report**

Along with the final bridge plans submittal, the Contractor shall submit final seismic summary report (three (3) hard copies and one electronic copy).

### **Release for Construction (RFC) Plans**

For roadway and structural plans, CONTRACTOR shall provide one (1) full size set, eight (8) half size sets, and one electronic copy of RFC Plans to SCDOT. RFC Plans shall be inserted into plan folders as detailed in the SCDOT bridge design manual and the SCDOT plan and preparation guide.

### **Foundation Installation Plans**

The CONTRACTOR shall prepare Drilled Foundation Installation Plans (DFIP) and/or Pile Installation Plans (PIP) in accordance with the Standard Specifications for Highway Construction. The CONTRACTOR's designer shall review and approve all DFIP and PIP (including pile driving criteria) prior to submitting the foundation installation plans to SCDOT for review and acceptance. SCDOT will review the foundation installation plans and provide either acceptance or comments. Comments must be resolved by the CONTRACTOR's designer prior to re-submittal to SCDOT. The CONTRACTOR is

reminded that the SCDOT reviews the DFIP and/or the PIP only to insure that the specifications have been addressed.

**Shop Plans**

Shop plans, as defined by the Standard Specifications for Highway Construction, shall be submitted to the CONTRACTOR’s designer for review and approval. All approved shop plans shall be routed to SCDOT for review and distribution. Shop plan submittals shall meet the criteria of Subsection 725.1.1 of the Standard Specifications for Highway Construction. After reviewing the plans, SCDOT will either distribute the plans or provide comments. Comments shall be reviewed and approved by the CONTRACTOR’s designer prior to the plans being resubmitted to the SCDOT for further review. Shop plans shall be stamped “approved” by the CONTRACTOR’s designer prior to submittal to SCDOT and shall be stamped and distributed by the SCDOT prior to commencing fabrication and/or construction/erection. All design calculations and shop plans shall bear the legible seal, date, and signature of the responsible engineer registered as a Professional Engineer in the State of South Carolina.

As supplement to Standard Specification Subsection 725.1.1, processing of Shop Plans shall be in accordance with Bridge Design Memorandum – DM0207 which could be found on SCDOT web site <http://www.scdot.org/doing/structural.aspx>.

**Working Drawings**

Working drawings and design calculations, as defined by the Standard Specifications for Highway Construction, shall be submitted to the CONTRACTOR’s designer for review and approval. All approved working drawings and design calculations shall be routed to the SCDOT for review and distribution. Working drawings and design calculation submittals shall meet the criteria of Subsection 725.1.2 of the Standard Specifications for Highway Construction. SCDOT will review the drawings and calculations and either provide acceptance of the drawings as prepared or provide written comments to the drawings. Comments shall be reviewed by the CONTRACTOR’s designer prior to re-submittal to the SCDOT for further review. Working drawings and design calculations shall be stamped “approved” by the CONTRACTOR’s designer prior to submittal to SCDOT and shall be stamped and distributed by the SCDOT prior to commencing construction/erection. All design calculations and working drawings shall bear the legible seal, date, and signature of the responsible engineer registered as a Professional Engineer in the State of South Carolina.

**GEOTECHNICAL DESIGN DELIVERABLES**

Three-Point Acceleration Design Response Spectrum (ADRS) curves have been supplied in Exhibit 4f, for the SEE and FEE design events. The CONTRACTOR shall incorporate these in the design of the embankments and bridge structures. However, based on the geotechnical information provided in the Geotechnical Base Line Report (S&ME, 2013) the CONTRACTOR may perform a Site-Specific Response Analysis (SSRA) and develop

EXHIBIT 4 – PROJECT DESIGN CRITERIA
-------------------------------------

a set of ADRS curves for design of the embankments and bridge structures. If the CONTRACTOR elects to perform an SSRA, the analysis shall be developed in accordance with the design criteria provided in Exhibit 4f. Also, if, an SSRA is performed, the CONTRACTOR shall prepare preliminary and final SSRA reports. The preliminary report shall describe the design approach that will be followed to develop the SSRA and shall include, as a minimum a discussion of existing and proposed geotechnical information, design methodology, name(s) of computer software that will be used for modeling, and ground motions selection. The final report shall summarize all findings of the SSRA and shall include, as a minimum the subsurface information used, geotechnical and structural issues affecting the site response analysis, site characterization, and the ADRS curves to be included in the Preliminary Seismic Design Summary Report. The review of the reports will be performed in accordance with the submittal plan review process.

The CONTRACTOR shall prepare separate preliminary and final geotechnical reports for the bridge, and separate preliminary and final geotechnical reports for the roadway which shall include the geotechnical design of roadway embankments, retaining walls, culverts, and/or any other roadway structure. The reports shall, as a minimum, contain all that is described in Chapter 21 of the *SCDOT Geotechnical Design Manual*. Also, the reports shall have design details and plan notes along with data that are consistent with that shown in the preliminary and final bridge and road plans. In addition, the CONTRACTOR's designer shall prepare the required geotechnical roadway plan sheets that clearly detail any geotechnical requirements outlined in the reports. The reports and plans shall bear the legible seal, date, and signature of the responsible engineer registered as a Professional Engineer in the State of South Carolina. Each report shall be submitted to SCDOT along with the preliminary or final bridge or road plan submittal. The review of the reports and plans will be performed in accordance with the submittal plan review process.

Three (3) copies of each report shall be provided to SCDOT. In addition, for each report, the Contractor shall provide a complete color copy of the signed and sealed report in PDF format to SCDOT. The CONTRACTOR shall also submit three (3) copies of each dynamic and/or static foundation load test report to SCDOT. After construction of the foundations is complete, the CONTRACTOR shall provide a supplement to the report containing the actual field conditions encountered and as-built foundation data and information.

# **EXHIBIT 4a**

## **ROADWAY DESIGN CRITERIA**

**Section 1**  
**INTENT OF DESIGN CRITERIA**

The CONTRACTOR will be expected to design and construct the project according to these design requirements.

Design criteria were established based on design speed, character and composition of traffic and width of right of way. These criteria were derived directly from the South Carolina Department of Transportation (SCDOT) Highway Design Manual and supplemented with AASHTO "A Policy on Geometric Design of Highways and Streets," 2001 Edition.

**Section 2**  
**DESIGN CRITERIA**

The terrain on all routes within the scope of work shall be classified as level. A WB-62 design vehicle shall be utilized for all geometric design except where otherwise noted.

Route	Design Speed	Functional Classification to be used for design
US 701	60 mph	Rural Arterial
Boat Ramp Access Road	25 mph	Local (Group 2)
All Side Roads	25 mph	Local (Group 2)

The typical section shown in Figure 1 should be used for the project. The CONTRACTOR shall provide a right turn lane and left turn lane from US 701 into the WNWR entrance road with minimum 200' of right turn and left turn storage. A S-BUS design vehicle shall be used for geometric design on the WNWR entrance road.



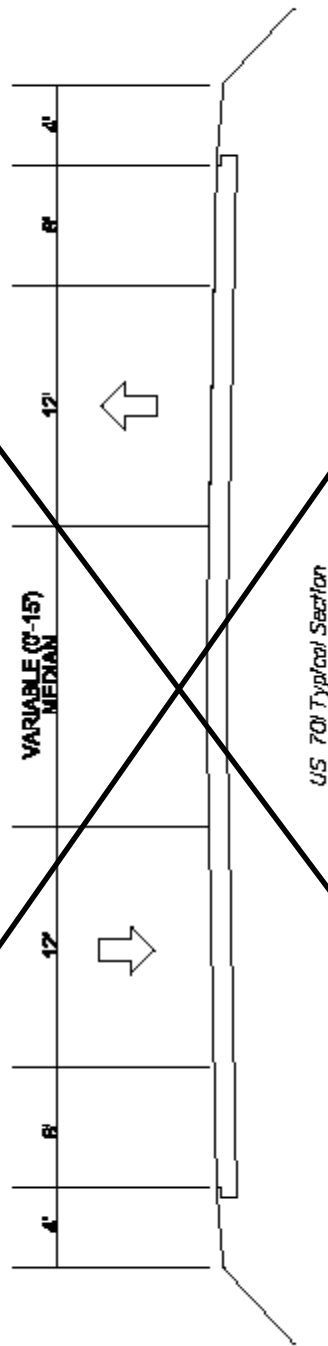

**Figure 1**

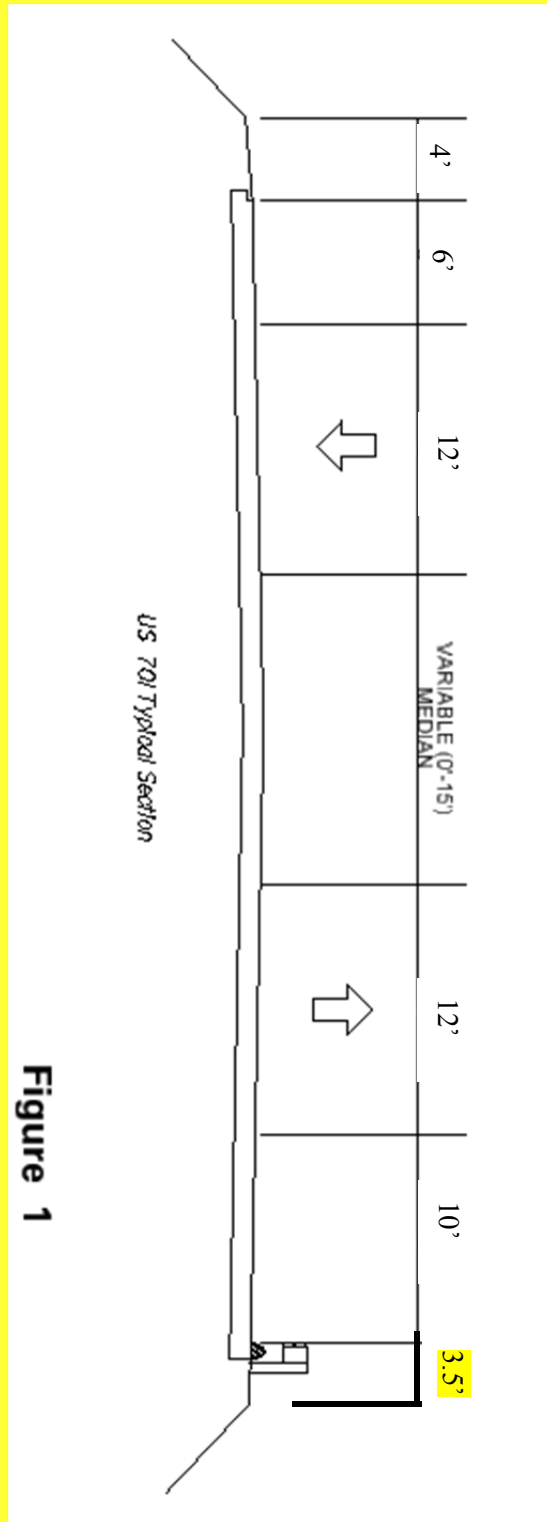

Figure 1

Note: Where guardrail is required, add 3.5' of additional unpaved shoulder width from the edge of pavement.

**Section 3  
PAVEMENT DESIGN**

The CONTRACTOR shall utilize the pavement designs outlined in **EXHIBIT 4c** during construction.

**Section 4  
RIGHT-OF-WAY AND CONTROL OF ACCESS**

**Right-of-way**

Right of Way shall be acquired in accordance with Section VIII of the Project Agreement.

**Minimum Widths Required**

The CONTRACTOR will be expected to design and secure right of way in accordance with these requirements. For existing right of way to be retained, the CONTRACTOR can retain the existing width.

<b>Route</b>	<b>Minimum Right of Way width</b>	<b>See footnotes for additional requirements</b>
US 701	Retain existing	Arterial

**Arterial** – Cover limits of improvement along route with minimum right of way width specified above. Design build team is allowed to secure necessary permissions for construction beyond minimum width. If permissions are not secured fee simple right of way shall be secured. Permanent drainage structures shall be covered with new Right-of-Way for future maintenance requirements.

**Bridge** – Secure right of way box to cover bridge area in accordance to chapter 12 section 11-Bridge Location of the Plan Preparation Guide using widths specified above.

Right of way lines should maintain uniform alignment for 300’ minimum and not fluctuate in and out.

**Section 5**

**CLEAR ZONE**

Utilize distances for clear zone as defined in the 2006 AASHTO Roadside Design Guide. 30' is a limit specified by AASHTO for practicality and consistency, but the actual clear zone requirements are greater in some cases, i.e., high speed/high ADT areas and the outside of curves (See pages 3-6 and 3-7 of AASHTO Roadside Design Guide).

**Section 6**

**SIDE SLOPES**

**FILL SLOPES** - The SCDOT Highway Design Manual; Chapters 13 and 19-22 will be used.

**Fill Section**

Height of Fill*	
≤ 5 ft	6:1
5 ft - 10 ft	4:1
≥10 ft	2:1

\* *CONTRACTOR shall utilize 2:1 fill slopes in wetland areas to minimize impacts.*

**CUT SLOPES**- The SCDOT Highway Design Manual, Chapter 13 & 14 will be used

**Ditch Section**

Shoulder (unpaved)	12:1
Shoulder (paved)	24:1
Fore Slope	6:1
Back Slope	6:1 to 2:1

**Section 7**

**SIGHT DISTANCE**

The SCDOT Highway Design Manual Chapter 10 – Sight Distance will be used.

The upper range value established in the current edition of AASHTO's "A Policy on Geometric Design of Highways and Streets," 2001, for the appropriate design speed will be used.

**Section 8**

**BOAT RAMP ACCESS ROAD (NEW LOCATION) AND BOAT RAMP DESIGN**

The CONTRACTOR shall provide a new roadway that ties to US 701 providing access to the new boat ramp facility. The below minimum criteria must be met for the Boat Ramp Access Road.

- Paved Travel Lane Width – 12’ (1 entry lane, 1 exit lane)
- Unpaved Shoulder Width – 6’
- Vertical Clearance (Local Road Under) – 16’
- Horizontal Curvature – 205’
- Radius Returns – 40’
- Angle of Intersection - 70°-90°
- Design Vehicle – Passenger Car with boat trailer

The 25’ minimum tangent distance shown in Figure 15.2C of the HDM between the PC and the intersection is waived for the public access road alignment.

The CONTRACTOR shall construct a new boat ramp facility at the Pee Dee River crossing in Horry County. The new ramp and parking area design shall meet all Department of Natural Resources Standard Construction Drawings shown in **Attachment B**. **The number of parking spaces shall be at least the amount that can fit within the footprint of the existing parking area along with appropriate maneuvering, tie-down, and make-ready lanes. The length and width of the dock and boat ramp shall be at least the same as existing.** The CONTRACTOR shall coordinate with the South Carolina Department of Natural Resources (SCDNR) and Horry County prior to any ramp or parking area constructions for final approval. Contact information is shown below:

Tim Vinson  
SCDNR, Engineering & Boating Access Div.  
1000 Assembly Street, Columbia, SC 29201  
Phone: (803) 206-2373  
Email: VinsonT@dnr.sc.gov

Andy Markunas, P.E., Deputy County Engr.  
Horry County Government, Engineering  
4401 Privetts Road, Conway, SC 29526  
Phone: (843) 915-5160  
Email: markunaa@horrycounty.org

EXHIBIT 4a – ROADWAY DESIGN CRITERIA

The ramp, access road, and parking area shall be shown and included as an integral part of the roadway design and roadway plans and detail sheets. The Port Harrelson Boat Ramp can be used as an alternate access during the construction of the new ramp facility.

# **EXHIBIT 4b**

## **STRUCTURES DESIGN CRITERIA**

## PROJECT SPECIFIC REQUIREMENTS

### Navigational Clearances

Clear horizontal navigational clearance of a minimum of 120 feet, measured from channel face of pier to channel face of pier.

The main channel span clear vertical navigation clearance shall be of no less than 40 feet vertical clearance above M.H.W. elevation 3.0 NAVD88 across the entire limits of horizontal clearance specified herein.

### Vessel Collision Analysis Criteria

#### 1. General Requirements

A vessel collision analysis shall be performed in accordance with Section 3.14 of AASHTO and AASHTO Vessel Collision Design of Highway Bridges, 2<sup>nd</sup> Edition, 2009, with 2010 Interim revisions.

The Method I Acceptance Criteria shall be used for the analysis and shall adhere to the Bridge Operational Classification of “Critical/Essential”.

Dynamic analysis techniques that take into account force-deformation, or other dynamic interaction, between the collision vessel and bridge structure during collision shall not be used.

**A fender system shall not be installed.**

#### 2. Collision Analysis

The vessel collision analysis shall, as a minimum, take into consideration the following two collision events:

Event 1 – Drifting empty barge impacting vulnerable bridge elements. The vessel impact loads shall be combined with one-half of the predicted long-term scour plus one-half of the predicted short-term scour. This event shall correspond with the 100-yr flood event.

Event 2 – Ship & Barge tow impacting vulnerable bridge elements while in transit. The vessel impact loads shall be combined with one-half of the predicted long-term scour, with no short-term scour. This event shall correspond to the MHW elevation 3.0 and yearly mean current.

The long-term and short-term scours shall be as defined in the AASHTO Vessel Collision Design of Highway Bridges Guide Specification.

Based on the channel vertical clearance that is being provided, superstructure vessel collision forces do not need to be considered.



### 3. Design Vessel

The design vessel shall be a single Small Deck Barge (45 ft x 120 ft) with an empty displacement of 250 tons. Draft when empty shall be assumed to be 1.50 ft.

In addition, the loaded barge shall have a maximum displacement tonnage of 400 tons. Draft when loaded shall be assumed to be 3.5 ft on the stern and 1.5 ft at the bow (rake). Assume the head log height to be 3 feet, the vessel depth to be 7 feet, the depth of bow to be 7 feet, and the bow rake length to be 10 feet.

Towboat shall be assumed to be a Harbor Boat (<600 horsepower) with a size of 20 ft x 50 ft. Towboat shall have an assumed draft of 6.5 ft and a gross displacement tonnage of 60 tons. Speed of combined vessels under power shall be assumed to be 6 knots, not including water velocity. Vessel impact speed may be distributed in accordance with the AASHTO Guide Specifications for Vessel Collision Design of Highway Bridges.

### Bridge Width

The minimum bridge width shall be 44' inside of the barriers such that the typical section shall provide for two (2) 12' travel lanes and two (2) 10' shoulders.

### Final Finish of Exposed Concrete Surfaces

~~No final surface finish is required.~~

The CONTRACTOR shall apply the final surface finish on the bridges to the following designated bridge areas:

- A) Entire surface of all barrier rails, parapet walls, approach slab curbs, concrete utility supports, and wing walls; outside vertical edge of bridge deck slabs and sidewalks.
- B) Outside face of exterior prestressed girders.
- C) Entire surface of all substructure units except top of bent caps and piers.

### Stay-in-place Bridge Deck Forms

Permanent stay-in-place steel bridge deck forms for concrete deck slabs may be used at the Contractor's option. Fillers shall not be used in the flutes of the stay-in-place forms. Form flutes shall be filled with concrete as the deck slab is placed.

### Bridge Decks

Bridge decks supported by girders or beams shall be reinforced cast-in-place concrete with reinforcing steel. All bridge decks shall comply with the rideability requirements of Subsection 702.4.14.1 of the Standard Specifications. The Contractor shall be responsible for coordinating with the SCDOT for scheduling the profilograph test, which is to be conducted by SCDOT.

### Grooved Surface Finish

A Grooved Surface Finish shall be applied to all concrete decks in accordance with Subsection 702.4.16 of the Standard Specifications for Highway Construction.

### Concrete Strengths

In prestressed concrete piles and beams, concrete strengths up to 8,000 and 10,000 psi maximum, respectively, may be used. All cast-in-place concrete bridge components shall be constructed with concrete having a minimum compressive strength of 4000 psi. All precast concrete bridge components shall be constructed with concrete having a minimum compressive strength of 5000 psi. **Lightweight concrete shall not be allowed as outlined in Section 15.2 of the *SCDOT Bridge Design Manual*.**

### Superstructure Types

For this project, Section 12.3.3 of the *SCDOT Bridge Design Manual* shall not be used. Allowable superstructure types are outlined in Sections 12.3.2.1, 12.3.2.2, 12.3.2.3 and 12.3.2.4 of the *SCDOT Bridge Design Manual*.

If prestressed concrete girders are used as outlined in Section 12.3.2.1 of *SCDOT Bridge Design Manual*, they shall be either I-beams or modified bulb-tee beams.

If structural steel girders or beams are used as outlined in Sections 12.3.2.3 or 12.3.2.4 of *SCDOT Bridge Design Manual*, they shall be "I" shaped.

Bridge deck overhangs shall follow Section 12.2.5.5 of the *SCDOT Bridge Design Manual*.

For both steel and concrete, deflections shall comply with Section 12.2.2 of the *SCDOT Bridge Design Manual*.

### **Substructures**

Interior Bents shall consist of cast-in-place reinforced concrete bent caps and columns supported on cast-in-place reinforced concrete drilled shafts or prestressed concrete pile footings. For footings not located in water, the top of footings shall be set at or below the natural ground elevation.

Interior Pile Bents shall consist of cast-in-place bent caps and a single row of vertical prestressed concrete piles. Interior Pile Bents shall have a sixty foot maximum spacing between bents.

Interior Pile Bents shall not be used for the US 701 Bridge over the Great Pee Dee River or the US 701 Bridge over Yauhannah Lake.

~~Interior Pile Bents shall not be used if debris is an issue, see BDM 20.3.5.~~

End abutment shall be spill through type abutments (2:1 maximum slope).

Bent caps may be sloped as outlined in Section 20.1.7 of *SCDOT Bridge Design Manual*.

### **Integral Interior Bent Caps**

If required on this Project, integral interior bent caps shall be constructed of concrete.

### **Foundation Design**

Bridge spread footings will not be permitted. Deep foundations are required to extend below any compacted fill.

**Pile Sizes and Types**

Minimum pile sizes and acceptable pile types are listed below. No other pile types will be permitted.

Pile Type	Minimum Size
Steel H-Piles	HP12x53
Steel Pipe Piles	12 inch diam. (min. wall thickness equal to ½ inch)
Prestressed Concrete Piles	18 inch square
Prestressed Concrete Pile Points	W8x58

**Dynamic Load Testing With Pile Driving Analyzer and Static Load Testing**

The CONTRACTOR will be responsible for dynamic and static load testing of all foundations if required by design. For Pile Driving Analysis (PDA) testing, the CONTRACTOR shall select a testing firm from those firms currently approved to provide foundation testing services on SCDOT’s foundation testing on-call contract. Load test reports shall bear the legible seal, date, and signature of the testing firm’s engineer, who shall be registered as a Professional Engineer in the State of South Carolina. The CONTRACTOR’S designer shall review and approve all load test reports prior to submitting the reports with his written approval to SCDOT for review and concurrence. The CONTRACTOR shall submit three copies of each report to SCDOT. SCDOT will review the load test reports and provide either concurrence or comments. Comments must be reviewed by the CONTRACTOR’S designer prior to resubmittal to SCDOT.

**Steel Pipe Pile Connection Details**

If the Contractor elects to utilize steel pipe piles, the pile connection detail described in Item 2 of Section 19.2.6.3 of the *SCDOT Bridge Design Manual* shall not be used for this Project. Steel pipe piles shall be terminated at the bottom of the cap or footing and the piles must be connected to the bent cap using a reinforced concrete infill, with the reinforcing extending into the cap or footing.

**Post Tensioning**

Grouting of post-tensioning ducts shall be performed within (7) days of post-tensioning. Specifications for all grout and conduit shall be submitted to SCDOT for approval prior to use. External post-tensioning and substructure post-tensioning shall not be used.

### **Cross-Hole Sonic Logging (CSL) Testing**

Cross-hole sonic logging (CSL) access tubes shall be installed in all drilled shafts in accordance with the *Standard Specifications for Highway Construction*. CSL testing will be conducted by SCDOT on all of the shafts.

### **Barrier Parapets**

The SCDOT 32-in concrete bridge barrier parapet with bicycle railing to 42-in height shall be used. See Item #1 in Section 17.6.3 of the Bridge Design Manual along with DM0113. The SCDOT Standard Barrier parapet Transition shall be used at all barrier ends where a three beam guardrail bridge connector is required.

### **Slope Protection**

Provide slope protection for the bridge end fills. The end fills at the ends of the bridge shall be protected with rip rap in accordance with Standard Drawing 804-105-00.

### **Longitudinal Restrainers**

If longitudinal joint restrainers are used, they shall be considered secondary and minimum support lengths shall be provided in accordance with the *SCDOT Seismic Design Specifications for Highway Bridges*.

### **Navigational Lighting**

Navigational Lighting is not required. ~~If required in stipulations of the USCG Bridge Permit, Navigation Lighting shall be installed provided on the channel span as per AASHTO and USCG standards. See special provision titled *Navigation Lights for Bridge* in **Exhibit 5** for additional requirements.~~

### **Navigational Channel**

No obstructions are allowed in the navigational channel. The navigational channel is shown in the 1996 bridge repair plans (File number 22.5696.1) and is between Piers E-E and F-F. Any variation in the location of the navigational channel is subject to USCG approval. Existing horizontal clearance must be maintained at the channel during construction to accommodate marine traffic.

### Operational Classification

The Operational Classifications are provided in ~~EXHIBIT 4f~~. In accordance with the Seismic Design Specifications for Highway Bridges, the Bridge Operational Classification (OC) shall be “I.”

### Bridge Deck Drainage

Any necessary bridge deck drainage in the form of “off-bridge” inlet protection and “on-bridge” scuppers shall be provided. A closed drainage system will be required and the bridge drainage shall be designed in accordance with SCDOT requirements. Scuppers shall be connected to under deck collector pipes and the runoff shall be treated in accordance with Exhibit 4e, Hydraulic Design Criteria.

The appropriate design method shall be utilized depending on selection of rectangular or circular scuppers with downspouts. The scuppers shall be designed in a manner that allows integration into the bridge deck design and does not interfere with structural continuity. Surface grates and recessed collection chambers may be considered if structurally necessary. Inlets are to be sized as large as possible to allow for ease of maintenance. Inlet grates shall be designed for safe passage of bicycle traffic. Scuppers shall be a minimum of six inches in diameter (or equivalent cross sectional area).

Downspouts and collector pipes shall be fiberglass and shall be colored (not painted) to match the finished bridge color (Federal Color Standard No. 26600). Cleanouts shall be provided. No drains or discharge pipes shall be allowed inside of structural elements other than the bridge deck.

As a minimum, concrete flumes shall be provided at the end of the approach slabs as required to prevent erosion of the bridge fill slope. Alternative drainage structures such as roadway catch basins shall be provided where concrete flumes interfere with the closed system. Storm drainage pipes shall not be permitted under the approach slabs.

# **EXHIBIT 4c**

## **PAVEMENT DESIGN CRITERIA**

EXHIBIT 4c – PAVEMENT DESIGN CRITERIA

The CONTRACTOR shall utilize the following pavement designs during construction.

US 701

**Existing Mainline Pavement:** Mill the existing pavement 2 inches and overlay with 200 psy HMA Surface Type B where indicated

**New Location Pavement:** The following pavement structures are acceptable for pavement on new location. These alternatives may be used within the project as desired at the option of the contractor.

Full Depth HMA:

200 psy HMA Surface Type B

200 psy HMA Intermediate Type B

900 psy HMA Base Type A

Graded Aggregate Base:

200 psy HMA Surface Type B

200 psy HMA Intermediate Type B

350 psy HMA Base Type A

10 inches Graded Aggregate Base

Cement Stabilized Aggregate Base:

200 psy HMA Surface Type B

200 psy HMA Intermediate Type B

9 inches Cement Stabilized Aggregate Base

Boat Ramp Access & Parking Area, Sideroads, and WNWR entrance

Existing Pavement: Apply Tack Coat in accordance with Standard Specifications then overlay with 200 psy HMA Surface Type B.

New Construction:

200 psy HMA Surface Type B

8 inches Graded Aggregate Base

Or

200 psy HMA Surface Type B

200 psy HMA Intermediate Type B

400 psy HMA Base Type A



# **EXHIBIT 4d - Part 1**

## **SIGNING AND PAVEMENT MARKING DESIGN CRITERIA**

**(1) GENERAL PROVISIONS FOR PERMANENT PAVEMENT MARKINGS:**

Pavement marking work on this project consists of preparing detailed pavement marking plans and providing and applying appropriate markings for the length of the project. All edge lines, lane lines, channelization markings, stopbars and word messages and symbols on US 701 and all intersecting routes shall be of the width and patterns detailed in the Standard Drawings. The white edge lines may be 6 inches in width if sufficient shoulder width is present to allow for bicycle traffic. The final roadway surface material will determine which type of permanent marking material is to be applied. The Contractor shall use preformed tape (T-1) markings on all concrete bridge deck surfaces. Thermoplastic markings shall be used on all asphalt surfaces.

All work involved in this contract shall be in accordance with the following publications:

- The South Carolina “Standard Specifications for Highway Construction”, (latest edition) – referred to as the Standard Specifications
- The South Carolina “Standard Drawings for Road Construction”, (latest edition) – referred to as the Standard Drawings
- The Federal “Manual on Uniform Traffic Control Devices”, (latest edition) – referred to as the MUTCD.
- The Plans and these Special Provisions.

Pavement marking materials used shall meet the following requirements:

**1. THERMOPLASTIC PAVEMENT MARKINGS (ASPHALT SURFACES):**

All thermoplastic markings installed on the interstate mainline or any crossing routes shall meet the requirement of Section 627 of the Standard Specifications.

**2. PREFORMED PATTERNED TAPE (T-1) PAVEMENT MARKINGS (CONCRETE SURFACES):**

The markings applied to the concrete bridge decks on this project shall be pre-formed patterned tape with a raised diamond pattern covered with ceramic elements having a refractive index of 1.9 or greater. These markings shall be installed with a truck mounted application system or other motorized applicator approved by the manufacturer.

The Contractor shall provide to the Department the manufacturer’s normal warranty which shall guarantee the tape materials for a period of 72 months from the date of installation from failure to retain the minimum reflectance values provided by the manufacturer and from failure due to loss of material adhesion or complete wear through. If failure occurs, the manufacturer will provide the replacement materials to restore the markings to their original effectiveness.

**(2) GENERAL PROVISIONS FOR PERMANENT SIGNING:**

Signing work on this project consists of preparing detailed signing plans; and fabricating, furnishing, and erecting new ground mounted guide, regulatory and warning signs. New signs shall be erected over the entire length of the project, including, at a minimum, stop signs on all intersecting routes. Existing signs, if applicable, shall be maintained during construction.

Development of the signing plans should be coordinated through the District Traffic Engineer for Engineering District 5. The District Traffic Engineer shall have final approval of all signing plans.

All work involved in this contract shall be in accordance with the following publications:

- The South Carolina “Standard Specifications for Highway Construction”, (latest edition) – referred to as the Standard Specifications
- The South Carolina “Standard Drawings for Road Construction”, (latest edition) – referred to as the Standard Drawings
- The Federal “Manual on Uniform Traffic Control Devices”, (latest edition) – referred to as the MUTCD.
- The AASHTO “Standard Specifications for Structural Supports for Highway Signs, Luminaires and Traffic Signals”, (latest edition)
- The Plans and these Special Provisions.

## **EXHIBIT 4d - Part 2**

# **WORK ZONE TRAFFIC CONTROL DESIGN CRITERIA**

**TRAFFIC CONTROL**

The Contractor shall execute the item of Traffic Control as required by the Standard Specifications, the plans, the Standard Drawings For Road Construction, these special provisions, all supplemental specifications, the MUTCD, and the Engineer. This is an amendment to the Standard Specifications to require the following:

**GENERAL REGULATIONS**

These special provisions shall have priority to the plans and comply with the requirements of the MUTCD and the standard specifications. Revisions to the traffic control plan through modifications of the special provisions and the plans shall require approval by the department. Final acceptance of any revisions to the traffic control plan shall be pending upon review by the member of the Design-Build team representing the Director of Traffic Engineering through the Design-Review Process.

Install and utilize changeable message signs in all lane closures installed on high volume high-speed multilane roadways. Use of changeable message signs in lane closures installed on low volume low speed multilane roadways is optional unless otherwise directed by the plans and the Engineer. Install and use a changeable message sign within a lane closure set-up as directed by the *Standard Drawings For Road Construction*. When a lane closures is not present for any time to exceed 24 hours, remove the changeable message sign from the roadway. Place the sign in a predetermined area on the project site, as approved by the Engineer, where the sign is not visible to passing motorists. Utilize preprogrammed messages in accordance with the *Standard Drawings For Road Construction* when using the changeable message sign as part of the traffic control set-up for lane closures. Only those messages pertinent to the requirements of the traffic control situation and the traffic conditions are permitted for display on a changeable message sign at all times. At no time will the messages displayed on a changeable message sign duplicate the legends on the permanent construction signs.

During operation of changeable message signs, place the changeable message sign on the shoulder of the roadway no closer than 6 feet between the sign and the near edge of the adjacent travel lane. When the sign location is within 30’ of the near edge of a travel lane open to traffic, supplement the sign location with no less than 5 portable plastic drums placed between the sign and the adjacent travel lane for delineation of the sign location. Install and maintain the drums no closer than 3 feet from the near edge of the adjacent travel lane. This requirement for delineation of the sign location shall apply during all times the sign location is within 30’ of the near edge of a travel lane open to traffic, including times of operation and non-operation. Oversized cones are prohibited as a substitute for the portable plastic drums during this application.

All signs mounted on portable sign supports shall have a minimum mounting height of 5’ from the bottom of the sign to the ground. All signs mounted on ground mounted u-channel posts or square steel tube posts shall have a minimum mounting height of 7’ from the bottom of the sign to the grade elevation of the near edge of the adjacent travel lane or sidewalk when a sidewalk is present.

EXHIBIT 4D – PART 2 WORK ZONE TRAFFIC CONTROL REQUIREMENTS

On multilane primary routes, avoid placement of signs mounted on portable sign supports within paved median areas utilized for two-way left turns unless otherwise directed by the RCE.

Temporary “Exit” signs (M1025-00) shall be located within each temporary gore during lane closures on multilane roadways. Mount these signs a minimum of 7’ from the pavement surface to the bottom of the sign in accordance with the requirements of the MUTCD.

When mounting signs on ground mounted u-section or square steel tube posts, utilize either a sign support / ground support post combination with an approved breakaway assembly or a single direct driven post for each individual sign support of a sign assembly installation. Do not combine a sign support / ground support post combination and a direct driven post on the same sign assembly installation that contains two or more sign supports. Regarding sign support / ground support post combination installations, ensure that post lengths, stub heights and breakaway assemblies comply with the manufacturer’s requirements and specifications. Use approved breakaway assemblies found on the *Approved Products List For Traffic Control Devices in Work Zones*.

When covering signs with opaque materials, the Department prohibits attaching a covering material to the face of the sign with tape or a similar product or any method that will leave a residue on the retroreflective sheeting. Residue from tape or similar products, as well as many methods utilized to remove such residue, damages the effective reflectivity of the sign. Therefore, contact of tape or a similar product with the retroreflective sheeting will require replacement of the sign. Cost for replacement of a sign damaged by improper covering methods will be considered incidental to providing and maintaining the sign; no additional payment will be made.

Overlays are prohibited on all rigid construction signs. The legends and borders on all rigid construction signs shall be either reversed screened or direct **applied**.

Signs not illustrated on the typical traffic control standard drawings designated for permanent construction signs shall be considered temporary and shall be included in the lump sum price bid item for “Traffic Control” unless otherwise specified.

Install “Grooved Pavement” signs (W8-15-48) supplemented with the “Motorcycle” plaque (W8-15P-30) in advance of milled or surface planed pavement surfaces. On primary routes, install these signs no further than 500 feet in advance of the beginning of the pavement condition. On interstate routes, install these signs no less than 500 feet in advance of the beginning of the pavement condition. Install two sign assemblies at each sign location, one on each side of the roadway, on multilane roadways when the pavement condition is present. Install these signs immediately upon creation of this pavement condition and maintain these signs until this pavement condition is eliminated.

Install “Steel Plate Ahead” signs (W8-24-48) in advance of an area of roadway where temporary steel plates are present. Install these signs no further than 300 feet in advance of locations where steel plates are present. On multilane roadways, comply with the same

**EXHIBIT 4D – PART 2 WORK ZONE TRAFFIC CONTROL REQUIREMENTS**

guidelines as applied to all other advance warning signs and install two sign assemblies at each sign location, one on each side of the roadway, when roadway conditions warrant. Install these signs immediately upon installation of a temporary steel plate and maintain the signs until the temporary steel plates are removed.

Install and maintain any necessary detour signing as specified by the typical traffic control standard drawings designated for detour signing, Part VI of the MUTCD, these Special Provisions, and the Engineer. The lump sum price bid item for “Traffic Control” includes payment for installation and maintenance of the detour signing.

The Contractor shall maintain the travel patterns as directed by the traffic control plans and shall execute construction schedules expeditiously. The Contractor shall provide the Resident Engineer with no less than a two-week prior notification of changes in traffic patterns.

During nighttime flagging operations, flaggers shall wear a safety vest and safety pants that comply with the requirements of ANSI / ISEA 107 standard performance for Class 3 risk exposure, latest revision, and a fluorescent hard hat. The safety vest and the safety pants shall be retroreflectorized and the color of the background material of the safety vest and safety pants shall be fluorescent orange-red or fluorescent yellow-green.

During nighttime flagging operations, the contractor shall illuminate each flagger station with any combination of portable lights, standard electric lights, existing street lights, etc., that will provide a minimum illumination level of 108 Lx or 10 fc.

During nighttime flagging operations, supplement the array of advance warning signs with a changeable message sign for each approach. These changeable message signs are not required during daytime flagging operations. Install the changeable message signs 500’ in advance of the advance warning sign arrays. Messages should be “Flagger Ahead” and “Prepare To Stop”.

During the paving operations, the length of roadway with an acceptable grade elevation difference less than or equal to 2" shall be restricted to 4 miles.

During the milling and surface planing operations, the length of roadway with an acceptable grade elevation difference less than or equal to 1" shall be restricted to 4 miles.

During construction on the ramps, the contractor shall conduct flagging operations. The flagging operations shall either stop traffic or direct the traffic around the work area. Installation and operation of these flagging operations shall be according to these special provisions and the MUTCD.

Supplement and delineate the shoulder edges of travel lanes through work zones with traffic control devices to provide motorists with a clear and positive travel path. Utilize portable plastic drums unless otherwise directed by the Department. Vertical panels may be used where specified by the plans and directed by the RCE. The installation of traffic control devices are required in all areas where those areas immediately adjacent to a travel lane open to traffic have been altered in any manner by work activities, including but not limited to activities such as

grading, milling, etc. Install the traffic control devices immediately upon initiating any alterations to the areas immediately adjacent to or within 15 feet of the near edge line of the adjacent travel lane. When sufficient space is available, place the traffic control devices no closer than 3 feet from the near edge of the traffic control device to the near edge line on the adjacent travel lane. When sufficient space is unavailable, place the traffic control device at the maximum distance from the near edge of the adjacent travel lane available.

Provide changeable message signs, visible by road and water, to issue notice to boat launch ramp users during the closure of the water access.

### **LANE CLOSURE RESTRICTIONS**

The lane closure restrictions stated below are project specific, for all other restrictions, see supplemental specification, “Restrictions”, dated January 3, 2013.

The Department prohibits lane closures on US 701 Monday through Friday from 7:00 am to 7:00 pm.

The Contractor shall install all lane closures as directed by the 2007 Standard Specifications For Highway Construction, the Standard Drawings For Road Construction, these special provisions, the MUTCD, and the Engineer. The Contractor shall close the travel lanes of two-lane two-way roadways by installing flagging operations. The Contractor shall close the travel lanes of multilane roadways as directed by the typical traffic control standard drawings designated for lane closures on primary routes.

~~The Department prohibits lane closures on primary routes during any time of the day that traffic volumes exceed 800 vehicles per hour per direction. The Department reserves the right to suspend a lane closure if any resulting traffic backups are deemed excessive by the Engineer. Maintain all lane closure restrictions as directed by the plans, these special provisions, and the Engineer.~~

Flagging operations are considered to be lane closures for two-lane two-way operations and shall be subject to all restrictions for lane closures as specified by this contract.

Lane closures, including flagging operations, are restricted to maximum distances of 2 miles. Install all lane closures according to the typical traffic control standard drawings. On occasions when daytime lane closures must be extended into the nighttime hours, substitute the nighttime lane closure standards for the daytime lane closure standards.

The Department reserves the right to suspend a lane closure if any resulting traffic backups are deemed excessive by the Engineer. Maintain all lane closure restrictions as directed by the Standard Specifications, these special provisions, and the Engineer.

Installation and maintenance of a lane closure is PROHIBITED when the Contractor is not actively engaged in work activities specific to the location of the lane closure unless otherwise specified and approved by the Engineer. The length of the lane closure shall not



exceed the length of roadway anticipated to be subjected to the proposed work activities within the work shift time frame or the maximum lane closure length specified unless otherwise approved by the Engineer. Also, the maximum lane closure length specified does not warrant installation of the specified lane closure length when the length of the lane closure necessary for conducting the work activity is less. The length and duration of each lane closure, within the specified parameters, shall require approval by the Engineer prior to installation. The length and duration of each lane closure may be reduced by the Engineer if the work zone impacts generated by a lane closure are deemed excessive or unnecessary.

The presence of temporary signs, portable sign supports, traffic control devices, trailer mounted equipment, truck mounted equipment, vehicles and vehicles with trailers relative to the installation or removal of a closure and personnel are prohibited within the 15 to 30 foot clear zone based upon the roadway speed limit during the prohibitive hours for lane closures specified by these special provisions.

**SHOULDER CLOSURE RESTRICTIONS**

The Department prohibits the Contractor from conducting work within 15’ of the near edge of the adjacent travel lane on the outside shoulders or the median areas under a shoulder closure during any time of the day that traffic volumes exceed 800 vehicles per hour per direction. The hourly restrictions for lane closures shall also apply to work activities conducted under a shoulder closure within 15’ of the near edge of an adjacent travel lane or a median area. The Department reserves the right to suspend work conducted under a shoulder closure if any traffic backups develop and are deemed excessive by the Engineer. Maintain all shoulder closure restrictions as directed by the plans, these special provisions, and the Engineer.

On primary and secondary roadways, the Department prohibits the Contractor from conducting work within 1’ or less of the near edge of an adjacent travel lane under a shoulder closure. All work that may require the presence of personnel, tools, equipment, materials, vehicles, etc., within 1’ of the near edge of an adjacent travel lane shall be conducted under a lane closure.

The Contractor shall install all shoulder closures as directed by the typical traffic control standard drawings designated for shoulder closures, and the Engineer. Substitution of the portable plastic drums with oversized cones during nighttime shoulder closures is PROHIBITED.

**TYPICAL TRAFFIC CONTROL STANDARD DRAWINGS**

The typical traffic control standard drawings of the “Standard Drawings For Road Construction”, although compliant with the MUTCD, shall take precedence over the MUTCD. The typical traffic control standard drawings of the “Standard Drawings For Road Construction” shall apply to all projects let to contract.

**ADDENDUMS**

(Addendums to the “2007 Standard Specifications for Highway Construction”)

**(A) Construction (Sub-section 601.4)**

**Sub-section 601.4.2 Construction Vehicles (paragraph 2)**

When working within the rights-of-way of access-controlled roadways such as Interstate highways, the Contractor’s vehicles may only change direction of travel at interchanges. These vehicles are prohibited from crossing the roadway from right side to median or vice versa. Use a flagger to control the Contractor’s vehicles when these vehicles attempt to enter the roadway from a closed lane or the median area. Ensure that the flagger does not stop traffic, cause traffic to change lanes, or affect traffic in any manner. The Contractor’s vehicles may not disrupt the normal flow of traffic or enter the travel lane of the roadway until a sufficient gap is present.

The Contractor shall have flaggers available to control all construction vehicles entering or crossing the travel lanes of secondary and primary routes. The RCE shall determine the necessity of these flaggers for control of these construction vehicles. The RCE shall consider sight distance, vertical and horizontal curves of the roadway, prevailing speeds of traffic, frequency of construction vehicles entering or crossing the roadway, and other site conditions that may impact the safety of the workers and motorists when determining the necessity of these flaggers. Ensure that these flaggers do not stop traffic, cause traffic to change lanes, or affect traffic in any manner. The Contractor’s vehicles may not disrupt the normal flow of traffic or enter the travel lane of the roadway until a sufficient gap is present.

**(B) Construction (Sub-section 601.4)**

**Sub-section 601.4.2 Construction Vehicles**

**Auxiliary Warning Lights for Vehicles and Equipment**

Supplement all construction and/or construction-related vehicles and equipment that operate in a stationary or mobile work zone within or adjacent to a roadway within the highway rights-of-way with AMBER or YELLOW colored high intensity rotating or strobe type flashing auxiliary warning light devices. Utilize, install, operate and maintain a single or multiple lighting devices as necessary to provide visibility to approaching motorists.

All auxiliary warning light models shall meet *Society of Automotive Engineers* (SAE) Class I standards and SAE Standard J575 relative to *Tests for Motor Vehicle Lighting Devices and Components* and these specifications.

The amber/yellow color of the dome/lens of an auxiliary warning light device shall meet SAE Standard J578 for amber/yellow color specifications.

Auxiliary warning lights with parabolic reflectors that rotate shall rotate around a halogen lamp at a rate to produce approximately 175 flashes per minute. The parabolic reflector shall produce a minimum 80,000 candle power and a minimum 54,000 candela through an SAE Standard J846 approved amber dome.

Equip strobe type flashing auxiliary warning light devices with photosensitive circuit controls to adjust the lighting intensity in response to changes in ambient light conditions such as from day to night. These lights shall have a double-flash capability rated at approximately 80 double flashes per minute and produce a minimum 24 joules of flash energy at the highest power level setting.

Acceptable auxiliary warning light models shall provide sufficient light output to be clearly recognizable at a minimum distance of 1750 feet.

Mount all auxiliary warning light devices intended to function as the auxiliary warning light system or as an element thereof on vehicles and equipment at locations no less than 3 feet above the ground and in conspicuous locations to provide visibility to approaching motorists.

Auxiliary warning light devices and/or models that mount in the locations of the standard vehicle lighting system are unacceptable as the specified auxiliary warning light system due to restrictive simultaneous visibility capabilities from multiple sight angles. However, auxiliary warning light devices that mount in the standard vehicle lighting system locations are acceptable as supplements to the specified lighting devices mounted in locations that do meet the minimum height requirements and provide simultaneous visibility capabilities from multiple sight angles.

Standard vehicle hazard warning lights are only permitted as supplements to the specified auxiliary warning light devices.

(C) **Category I Traffic Control Devices (Section 603)**

\*\*\* *(Effective on all projects let to contract after May 1, 2010)* \*\*\*

**Sub-section 603.2.2 Oversized Traffic Cones (paragraph 6)**

Reflectorize each oversized traffic cone with 4 retroreflective bands: 2 orange and 2 white retroreflective bands. Alternate the orange and white retroreflective bands, with the top band always being orange. Make each retroreflective band not less than 6 inches wide. Utilize Type III – Microprismatic retroreflective sheeting for retroreflectorization on all projects let to contract after May 1, 2010 unless otherwise specified. Separate each retroreflective band with not more than a 2-inch non-reflectorized area. Do not splice the retroreflective sheeting to create the 6-inch retroreflective bands. Apply the retroreflective sheeting directly to the cone surface. Do not apply the retroreflective sheeting over a pre-existing layer of retroreflective sheeting.

**Sub-section 603.2.3 Portable Plastic Drums (paragraph 3)**

Reflectorize each drum with Type III – Microprismatic retroreflective sheeting: 2 orange and 2 white retroreflective bands, 6 inches wide on all projects let to contract after May 1, 2010 unless otherwise specified. Alternate the orange and white retroreflective bands with the top band always being orange. Ensure that any non-reflectorized area between the orange and white retroreflective bands does not exceed 2 inches. Do not splice the retroreflective sheeting to create the 6-inch retroreflective bands. Apply the retroreflective sheeting directly to the drum surface. Do not apply the retroreflective sheeting over a pre-existing layer of retroreflective sheeting.

**(D) Category II Traffic Control Devices (Section 604)**

\*\*\* *(Effective on all projects let to contract after May 1, 2012)* \*\*\*

**Sub-section 604.2.1 Type I and Type II Barricades (paragraph 3)**

Reflectorize these barricades with Type VIII or IX Prismatic retroreflective sheeting on all projects let to contract after May 1, 2012 unless otherwise specified. Ensure that the retroreflective sheeting has alternate orange and white stripes sloping downward at a 45-degree angle in the direction of passing traffic. The stripes shall be 6 inches wide.

**Sub-section 604.2.2 Type III Barricades (paragraph 3)**

Reflectorize these barricades with Type VIII or IX Prismatic retroreflective sheeting on all projects let to contract after May 1, 2012 unless otherwise specified. Ensure that the retroreflective sheeting has alternate orange and white stripes sloping downward at a 45-degree angle. Apply the sloping orange and white stripes in accordance with the requirements of the Plans, SCDOT Standard Drawings and the MUTCD. The stripes shall be 6 inches wide.

**(E) Temporary Concrete Barrier (Sub-section 605.2.3.2)****Sub-section 605.2.3.2 Temporary Concrete Barrier (paragraph 6)**

Previously used temporary concrete barrier walls are subject to inspection and approval by the RCE before use. Ensure that previously used temporary concrete barrier walls are in good condition. Defects to a temporary concrete barrier wall that may disqualify a section of wall for use include gouges, cracks, chipped, or spalled areas. A defect that exposes reinforcing steel warrants immediate disqualification. A disqualification grade type defect shall consist of measurements in excess of 1 inch, entirely or partially within the boundaries of the end connection areas and the drainage slot areas as illustrated in the “Standard Drawings for Road Construction”, and/or in excess of 4 inches for all areas beyond the end connection areas. To warrant disqualification, these measurements shall exceed the specified dimensions in all three

directions, width, height, and depth. A defect that exceeds the specified dimensions in only one or two of the three directions does not warrant disqualification.

Temporary concrete barrier walls with defects less than 6 inches in all three directions, width, height, and depth that do not expose reinforcing steel may be repaired in accordance with the following requirements. Repair is prohibited on temporary concrete barrier walls with defects 6 inches or greater in all three directions, width, height, and depth.

For repair of temporary concrete barrier walls with defects less than 6 inches in all three directions, width, height, and depth that do not expose reinforcing steel, repair the defect with a premanufactured patching material specifically fabricated for patching structural concrete. The strength of the patch must meet or exceed the design strength of the class 3000 concrete of the temporary concrete barrier wall. Perform the repair procedures in accordance with all requirements and instructions from the manufacturer of the patch material. Use a bonding compound between the patch material and the concrete unless specifically stated by the manufacturer that a bonding compound is not required. If the manufacturer states that application of a bonding compound is optional, SCDOT requires application of a bonding compound compatible with the patch material. If cracking occurs within the patched area, remove the patch material completely and repeat the repair process. The contractor shall submit documentation stating all repairs have been conducted in accordance with these requirements prior to installing any temporary concrete barrier walls with repairs. Utilization of temporary concrete barrier walls with repairs shall require approval by the RCE prior to installation.

The Contractor shall submit certification documents for the patch material utilized for repairs to the Engineer prior to placing temporary concrete barrier walls that have been repaired on the project site.

**(F) Truck-Mounted Attenuator (Sub-section 605.4.2.2)**

**Sub-section 605.2.2.2.3.3 Color (paragraph 1)**

Use industrial grade enamel paint for cover of the metal aspects of the unit. Provide and attach supplemental striping to the rear face of the unit with a minimum Type III high intensity retroreflective sheeting unless otherwise directed by the Department. Utilize an alternating 4 to 8 inch black and 4 to 8 inch yellow 45-degree striping pattern that forms an inverted “V” at the center of the unit that slopes down and to the sides of the unit in both directions from the center.

**(G) Truck-Mounted Attenuator (Sub-section 605.4.2.2)**

**Sub-section 605.4.2.2 Truck-Mounted Attenuators (paragraph 6)**

Attach each truck-mounted attenuator to the rear of a truck with a minimum gross vehicular weight (GVW) of 15,000 pounds (actual weight). If the addition of supplemental weight to the vehicle as ballast is necessary, contain the material within a structure constructed of steel. Construct this steel structure to have a minimum of four sides and a bottom to contain the

ballast material in its entirety. A top is optional. Bolt this structure to the frame of the truck. Utilize a sufficient number of fasteners for attachment of the steel structure to the frame of the truck to ensure the structure will not part from the frame of the truck during an impact upon the attached truck mounted attenuator. Utilize either dry loose sand or steel reinforced concrete for ballast material within the steel structure to achieve the necessary weight. The ballast material shall remain contained within the confines of the steel structure and shall not protrude from the steel structure in any manner.

**(H) Trailer-Mounted Changeable Message Signs (Sub-section 606.3.2)**

**Sub-section 606.5 Measurement (paragraph 2)**

Trailer-mounted changeable message signs are included in the lump sum item for Traffic Control in accordance with **Subsections 107.12** and **601.5** of the “2007 Standard Specifications for Highway Construction”. No separate measurement will be made for trailer-mounted changeable message signs unless the contract includes a specific pay item for trailer-mounted changeable message signs.

The Contractor shall provide, install, operate, and maintain the trailer-mounted changeable message sign per traffic control set-up as directed by the Plans, the “Standard Drawings for Road Construction”, these Special Provisions, the Specifications, and the Engineer.

**Sub-section 606.6 Payment (paragraph 2)**

In addition to **Subsections 107.12** and **601.6**, the payment for Traffic Control is full compensation for providing, installing, removing, relocating, operating, and maintaining trailer-mounted advance warning arrow panels and trailer-mounted changeable message signs as specified or directed and includes providing the units’ primary power source; repairing or replacing damaged or malfunctioning units within the specified time; providing traffic control necessary for installing, operating, and maintaining the units; and all other materials, labor, hardware, equipment, tools, supplies, transportation, incidentals, and any miscellaneous items necessary to fulfill the requirements of the pay item in accordance with the Plans, the Specifications, and other items of the Contract.

**Sub-section 606.6 Payment (paragraph 3)**

Disregard this paragraph unless the Contract includes a specific pay item for trailer-mounted changeable message signs.

**(I) Flagging Operations (Sub-section 610.4.1)**

**Sub-section 610.4.1.1 Flagging Operations (paragraph 1)**

Use a flagging operation to control the flow of traffic when two opposing directions of traffic must share a common travel lane. A flagging operation may be necessary during a lane closure on a two-lane two-way roadway, an intermittent ramp closure or an intermittent encroachment of equipment onto a portion of the roadway. Utilize flagging operations to direct traffic around work activities and maintain continuous traffic flow at reduced speeds when determined to be appropriate by the RCE. As stated above, flagging operations shall direct traffic around the work activities and maintain continuous traffic flow; therefore, stopped traffic shall not be required to stop for time durations greater than those listed below unless otherwise directed by the RCE.

<b>LENGTH OF CLOSURE</b>	<b>MAXIMUM TIME DURATION FOR STOPPED TRAFFIC</b>
<b>1 MILE or LESS</b>	5 Minutes
<b>1 to 2 MILES</b>	7 ½ Minutes

If the work activities require traffic to be stopped for periods greater than 5 to 7 ½ minutes as stated above, consider alternate work methods, conducting work activities during times of lowest traffic volumes such as during the hours of darkness or complete road closure with detour installation.

**(J) Paving and Resurfacing (Sub-section 611.4.1)**

**Sub-section 611.4.1.2 Requirements (paragraph 8)**

Whenever travel lanes with acceptable grade elevation differences are open to traffic, provide “Uneven Lanes” signs (W8-11-48) or “Uneven Pavement” signs (W8-11A-48). Reflectinize these signs with a fluorescent orange colored prismatic retroreflective sheeting unless otherwise specified. Install these signs adjacent to roadways with uneven pavement surfaces between travel lanes or between travel lanes and the adjacent paved shoulders. Install these signs at intervals no greater than 2600 feet.

**STAGING**

**TRAFFIC CONTROL RESTRICTIONS (Project Specific)**

The presence of acceptable grade elevation differences less or equal to 1” in milled areas or less than or equal to 2” in paved areas adjacent to a travel lane open to traffic are prohibited during weekends from 8:00 am Friday to 9:00 pm Sunday unless otherwise directed by the Engineer. When necessary, the weekend restriction may be extended due to the proximity of a holiday as directed by the Engineer.

During surface planing and milling operations, the length of roadway with a milled surface open to traffic is restricted to 4 miles. This restriction does not apply to concrete diamond grinding operations.

During surface planing and milling operations, the length of roadway with an acceptable grade elevation difference less than or equal to 1” adjacent to a single travel lane or between multiple travel lanes open to traffic is restricted to a maximum distance of 4 miles.

During asphalt paving operations, the Contractor may conduct these work activities under lane closures with lengths up to but not greater than 4 miles. The Contractor shall comply with the 2 mile length restriction for lane closures for all work activities other than the asphalt paving operations.

During asphalt paving operations, the length of roadway with an acceptable grade elevation difference less than or equal to 2" adjacent to a single travel lane or between multiple travel lanes open to traffic is restricted to a maximum distance of 4 miles.

The Contractor may conduct various work activities in the same direction at various locations concurrently if approved by the Engineer. Various work activities in the same direction requiring simultaneous closures in the same travel lane or shoulder shall be separated by no less than 2 miles from the end of the first closure that a motorist will encounter to the beginning of the taper of the second closure. Also, various work activities in the same direction requiring simultaneous right and left lane closures or shoulder closures shall be separated by no less than 4 miles from the end of the first closure that a motorist will encounter to the beginning of the taper of the second closure.



# **EXHIBIT 4e**

## **HYDRAULIC DESIGN CRITERIA**

**a) HYDROLOGY AND HYDRAULIC DESIGN**

The CONTRACTOR will develop hydrologic and hydraulic designs for the bridge and follow all guidelines for roadway surface drainage and sediment and erosion control with the methods, procedures, and criteria outlined in the “SCDOT Requirements for Hydraulic Design Studies”, May 26, 2009, and all pertinent Design References located in Exhibit 4, Project Design Criteria.

At a minimum, all bridges shall maintain the existing bridge low chord, exceed the length and opening of the existing bridge, and span the main channel unless otherwise noted in the Project Design Criteria in Exhibit 4B.

Information provided in ATTACHMENT B is intended for use in the design of this project. The CONTRACTOR has the option to either utilize and update this provided information or to develop the CONTRACTOR’S own independent 1D model. If the contractor chooses to utilize the provided information then the CONTRACTOR shall verify that the data in the model is valid. All of the data that the contractor utilizes for the hydraulic analysis must be referenced in a signed and sealed Bridge Hydrology and Hydraulics Report. The CONTRACTOR shall verify that information provided in ATTACHMENT B being used to design this project meets the requirements for “SCDOT Requirements for Hydraulic Design Studies”, May 26, 2009, and all pertinent Design References located in Exhibit 4, Project Design Criteria. ~~The CONTRACTOR shall confirm the use of any previously prepared reports by providing a statement sealed by the CONTRACTOR’s engineer of record describing and certifying items being used.~~ If the RFP requirements are not met, then the CONTRACTOR shall provide all additional work necessary to meet the requirements for this specific project.

**b) HYDRAULIC MODELING**

The CONTRACTOR shall prepare ~~will utilize~~ a HEC-RAS 1-D study of the hydrologic/hydraulic characteristics of the natural, existing, and proposed conditions, ~~bridge supplied by the Department.~~ The CONTRACTOR ~~will shall~~ determine the beginning and end stations, finished grade elevations and optimal span configurations for the new bridges based on this study. The CONTRACTOR ~~will shall~~ also perform a two-dimensional model hydraulic analysis of the three bridges. The model shall include analysis of existing conditions which shall be calibrated using USGS gage data (or some other acceptable data) and shall include analysis of proposed conditions. In the study, the CONTRACTOR shall include model results for the appropriate storm events at the proposed bridge location. The CONTRACTOR ~~will shall~~ present a summary of their data collection, findings and proposed design procedure to the DEPARTMENT for review and comment prior to finalizing the design. Prior to setting the final roadway/bridge profile and submitting the preliminary Right-of-Way Plans, the CONTRACTOR shall provide model results and calculations that show the beginning and end stations, finished grade elevations and optimal span configurations for the new bridges. All hydraulic studies shall be approved by the DEPARTMENT.

In the vicinity (within 500’ upstream and downstream) of the proposed bridges, the required mapping shall include detailed stream cross-sections at minimum 100-foot intervals, and

outside of the 500' corridor, the required mapping shall at least include stream cross-sections at appropriate distances upstream and downstream based on bathymetry, lidar, or the USGS Topographic Maps. If the survey data provided in ATTACHMENT B is properly verified and calibrated by the CONTRACTOR, the CONTRACTOR has the option of using that data to perform the study. The CONTRACTOR shall perform any other work necessary to obtain the appropriate mapping.

The bridges are located within a FEMA Zone A designated flood hazard with no base flood elevation determined. New mapping from FEMA will not alter this requirement as described herein. The Department's policy for replacing bridges and culverts over FEMA Zone A designated flood hazard areas is to limit the backwater from the proposed bridge to 1.0 foot or less above the unrestricted or natural 100-year flood profile. According to the latest guidance from the USACE Charleston District's permit conditions, permitted activities shall not adversely impact the 100-year floodplain. Current USACE guidance suggests that, in order to obtain a permit, applicants must prove that there is no increase (0.0') in the existing 100-year flood profile or that no properties and/or structures outside of the applicant's own property boundaries are impacted. The CONTRACTOR shall ensure that the proposed design has no increase (0.0') to the existing 100-year flood profile. ~~water surface profile increase to no more than 1.0 foot above the existing 100-year flood profile.~~ If the proposed design does not revise the information previously forwarded to the local FEMA coordinators, no further FEMA coordination is required. If the proposed design merits revisions, the CONTRACTOR ~~will~~ shall prepare a similar letter to local county floodplain administrators. ~~stating that no increase greater than 1.0 foot has occurred. if requested by the local county floodplain administrator.~~

The bridge configuration must be set based on the triple profile which generally consists of cross sections cut 30' left and right of the proposed centerline and one at the proposed centerline. However the location of the offset cross sections shall be adjusted to best reflect stream alignment (i.e. more or less than 30 feet left and/or right) but excludes the existing roadway fill limits. No proposed fill can project into the channel. This means that even if the 2:1 slope intersects with natural ground prior to the channel the slope must be projected through the ground line to an elevation below the bottom of the channel. This projection must not cross through either the offset or the centerline plot of the channel (triple profile).

The edge of the proposed piles, shaft, columns, or piers should be 5' or more from the top of creek banks (channel overbanks). Section 1.2.1 Step 6 of the "SCDOT Requirements for Hydraulic Design Studies", May 26, 2009, addresses evaluation of potential for debris accumulation.

### c) DRAINAGE DESIGN

All closed storm drainage systems required for roadway drainage will be designed using the Geopak Drainage software. The design storm event and inlet spacing will be determined in accordance with the "SCDOT Requirements for Hydraulic Design Studies", May 26, 2009. The CONTRACTOR shall install a closed storm drainage system adjacent to the properties known as Horry County TMS#'s 182-00-01-048 and 182-00-01-050.

All open channel drainage systems will be designed in accordance with the “SCDOT Requirements for Hydraulic Design Studies”, May 26, 2009.

**d) NPDES STUDY AND SCDHEC NOI**

The CONTRACTOR will provide the stormwater management study and sediment and erosion control plans in the manner and form prescribed in the “SCDOT Requirements for Hydraulic Design Studies” dated May 26, 2009, as stated in section a) Hydrology and Hydraulic Design. The CONTRACTOR shall provide the Erosion Control Data Sheet. The CONTRACTOR should consider the use of temporary slope drains as needed.

If permanent water quality best management practices (BMPs) pertaining to the treatment of stormwater from this project are necessary and a Manufactured Treatment Device is selected as the BMP, reference the Supplemental Technical Specification for Stormwater Manufactured Treatment Devices (MTDs) to obtain the variables for the determination of the water quality storm discharge. Due to DHEC 401 permit regulations, bridge deck drainage cannot discharge directly into ~~the river~~ open waters before treatment.

The CONTRACTOR shall cross-check the water bodies for this project with SC DHEC’s most current 303(d) list and table for water bodies with approved TMDL’s to see if this receiving stream(s) has either an approved TMDL or a soon-to-be TMDL target date. If listed, the CONTRACTOR shall provide the necessary best management practices to bring the project in conformance with SC DHEC requirements. This process should also be updated prior to construction.

The CONTRACTOR shall comply with the intent of Presidential Executive Order on Invasive Species 13112, of February 3, 1999, by formulating a plan to actively re-plant native vegetation for all temporarily disturbed areas. The plan will include planting fast growing, locally native plant species to minimize the potential for establishment of aggressive, invasive species. The CONTRACTOR shall coordinate with the SCDOT’s Environmental Service’s Division and the Waccamaw National Wildlife Refuge to prepare and follow a plan that ensures compliance.

The CONTRACTOR will prepare and submit to the Department a permit package for the land disturbing activities associated with this project. The package will consist of a completed SC Department of Health and Environmental Control (SCDHEC) Notice of Intent (NOI) form (most recently approved) stating that the Department is the owner/operator along with all applicable documentation required as part of the permit, including a Stormwater Pollution Prevention Plan (SWPPP). The SWPPP preparer section of the NOI shall be signed in blue ink. If the Coastal Zone Consistency (CZC) permit has not been approved it shall be forwarded by the CONTRACTOR to the Department to submit to SCDHEC as part of the NOI package.

**e) SCOUR STUDY**

The CONTRACTOR shall perform the scour analysis for these bridges in accordance with FHWA’s HEC-18, HEC-20, the Department’s guidelines.. The CONTRACTOR will provide 100-year and 500-year scour profile information for the bridges using data developed by the

HEC-RAS and 2-d model. The 100-year and 500-year scour will be plotted to scale on the Triple Profile.

**f) FINAL DRAINAGE REPORT**

The CONTRACTOR will present a detailed study of the drainage to the Department. All final report, plans, drawings, calculation, etc. shall meet the approval of the Department prior to acceptance of the work. The ~~Consultant~~ CONTRACTOR shall ~~will~~ provide a design study report, signed and sealed by a professional engineer licensed in South Carolina, which includes the hydrologic and hydraulic design and scour analyses for the bridge, roadway surface drainage design, NPDES studies, TMDL information, Stormwater Management Study and sediment and erosion control recommendations and designs. The final report shall include results of modeling for the final proposed bridge configurations. All design calculations, field notes, drawing, reports and other material prepared under this agreement will be the property of the Department and will be turned over to the Department upon completion of the work.

**g) DELIVERABLES**

The CONTRACTOR shall provide the following to the Department with the Preliminary Plans:

- One (1) hard-copy and one (1) electronic copy of the Hydraulic Design Calculations and Models used in determining the minimum bridge openings

The CONTRACTOR shall provide the following to the Department with the Final Plans:

- Four (4) signed, completed copy (most recently approved) of the SCDHEC Notice of Intent (NOI),
- Four (4) completed CZC package, if applicable,
- Four (4) copies of the Bridge Hydrology and Hydraulic Report,
- Four (4) copies of the Final Drainage Report and Stormwater Management Report, and
- Four (4) complete “No-Impact” Certification (if applicable)
- Electronic copy of each submittal

# **EXHIBIT 4f**

## **GEOTECHNICAL DESIGN CRITERIA**

## 1. PROJECT SPECIFIC REQUIREMENTS

### SUBSURFACE INVESTIGATION

Section 4.3 of the GDM, last two sentences of the first paragraph of is amended as follows:

No more than half of the testing locations can be CPTu or DMT soundings. The use of “soil test boring” shall include the Standard Penetration Test (SPT) unless specifically indicated otherwise. In addition, 1 soil test boring shall be performed adjacent to a CPTu sounding to allow for correlation of the CPTu sounding to the actual soils encountered on site. Further, this soil test boring shall be continuously sampled for the upper 50 feet and sampled every 5 feet thereafter to the anticipated depth of CPTu sounding or to the actual termination depth of CPTu sounding, whichever is shallower.

The soil test boring shall be located no more than 5 feet from the location of the CPTu sounding and shall be at the same approximate elevation as the CPTu sounding. A professional engineer or professional geologist shall classify the soil samples obtained from the boring using both visual classification methods as well as index testing. Then the professional engineer or professional geologist shall compare the classifications from the soil test boring to the soil behavior type classifications indicated by the CPTu sounding. Differences between the soil classification of the samples from the boring and the soil behavior type from the CPTu data shall be reflected in subsequent use and presentation of the CPTu data (e.g., on subsurface cross sections).

Prior to being used on a SCDOT project, all electro-piezococones shall be calibrated to ascertain that the internal components of the cone are working correctly. Before performing each sounding and immediately after completion of the sounding, the zero readings of the cone shall be obtained. If the before “zero reading” is different from the after “zero reading”, the consultant shall determine if the cone is working properly. If the “zero readings” are different, the consultant shall determine if this will affect the results of the sounding. If the sounding is affected, then the consultant shall contact the RPG/GDS with this information along with recommendations as to what corrective action is required. If there is no change between the before “zero reading” and the after “zero reading”, then the “zero reading” shall be used to correct the results of the sounding.

**ROADWAY OPERATIONAL CLASSIFICATION**

In accordance with Bridge Design Memorandum DM0211, the Roadway Operation Classification (ROC) of the roadway embankments located within 150 feet of any of the US 701 Bridges over the Yauhannah Lake, Great Pee Dee River, and Great Pee Dee Overflow is “I”. All other roadway embankments located more than 150 feet from any of the bridges is “IV”.

Any existing embankment or portion of the existing embankment, incorporated into the new alignment shall be designed and valuated to meet the performance limits established in the GDM.

**SITE VARIABILITY**

In accordance with Section 7.5 of the GDM and using all deep (100 ft or greater) soil borings presented in the Geotechnical Base Line Report, S&ME, March 18, 2013 the Site Variability (SV) for the US 701 Bridges over the Yauhannah Lake, Great Pee Dee River, and Great Pee Dee Overflow is “Low”. However, SV is subject to change based on the results of the final geotechnical exploration conducted on the new alignment.

**SEISMIC DESIGN**

Three-Point Acceleration Design Response Spectrum (ADRS) curves have been supplied in this criterion, for the SEE and FEE design events. The ADRS curves are provided below and shall be used in the design of the embankments and bridge structure and are hereby incorporated into and made part of the contract documents.

A summary table of the applicable seismic coefficients is outlined below.

Latitude:	33.6622		Longitude:	79.1522	
Design EQ	PGA	S <sub>DS</sub>	S <sub>D1</sub>	M <sub>w</sub>	R(km)
FEE	0.11	0.23	0.13	7.35	64.3
SEE	0.35	0.75	0.43	7.36	62.2

Based on shear wave velocity measurements at the site, the final seismic Site Class has been determined to be “D”.



EXHIBIT 4f – GEOTECHNICAL DESIGN CRITERIA

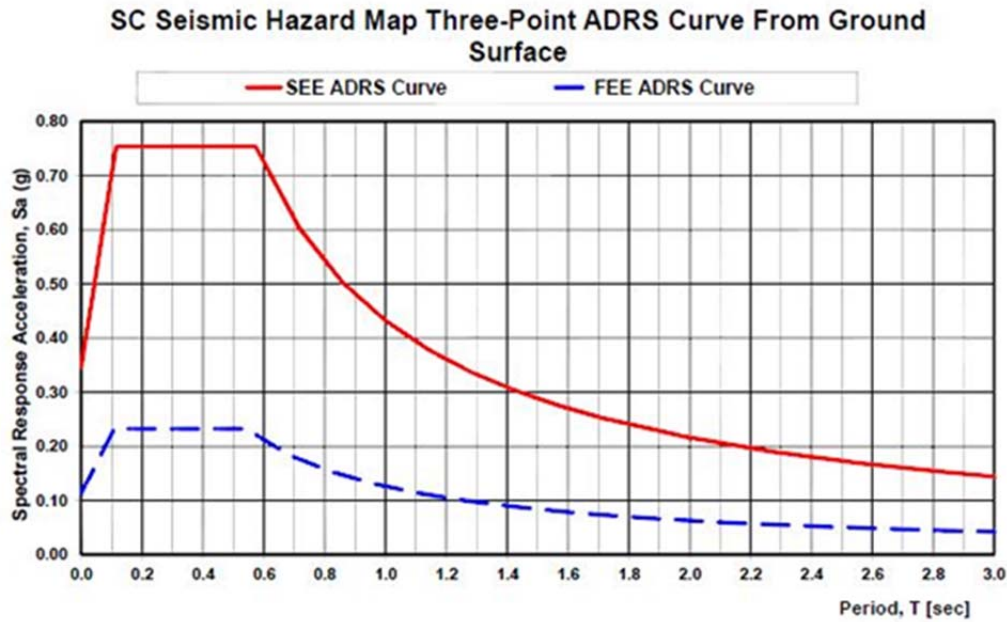

FEE ADRS Curve  
Three-Point Method

	T	S <sub>a</sub>
	0.00	0.11
	0.02	0.13
	0.04	0.15
	0.05	0.17
	0.07	0.19
	0.09	0.21
To	0.11	0.23
	0.14	0.23
	0.18	0.23
	0.22	0.23
	0.25	0.23
	0.29	0.23
	0.33	0.23
	0.36	0.23
	0.40	0.23
	0.43	0.23
	0.47	0.23
	0.51	0.23
Ts	0.54	0.23
	0.69	0.18
	0.83	0.15
	0.98	0.13
	1.12	0.11
	1.26	0.10
	1.41	0.09
	1.55	0.08
	1.70	0.07
	1.84	0.07
	1.99	0.06
	2.13	0.06
	2.28	0.06
	2.42	0.05
	2.57	0.05
	2.71	0.05
	2.86	0.04
	3.00	0.04

SEE ADRS Curve  
Three-Point Method

	T	S <sub>a</sub>
	0.00	0.35
	0.02	0.41
	0.04	0.48
	0.06	0.55
	0.08	0.62
	0.10	0.69
To	0.11	0.75
	0.15	0.75
	0.19	0.75
	0.23	0.75
	0.27	0.75
	0.31	0.75
	0.34	0.75
	0.38	0.75
	0.42	0.75
	0.46	0.75
	0.50	0.75
	0.54	0.75
Ts	0.57	0.75
	0.72	0.60
	0.86	0.50
	1.00	0.43
	1.14	0.38
	1.29	0.34
	1.43	0.30
	1.57	0.27
	1.72	0.25
	1.86	0.23
	2.00	0.22
	2.14	0.20
	2.29	0.19
	2.43	0.18
	2.57	0.17
	2.71	0.16
	2.86	0.15
	3.00	0.14

**SITE-SPECIFIC RESPONSE ANALYSIS**

If a SSRA is performed, a one dimensional non-linear site-specific response analysis is required. The analysis shall be developed in accordance with the following:

- The Geotechnical Engineer performing the SSRA shall have a minimum of 10 years' experience in geotechnical seismic design and shall have conducted a minimum of 7 site-specific response analyses as the lead designer. In addition, the Geotechnical Engineer shall be licensed as either an engineer (PE) or geologist (PG) pursuant to the laws of South Carolina
- Site-specific ADRS curves that are generated using non-linear effective stress site response software such as DMOD2000 or DeepSoil shall model the soils in both a liquefied and non-liquefied configuration and develop an ADRS envelope that combines the maximum spectral response amplifications for the site.
- A minimum of 7 time histories (synthetic or “real”) shall be required. The synthetic time histories shall be developed as indicated in Section 12.8.3 of the GDM. It is noted that prior to performing a site-specific response analysis a 3-Point ADRS is required. The 3-Point curves provided in this criterion shall be used for comparison purposes with the site-specific response analysis as required in Section 12.8.5 of the GDM.
- After the final RFP is issued, the Contractor can request the time histories using form GDF003 (Ground Motion Request) provided in Attachment B.
- Sections 12.8.2, 12.8.3 12.8.4, and 12.8.5 of the GDM are amended as follows:

**12.8.2. One-Dimensional Non-Linear Site-Specific Response**

Guidance in using non-linear site response analysis procedures can be obtained from Kwok et al. (2007). One-dimensional non-linear site response analyses shall be performed using approved computer software such as DMOD2000 (Mastasović and Ordóñez (2007)) that models the behavior of the soil subjected to cyclic loadings by tracing the evolution of the hysteresis loops generated in a soil by cyclic loading in a sequential manner. A number of other software programs such as DESRA-MUSC (Qiu, (1998)), and DeepSoil (Hashash (2012)) have been developed that modify and improve the accuracy of the constitutive soil models originally developed. Authorized software used to perform one-dimensional non-linear site-specific response analysis must be based on DMOD2000 (Mastasović and Ordóñez (2011)) or equivalent. Requests to use software other than those indicated above to perform the non-linear site-specific response analysis shall be made in writing to the PCS/GDS. Approval to use an alternate non-linear site-specific response analysis program shall be dependent on the software being nationally recognized in the United States and the designer is able to demonstrate project-specific experience using the proposed software.

### 12.8.3 Earthquake Ground Motion

SCDOT has chosen to generate synthetic project-specific time histories based on the Seismic Hazard Mapping study completed for SCDOT. The ground motion predictions used in the study are based on the results of work involving both empirical and theoretical modeling of CEUS strong ground motion. Even though the strong motion database for the East is small compared to the West, the available data indicate that high frequency ground motions attenuate more slowly in the East than in the West. The Seismic Hazard Mapping study computer program Scenario\_PC (2006) shall be used to generate synthetic ground motions.

A minimum of 7 time histories shall be required for a non-linear one-dimensional site-specific response analysis. As indicated previously, additional time histories may be needed based on the deaggregation results. Additional time histories may be required by SCDOT if project and site conditions warrant it. The time histories are generated based on project specific information using Scenario\_PC (2006). The CONTRACTOR shall submit a Ground Motion Request form (GDF 003) to the RPG/GDS to obtain project specific time histories. It is anticipated that the RPG/GDS will use GDF 003 for record keeping purposes. The Ground Motion Request form requires at a minimum that the GEOR provide the following information.

- SCDOT Project Name and Project Number
- Latitude and Longitude of Project Site
- Probability of Exceedance for Earthquake Design Event being analyzed
- Site Condition: Geologically Realistic or Hard-Rock Basement Outcrop
- Sediment Thickness: If other than default thickness generated from Scenario\_PC
- Scaling Method: Scaling of the time series to match Uniform Hazard, PGA, or PSA
- Moment magnitude ( $M_w$ ) and epicenter site-to-source distance (R)
- Seed number (1 to 1000)

### 12.8.4 Site Characterization

A one-dimensional soil column model is needed when performing a site-specific response analysis using non-linear methods. The soil column extends from either the bedrock or the geologically realistic site condition (B-C Boundary) to the location where the ground motion transmits the ground shaking energy to the structure being designed, typically the ground surface.

When performing non-linear one-dimensional site-specific response analysis, the soil layers in the one-dimensional column are characterized by the layer thickness, H; soil description including classification testing and geologic age; total unit weight ( $\gamma_T$ ); and, Shear Wave Velocity ( $V_s$ ). The development of the one-dimensional soil column for a project site may require making several assumptions as to the selection of layer thicknesses and soil properties.

The soil column model should be prepared in tabular form similar to Table 12-32. An equivalent-linear soil profile has a Shear Modulus Reduction and Equivalent Viscous

Damping Ratio Curves that are constant across each soil layer. In a non-linear soil profile, the Shear Modulus Reduction and Equivalent Viscous Damping Ratio Curves vary across the soil layer.

**Table 12-32, One-Dimensional Soil Column Model**

Geologic Time	Layer No.	Layer Thickness, $H_i$	Soil Formation	Soil Description (USCS)	PI	FC	Total Unit Weight, $\gamma_T$	Shear Wave Velocity, $V_{s,i}$
Quaternary	1							
	2							
Tertiary	3							
	4							
Cretaceous	5							
	6							
Bed Rock	i							

The CONTRACTOR shall perform a sensitivity analysis on the one-dimensional soil column model being developed to evaluate the consequences of the following:

- Variation in depth to B-C boundary and/or depth to basement rock
- Variations in soil properties for soils encountered below the maximum depth of the geotechnical investigation.
- Variations in soil properties of soils encountered during the geotechnical investigation across the project site.

The sensitivity analysis methodology must be well developed and documented in detail in the report. As a result of the sensitivity analysis performed, a series of site-specific horizontal acceleration response spectra (ARS) curves may be developed. A single recommended site-specific horizontal ARS curve should be superimposed on the graph to develop a site-specific ADRS curve. Since 7 ground motions will be used, the arithmetic mean of the ARSs may be used to develop the site-specific ADRS curve. The method of selecting the recommended site-specific ARS curve should be documented in the report. The sensitivity analysis will be required for each ground motion developed for the project site.

When performing a non-linear one-dimensional effective stress site-specific response analysis the soil column model input motions shall be documented to at least the same level of detail as used in the equivalent-linear one-dimensional site-specific response analysis.

In addition to the site-specific design response report, all electronic input and output files shall be submitted.

**12.8.5 Site-Specific Horizontal ADRS Curve**

The development of the recommended site-specific ADRS shall be based on results of the site-specific response analysis (Section 12.8.2). The Site-Specific ADRS curve shall be

developed for an equivalent viscous damping ratio of 5 percent. Additional ADRS curves may be required for other damping ratios appropriate to the indicated structural behavior (see Section 12.7.7). When the Site-Specific ADRS curve has spectral accelerations in the period range of greatest significance to the structural response are between the 3-Point ADRS curve and 70 percent of the 3-Point ADRS curve, the Site-Specific ADRS curve shall be used. If the Site-Specific ADRS curve is less than 70 percent of the spectral accelerations computed using the 3-Point method; an independent third-party review (Peer Review) of the ADRS curve by an individual with the expertise in the evaluation of ground motions is to be undertaken. The Peer Review shall be conducted by an individual who has a minimum of 10 years' experience in geotechnical seismic design and shall have conducted a minimum of 7 site-specific response analyses as the lead designer. In addition, the Peer Reviewer shall be licensed as either an engineer (PE) or geologist (PG) pursuant to the laws of South Carolina.

A smoothed ADRS curve shall be superimposed over the recommended site-specific acceleration response spectrum generated from site-specific response analysis (Sections 12.8.1 or 12.8.2). The steps to develop the smoothed ADRS curve shall be based on Table 12-33 and Figures 12-38 and 12-39.

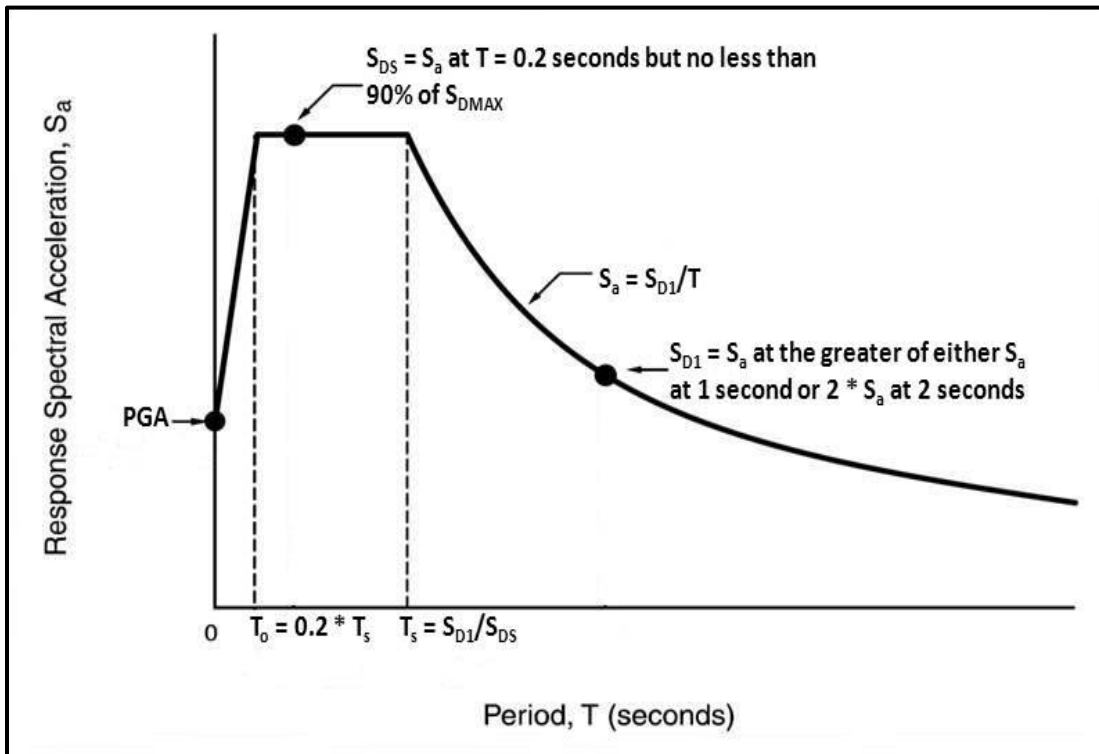

Figure 12.38, Site-Specific Horizontal ADRS Curve Construction

Table 12-33, Site-Specific ADRS Construction Procedures

EXHIBIT 4f – GEOTECHNICAL DESIGN CRITERIA

Step	Procedure Description
1	The design short-period acceleration, $S_{DS}$ , shall be the $S_a$ at $T = 0.20$ seconds but shall not be less than 90 percent of the maximum design spectral response acceleration, $S_{DMax}$ , at any period of greater than 0.20 seconds.
2	The design long-period acceleration, $S_{D1}$ , shall be the greater of either the $S_a$ at $T = 1.0$ seconds or twice the $S_a$ at $T = 2.0$ seconds.
3	<p>Period markers <math>T_o</math> and <math>T_s</math> used in constructing the Site-Specific ADRS curves are determined using the following equations.</p> $T_s = \frac{S_{D1}}{S_{DS}} \quad \text{Equation -1}$ $T_o = 0.20 * T_s \quad \text{Equation -2}$ <p>Where <math>S_{DS}</math> and <math>S_{D1}</math> are obtained in Steps 1 and 2.</p>
4	The PGA at the existing ground surface shall be determined, $T=0.0$ second.
5	<p>The design spectral response acceleration <math>S_a</math> for periods, <math>T \leq T_o</math>, is computed by the following equation.</p> $S_a = PGA + \left[ (S_{DS} - PGA) * \left( \frac{T}{T_o} \right) \right] \quad \text{Equation-3}$ <p>Where, <math>S_{DS}</math> is obtained in Step 1, <math>T_o</math> is obtained in Step 3, and PGA is obtained in Step 4.</p>
6	The design spectral response acceleration, $S_a$ , for periods, $T_o \leq T \leq T_s$ , is taken equal to $S_{DS}$ , as obtained in Step 1.
7	<p>The design spectral response acceleration, <math>S_a</math>, for periods, <math>T_s &lt; T \leq 3.0</math> seconds, is computed by the following equation.</p> $S_a = \frac{S_{D1}}{T} \quad \text{Equation-4}$ <p>Where, <math>S_{D1}</math> is obtained in Step 2.</p>
8	<p>The Site-Specific ADRS curve shall include the following items:</p> <ul style="list-style-type: none"> <li>• Site-Specific ADRS curve (both FEE and SEE as required)</li> <li>• Table of smoothed ADRS data values (<math>T</math> and <math>S_a</math>)</li> <li>• Provide the design spectral response parameters PGA, <math>S_{DS}</math>, <math>S_{D1}</math>; period markers <math>T_o</math> and <math>T_s</math>; <math>M_w</math> and <math>R</math>; PGV; <math>D_{a5-95}</math>; <math>V^*_{s,H}</math>; <math>H</math> and <math>T_N</math> and <math>T_P</math>. An example of the information required is shown in Figure 12-39.</li> </ul>

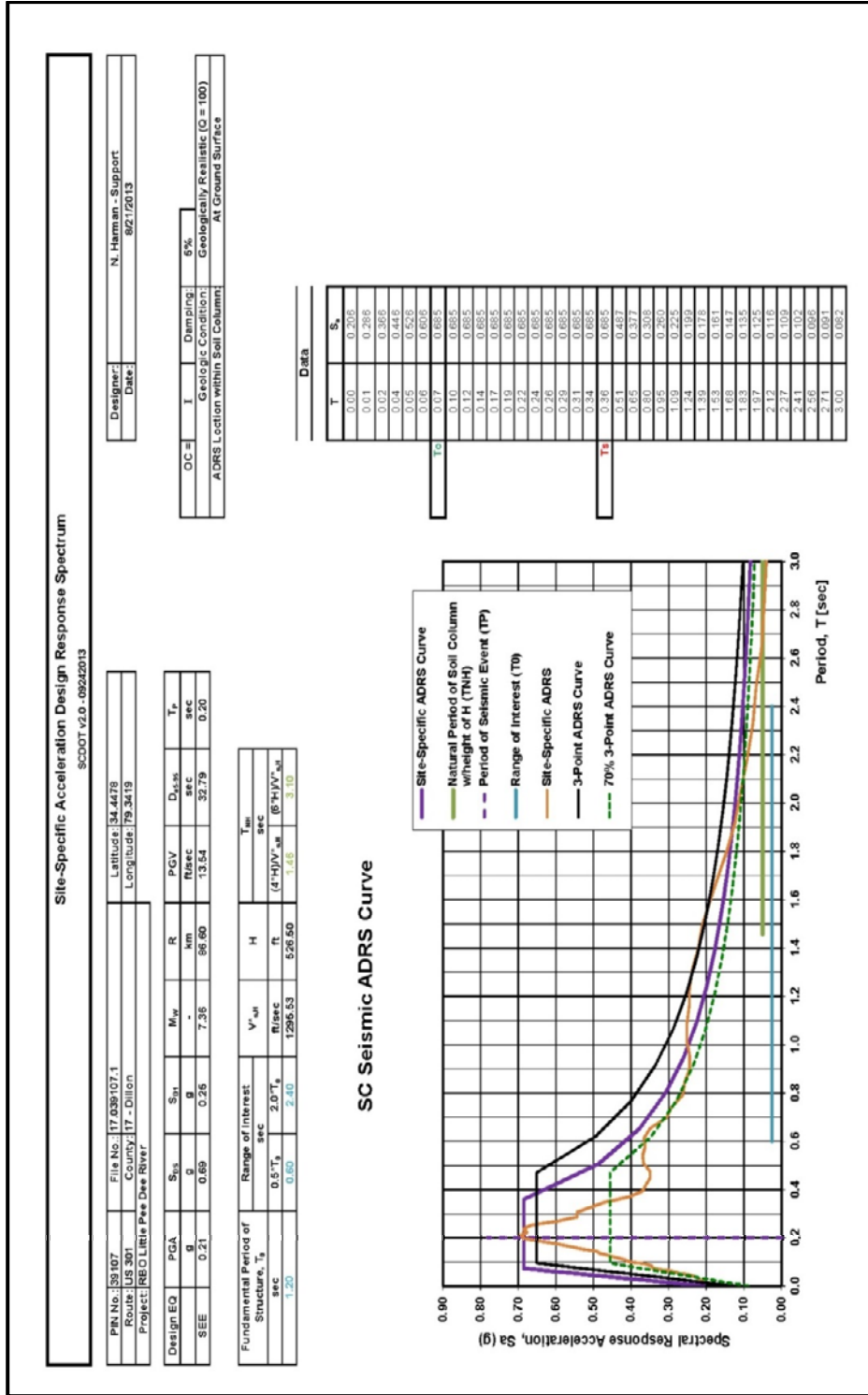

Figure 12-39, Site-Specific Horizontal ADRS Curve

**DYNAMIC LOAD TESTING WITH PILE DRIVING ANALYZER AND STATIC LOAD TESTING**

The CONTRACTOR shall be responsible for the testing of all foundations used on this project. For Pile Driving Analysis (PDA) testing the CONTRACTOR shall select a testing firm from those firms currently approved to provide foundation testing services on SCDOT’s Foundation Testing On-Call Contract. If driven piles are used, PDA testing in the form of a pile index program shall be performed. The CONTRACTOR shall provide a Pile Installation Plan (PIP) that shall include the pile index testing program. The pile index testing program shall at a minimum include the Bent and Pile number of each pile to be tested as well as the number of index piles to be tested. The number of index piles shall conform to the SCDOT Geotechnical Design Manual (GDM).

If drilled shafts are used, either a non-production drilled shaft shall be tested prior to the design and construction of any production drilled shafts or the CONTRACTOR may incorporate into his design the Report on Drilled Shaft Load Testing (Osterberg Method) Revision 01 (Report) dated June 6, 2013 provided in **ATTACHMENT B**. However, the number of load tests shall conform to the requirements of the latest version of the GDM. If the CONTRACTOR decides to use the results from the Report, the CONTRACTOR and its engineer of record shall verify this information by providing a ~~sealed~~ statement describing specific items and/or data being used. Any drilled shaft testing shall consist of either a static load test (bi-directional Osterberg Cell), a rapid load test (Statnamic), or a high-strain load test (Apple). The CONTRACTOR shall provide a Drilled Foundation Installation Plan (DFIP) that shall also include which load test procedure will be used (i.e. static, rapid, or high strain). The test shaft shall have a minimum diameter of 48 inches. The test shaft shall be located at least 25 feet from any existing bridge foundation and shall be positioned such that construction and testing operations do not adversely affect the existing bridge. In addition, the test shaft shall be located a minimum of 25 feet and a maximum of 50 feet from any future bridge drilled shaft foundation location. The location shall avoid conflicts with any construction staging, necessary work trestle, and/or utilities.

All testing reports whether for driven piles or drilled shafts shall bear the legible seal, signature, and date of the testing firm’s engineer that shall be registered as a Professional Engineer in the State of South Carolina. The CONTRACTOR’S designer shall review and approve, in writing, all load test reports prior to submitting the reports to SCDOT for review and acceptance or comment. Comments made by SCDOT shall be reviewed and rectified by the CONTRACTOR’S designer prior to the results of the load testing being used in design.



**GEOTECHNICAL DESIGN**

The following reports have been provided in Attachment B for geotechnical information.

1. Report of Conceptual Phase Geotechnical Exploration, S&ME, May 17, 2005
2. Geotechnical Base Line Report, S&ME, March 18, 2013
3. Report on Drilled Shaft Load Testing (Osterberg Method), Loadtest USA, June 6, 2013

In addition to the aforementioned geotechnical reports, SCDOT's proposed plans for Georgetown and Horry counties, (File No. 2226.036683) Shaft Load Test for Replacement of US-701 Bridges over Lake Yauhannah, Great Pee Dee River, and Pee Dee Overflow has been provided in Attachment B. It shall be noted that all information contained in S&ME's conceptual report precedes the GDM and this report has been provided for information purposes only. SPT borings and CPT soundings provided in S&ME's conceptual report shall not be incorporated into design. The stations, offsets, and elevations of the soil borings presented in S&ME's base line report are outlined in the Summary of Test Locations in page 5 of the Geotechnical Base Line Report.

All geotechnical design and testing shall comply with the requirements of the SCDOT GDM and the Special Provisions listed in Exhibit 5. Geotechnical information provided as part of this RFP is intended for use in the design of this project. The CONTRACTOR shall verify that geotechnical information provided in **ATTACHMENT B** meets the requirements for a geotechnical investigation for this specific project as contained in the GDM. The CONTRACTOR shall confirm the use of any previously prepared reports by providing a statement ~~from sealed by~~ the CONTRACTOR's engineer of record describing ~~and certifying~~ any and all items being used. If the requirements of the GDM are not met, then the CONTRACTOR shall provide additional geotechnical investigation to meet the geotechnical requirements for this specific project.

Based on SCDOT'S preliminary review of the existing geotechnical information, based on the most current GDM requirements, and contrary to the information provided in the Report of Conceptual Phase Geotechnical Exploration, it appears that ground modification will be required; however it is the responsibility of the CONTRACTOR to perform a detailed liquefaction and stability analysis to verify the need for ground modification and to ensure all performance limit requirements are met as stated in the GDM. All geotechnical design for ground modifications shall comply with the requirements of the GDM. Any ground modification used on this project shall comply with the requirements set forth in **EXHIBIT 5** Special Provisions. If column supported embankments are used as a ground modification, the design method shall be the Collin Method as outlined in the GDM. Listed below are ground modifications acceptable for use on this project.

- Prefabricated Earthquake Drains with Filter Fabric
- Prefabricated Vertical Drains
- Ground Modification – Vibro-Stone Columns
- Ground Modification – Vibro-densification
- Deep Soil Mixing
- Compaction Grouting
- High-Strength Geotextile for Embankment Reinforcement
- Geotextile for Separation and Stabilization
- Geogrid Soil Reinforcement
- Lightweight Aggregate
- Muck Excavation
- Bridge Lift Materials
- Reinforced Soil Slopes
- Column-Supported Embankments

### **SPECIAL PROVISIONS**

For Special Provisions included in Division 200: Settlement Plates, Ground Modification - Compaction Grouting Columns, Deep Soil Mixing, Geogrid Soil Reinforcement, Ground Modification – Vibro Stone Column, Light Weight Aggregates, High-Strength Geotextile for Embankment Reinforcement, Prefabricated Earthquake Drain with Filter Fabric, Prefabricated Vertical Drain With Fabric, Monitoring Devices – Piezometer, Settlement Sensors, Total Pressure Cells, Vibrating Wire Data Collection Center, Vibrating Wire Rod Extensometer, Vibro Compaction, and Division 700: Axial O-Cell Load Testing of Drilled Shafts and Monitoring of Construction Related Earthborne Vibrations, and Section 203 Muck Excavation, the “Engineer” applies to the Engineer of Record.

# **EXHIBIT 5**

## **SPECIAL PROVISIONS**

**SPECIAL PROVISIONS  
FOR  
Replacement of US 701 Bridges over the Great Pee Dee River and  
Yauhannah Lake  
Horry / Georgetown Counties**

**TABLE OF CONTENTS**

(1)	DIVISION 100: ERRATA TO 2007 STANDARD SPECIFICATIONS FOR HIGHWAY CONSTRUCTION: .....	4
(2)	SECTION 101: STANDARD DRAWINGS: .....	4
(3)	SECTION 102: STANDARD DRAWING ERRATA: .....	4
(4)	SECTION 105: CONSTRUCTION STAKES, LINES AND GRADES:.....	6
(5)	SECTION 105: CLAIMS PROCEDURE:.....	6
(6)	SECTION 106: QUALIFIED PRODUCT LISTINGS: .....	6
(7)	SECTION 106: PLANT/FABRICATOR INSPECTION: .....	6
(8)	SECTION 106: SOUTH CAROLINA MINING ACT: .....	7
(9)	SECTION 107: PROJECT BULLITEN BOARDS: .....	7
(10)	SECTION 107: FAIR LABOR STANDARDS ACT OF 1938, AS AMENDED: .....	7
(11)	SECTION 107: APPLICATION OF DAVIS-BACON AND RELATED ACTS TO INDEPENDENT TRUCK DRIVERS AND MISCELLANEOUS CONSTRUCTION ACTIVITIES: .....	7
(12)	SECTION 107: DISADVANTAGED BUSINESS ENTERPRISES (DBE) GOALS AND REQUIREMENTS: .....	7
(13)	SECTION 107: DISADVANTAGED BUSINESS ENTERPRISES (DBE) GOALS AND REQUIREMENTS: .....	8
(14)	SECTION 107: LATE DISCOVERY OF ARCHAEOLOGICAL/HISTORICAL REMAINS ON FEDERAL AID PROJECTS AND APPROVAL OF DESIGNATED BORROW PITS: .....	11
(15)	SECTION 107: REQUIREMENTS FOR FEDERAL AID CONTRACTS WHICH AFFECT SUBCONTRACTORS, DBE HAULERS, MATERIAL SUPPLIERS AND VENDORS: .....	11
(16)	SECTION 107: SPECIFIC EQUAL EMPLOYMENT OPPORTUNITY RESPONSIBILITY TRAINING SPECIAL PROVISIONS:.....	11
(17)	SECTION 107: DBE PARTICIPATION: .....	11
(18)	SECTION 107: CONTRACT PROVISION TO REQUIRE CERTIFICATION AND COMPLIANCE CONCERNING ILLEGAL ALIENS .....	11
(19)	SECTION 107: CRANE SAFETY:.....	12
(20)	SECTION 107: REQUIRED MEDIA NOTIFICATION FOR CONSTRUCTION PROJECTS:.....	12
(21)	SECTION 107: PERMITS: .....	12
(22)	SECTION 107: COORDINATION OF UTILITY RELOCATION WORK WITH HIGHWAY CONSTRUCTION: .....	12
(23)	SECTION 108: PARTNERING:.....	13
(24)	SECTION 108: CRITICAL PATH METHOD CONSTRUCTION SCHEDULES:.....	13
(25)	SECTION 108: FAILURE TO COMPLETE THE WORK ON TIME .....	13
(26)	SECTION 109: PAYMENT SCHEDULE .....	13
(27)	SECTION 109: REFERENCES TO UNIT PRICING: .....	14
(28)	SECTION 109: RETAINAGE .....	15
(29)	SECTION 109: PROMPT PAYMENT CLAUSE: .....	15
(30)	SECTION 109: FUEL ADJUSTMENT: .....	15
(31)	SECTION 202: RECLAIMING EXISTING ROADWAY:.....	15
(32)	SECTION 202: STAGED REMOVAL OF EXISTING BRIDGES: .....	16
(33)	SECTION 202: REMOVAL AND DISPOSAL OF STRUCTURES CONTAINING STRUCTURAL COMPONENTS WITH LEAD-BASED PAINT:.....	16
(34)	SECTION 202: REMOVAL OF EXISTING GUARDRAIL: .....	16
(35)	SECTION 202: REMOVAL OF STRUCTURES AND OBSTRUCTIONS: .....	16
(36)	SECTION 203: BORROW PITS ON LARGE PROJECTS: .....	16
(37)	SECTION 204: TEMPORARY SHORING WALL: .....	16

**EXHIBIT 5 – SPECIAL PROVISIONS**

(38)	SECTION 208: FINE GRADING: .....	17
(39)	SECTION 305: MAINTENANCE STONE: .....	17
(40)	SECTION 401: PRICE ADJUSTMENT FOR LIQUID ASPHALT BINDER: .....	17
(41)	SECTION 401: HOT MIX ASPHALT (HMA) QUALITY ASSURANCE: .....	17
(42)	SECTION 401: HOT-MIX ASPHALT RIDEABILITY: .....	17
(43)	SECTION 401: TRANSPORTATION AND DELIVERY OF MIXES:.....	18
(44)	DIVISION 600: MANUAL ON UNIFORM TRAFFIC CONTROL DEVICES: .....	18
(45)	DIVISION 600: RULE ON WORK ZONE SAFETY AND MOBILITY:.....	18
(46)	DIVISION 600, ETAL.: ADHESIVELY BONDED ANCHORS AND DOWELS:.....	18
(47)	DIVISION 600: EVALUATION OF RETROREFLECTIVITY:.....	18
(48)	DIVISION 600: WORK ZONE TRAFFIC CONTROL TRAINING REQUIREMENTS FOR CONTRACTORS / SUBCONTRACTORS: .....	19
(49)	SECTION 601: PENALTY FOR VIOLATING LANE CLOSURE RESTRICTIONS:.....	19
(50)	SECTION 609: HIGH PRESSURE WATER METHOD FOR REMOVAL OF PAVEMENT MARKINGS:.....	19
(51)	DIVISION 700: DYNAMIC LOAD TESTING WITH PILE DRIVING ANALYZER AND STATIC LOAD TESTING:.....	19
(52)	SECTION 701: CONCRETE BATCHING AND MIXING:.....	20
(53)	SECTION 701: NON-CONFORMING CONCRETE:.....	20
(54)	SECTION 711: PILE AND DRIVING EQUIPMENT DATA FORM: .....	20
(55)	SECTION 712: DRILLED SHAFTS:.....	20
(56)	SECTION 714: PIPE END TREATMENTS (2/5/2010).....	20
(57)	SECTION 714: SMOOTH WALL PIPE: .....	23
(58)	SECTION 720: DETECTABLE WARNING SURFACE:.....	25
(59)	SECTION 727: CROSSHOLE SONIC LOGGING OF DRILLED SHAFT FOUNDATIONS: .....	26
(60)	SECTION 805: GUARDRAIL END TERMINAL - TYPE T: .....	26
(61)	SECTION 805: HEIGHT OF W-BEAM GUARDRAIL: .....	26
(62)	SECTION 802: GEOCOMPOSITE WALL DRAIN DATED MAY 6, 2003: .....	27
(63)	SECTION 801: GEOTEXTILE FOR DRAINAGE FILTRATION: .....	29
(64)	SECTION 814: COLD APPLIED WATERPROOFING DATED MAY 29, 2003:.....	30
(65)	SECTION 809: RIGHT OF WAY PLAT: .....	31
(66)	SECTION 810: SEEDING: .....	32
(67)	SECTION 815: EROSION CONTROL MEASURES: .....	32
(68)	SAFETY FENCE:.....	36
(69)	DIVISION 200: SETTLEMENT PLATES:.....	36
(70)	NONWOVEN GEOTEXTILE INTERLAYER FABRIC FOR CONCRETE PAVEMENT: .....	41
(71)	DIVISION 200: GROUND MODIFICATION – COMPACTION GROUTING COLUMNS.....	43
(72)	DIVISION 200: GEOTEXTILES FOR SEPARATION AND STABILIZATION .....	51
(73)	DIVISION 200: BRIDGE LIFT MATERIALS .....	55
(74)	DIVISION 200: DEEP SOIL MIXING .....	56
(75)	DIVISION 200: GEOGRID SOIL REINFORCEMENT.....	78
(76)	DIVISION 200: GROUND MODIFICATION – VIRBRO STONE COLUMN .....	82
(77)	DIVISION 200: LIGHTWEIGHT AGGREGATES .....	86
(78)	DIVISION 200: HIGH-STRENGTH GEOTEXTILE FOR EMBANKMENT REINFORCEMENT .....	87
(79)	SECTION 203: MUCK EXCAVATION .....	94
(80)	DIVISION 200: PREFABRICATED EARTHQUAKE DRAIN WITH FILTER FABRIC .....	96
(81)	DIVISION 200: PREFABRICATED VERTICAL DRAIN WITH FABRIC .....	103
(82)	DIVISION 200: REINFORCED SOIL SLOPES (RSS).....	109
(83)	DIVISION 200: MONITORING DEVICES - PIEZOMETER .....	113
(84)	DIVISION 200: SETTLEMENT SENSORS .....	114
(85)	DIVISION 200: TOTAL PRESSURE CELLS.....	119
(86)	DIVISION 200: VIBRATING WIRE DATA COLLECTION CENTERS .....	121
(87)	DIVISION 200: VIBRATING WIRE ROD EXTENSOMETER.....	123
(88)	DIVISION 700: AXIAL O-CELL LOAD TESTING OF DRILLED SHAFTS .....	126
(89)	DIVISION 700: APPLE LOAD TESTING.....	130
(90)	DIVISION 700: STATNOMIC LOAD TESTING.....	134
(91)	<del>PAVING UNDER GUARDRAIL.....</del>	138

**EXHIBIT 5 – SPECIAL PROVISIONS**

(92) DIVISION 600: ADHESIVELY BONDED ANCHORS AND DOWELS ..... 142

(93) DIVISION 702: CONCRETE STRUCTURES – PREFORMED JOINT FILLER..... 142

(94) DIVISION 200: VIBRO COMPACTION..... 142

(95) SECTION 203: BORROW EXCAVATION..... 146

(96) DIVISION 700: MONITORING OF CONSTRUCTION-RELATED EARTHBORNE  
VIBRATIONS ..... 146

(97) SECTION 729: NAVIGATION LIGHTS FOR BRIDGE..... 150

EXHIBIT 5 – SPECIAL PROVISIONS

**(1) DIVISION 100: ERRATA TO 2007 STANDARD SPECIFICATIONS FOR HIGHWAY CONSTRUCTION:**

The Supplemental Specification entitled "Errata to 2007 Standard Specifications for Highway Construction" dated **May 4, 2009** in **Exhibit 6** is hereby amended to include the following:

Division 100 is amended as follows:

Page 4, The table in **Subsection 101.2** is amended as follows:

**SCDOT OFFICIALS AND OFFICES**

DELETIONS		REPLACEMENTS	
<del>SHE*</del>	<del>State Highway Engineer</del>	DSE*	Deputy Secretary for Engineering

\*Wherever it appears in the text, replace the deleted abbreviation with the new abbreviation.

**(2) SECTION 101: STANDARD DRAWINGS:**

The Bidders are hereby advised that this project shall be constructed using the 2011 Standard Drawings with all updates effective at the time of the letting. The Standard Drawings are available for download at [http://www.scdot.org/doing/sd\\_disclaimer.shtml](http://www.scdot.org/doing/sd_disclaimer.shtml). All drawings that are updated are labeled with their effective letting date in red.

The Standard Drawings are available to purchase through the SCDOT Engineering Publications Sales Center. The Engineering Publication Sales Center is located in Room G-19 (basement level) of the SCDOT Headquarters Building, 955 Park Street, Columbia, South Carolina.

All references in the plans, standard specifications, supplemental specifications, supplemental technical specifications or special provisions to drawings under the previous numbering system are hereby updated to the new drawing numbers. Refer to sheets 000-205-01 through 000-205-07 to find new drawing numbers when looking for references to older drawing numbers.

**(3) SECTION 102: STANDARD DRAWING ERRATA:**

The Bidders are hereby advised that the following note changes apply to the published Standard Drawings.

On sheet **000-205-05**, add the following information under the columns below:

OLD DRAWING NAME	NEW DRAWING NAME
720-905-01 to 720-905-05	720-901-01 to 720-993-32

On sheet **605-005-05**, replace entire text of General Note #4 with the following text:

4. The square footage of sign panels attached to 2½" x 2½" 12 gauge sign support secured to a 3" x 3" 7 gauge breakaway anchor shall not exceed 20 square feet.

On sheet **610-005-00**, revise the following information as noted below:

Add **(OPTIONAL)** underneath "TRUCK MOUNTED ATTENUATOR" adjacent to the illustration.

A chart, entitled "Truck Mounted Attenuator", displaying the minimum length of buffer space required when a truck mounted attenuator is not utilized.

## EXHIBIT 5 – SPECIAL PROVISIONS

The buffer area illustration has been update to illustrate the requirements necessary when a truck mounted attenuator is utilized and the requirements necessary when a truck mounted attenuator is not utilized.

Underneath the section entitled “PORTABLE TRUCK MOUNTED ATTENUATOR”, update Note 4 to read as follows:

A trailer mounted advance warning arrow panel may be utilized in advance of the work area when this traffic control setup is utilized for asphalt concrete placement operations.

On sheet 610-405-00, revise the following information as noted below:  
Add **(OPTIONAL)** underneath “LEAD VEHICLE” adjacent to the illustration.

The “WORK VEHICLE” signing requirements have been updated. When the “LEAD VEHICLE” is omitted, the first “WORK VEHICLE” in the work train will also include the signing requirements specified for the “LEAD VEHICLE” in addition to the standard signing requirements for the “WORK VEHICLE”.

Note 2 of the “Operation Notes” has been updated to describe the requirements for the “WORK VEHICLE” when the “LEAD VEHICLE” is omitted from the work train.

On sheet 720-305-00, delete the entire note directly above main detail:  
~~If sidewalk exists, the driveway opening should...~~

On sheet 720-405-00 section B replace dimension 2’-6” maximum with:  
2’-6” minimum

On sheet 720-901-01 replace note 5.04 with:  
5.04 When a mid-block crossing is required, consider mid-block staggered crossing (720-955-41) to encourage eye contact between the pedestrian and the oncoming traffic. Always angle the stagger so that the pedestrian travels through the refuge facing the oncoming traffic.

On sheet 722-305-00 Detail 4 replace note “French Drain see note 21” with:  
French Drain see note 4.5.

On sheet 722-305-00 table 722-305A, 4<sup>th</sup> column, change the following:  
Delete (SF)

Replace text “up to 36” with “up to 3’X3’ “

Replace text “larger than 36” with “larger than 3’X3’ ”

On sheet 804-105-00 Title Block replace text “Rirap (Bridge End)” with:  
Riprap (Bridge End)

On sheet 805-325-00 detail 2 replace text “rectangular washers (FWR03) See 805-005-00” with:  
“rectangular washers (FWR03) See 805-090-00”

On sheet 805-325-00 change text of note 5 to the following:  
5. For project specific requirements such as additional offset blocks, extra length posts, and post attachment details, see Project Plans. Include all costs of project specific requirements in the Guardrail Thrie-Beam Bridge Connector pay item.



**EXHIBIT 5 – SPECIAL PROVISIONS**

On sheet **805-330-00** detail 2 replace text “rectangular washers (FWR03) See 805-005-00” with:  
“rectangular washers (FWR03) See 805-090-00”

On sheet **805-330-00** change text of note 4 to the following:

4. For project specific requirements such as additional offset blocks, extra length posts, and post attachment details, see Project Plans. Include all costs of project specific requirements in the Guardrail Thrie-Beam Bridge Connector pay item.

On sheet **805-510-00** detail 3 replace guardrail base plate note with the following:  
See standard drawings 805-655-xx for guardrail base plate options.

On sheet **805-655-M1** replace note 30.4 with the following:

30.4 Install adhesive anchors to a depth sufficient to develop a minimum factored (reduced) ultimate tensile capacity of 21 kips per anchor bolt. Increase minimum embedment shown in detail 4 as required by adhesive manufacturer’s recommendations for the existing material properties, anchor bolt pattern, edge conditions, and any other design reduction.

On sheet **805-811-01** Type 11A barrier wall reinforcement add the following note:

Provide reinforcement equal to the stem reinforcement and bending details shown for the Type 11B concrete barrier (drawing 805-811-02).

**(4) SECTION 105: CONSTRUCTION STAKES, LINES AND GRADES:**

Section 105.8.2 applies to this project. Payment for this work shall be made according to the following schedule:

<b>Percent Contract Complete</b>	<b>Percent of Stakes, Lines, and Grades bid amount to be paid</b>
1 – 5	20
6 – 15	40
16 – 29	60
30 – 49	70
50 – 69	80
70 – 89	90
90 - 100	100

**(5) SECTION 105: CLAIMS PROCEDURE:**

See Supplemental Specification entitled “Claims Procedure” dated **June 2, 2014**, in **Exhibit 6**. For this project, the STANDING DISPUTE REVIEW BOARD is designated.

**(6) SECTION 106: QUALIFIED PRODUCT LISTINGS:**

All references to “Approval Sheet” or “Approval Policy” are to be replaced with “Qualified Products Listings (QPL)” and “Qualified Products Policies (QPP)” respectively. This change includes all references in the SCDOT Standard Drawings, SCDOT Standard Specifications, SCDOT Supplemental Specifications, SCDOT Special Provisions, SCDOT Supplemental Technical Specifications, SCDOT Internet and Intranet websites, and all other documents produced by SCDOT.

**(7) SECTION 106: PLANT/FABRICATOR INSPECTION:**

**EXHIBIT 5 – SPECIAL PROVISIONS**

Subsection 106.4, **Plant Inspection**, of the Standard Specifications shall be amended with the following:

Change the subsection title to **Plant/Fabricator Inspection** and add the following sentence after the first sentence:

“Provide 14 calendar days written notice to the Materials and Research Engineer prior to beginning fabrication work for Department projects.”

**(8) SECTION 106: SOUTH CAROLINA MINING ACT:**

See Attached Supplemental Specification Dated **March 20, 2003**.

This Supplemental Specification is hereby modified as follows:

Paragraph 9 is hereby deleted and replaced with the following:

The Deputy Secretary for Engineering, or his duly appointed representative, will make a final inspection of the reclaimed area and keep a permanent record of his approval thereof. A map or sketch providing the location and approximate acreage of each pit used on the project will be provided to the Resident Construction Engineer for inclusion in the final plans.

The last paragraph is hereby deleted and replaced with the following:

The contractor shall comply with the provisions of the plan that are applicable to the project as determined by the engineer. Seeding or other work necessary to comply with the plan on pits furnished by the contractor shall be at the expense of the contractor. Seeding shall be in accordance with SC-M-810 (latest version) which can be found at [http://www.scdot.org/doing/road\\_SupTechSpec.aspx](http://www.scdot.org/doing/road_SupTechSpec.aspx).

**(9) SECTION 107: PROJECT BULLITEN BOARDS:**

In accordance with the Required Contract Provisions Federal-Aid Construction Contracts Section II, Item 3, Part d, add the following:

For this project, a bulletin board shall be placed at the project location. Mount the project bulletin board in a permanent location within the project limits so that it is visible and accessible at all times. Notify the RCE and all subcontractors as to the location of the bulletin board.

**(10) SECTION 107: FAIR LABOR STANDARDS ACT OF 1938, AS AMENDED:**

Attention is directed to this Federal Legislation, which has been enacted into law. The contractor will be responsible for carrying out all of the provisions of this legislation, which may affect this contract.

**(11) SECTION 107: APPLICATION OF DAVIS-BACON AND RELATED ACTS TO INDEPENDENT TRUCK DRIVERS AND MISCELLANEOUS CONSTRUCTION ACTIVITIES:**

See attached Supplemental Specification dated **June 13, 1990** in **Exhibit 7**.

**(12) SECTION 107: DISADVANTAGED BUSINESS ENTERPRISES (DBE) GOALS AND REQUIREMENTS:**

The DBE goal for the project is as follows:

**DISADVANTAGE BUSINESS ENTERPRISES CONTRACT GOAL** **8 %**

## EXHIBIT 5 – SPECIAL PROVISIONS

See attached Supplemental Specification entitled special provision "Disadvantaged Business Enterprises (DBE)" dated **May 2, 2014** for specific requirements that must be met.

The contractor's attention is invited to the electronic DBE BIN file found on the electronic bidding service website, *Bid Express*, containing data from the "Directory of Certified Disadvantaged Business Enterprises" approved for use in each particular letting. It specifies the amount (percentage) that the contractor may count toward its appropriate DBE Goals of expenditure for materials and supplies obtained from DBE Suppliers and Manufacturers.

### **(13) SECTION 107: DISADVANTAGED BUSINESS ENTERPRISES (DBE) GOALS AND REQUIREMENTS:**

#### **1. GENERAL**

For Design Build Projects, PROPOSER shall comply with the Disadvantaged Business Enterprises (DBE) Supplemental Specification, dated May 2, 2014, except as specifically modified pursuant to this special provision. This special provision modifies the timing and steps for which the PROPOSER is to obtain DBE committals for a design build project.

#### **2. DBE PROGRAM RELATED CERTIFICATIONS**

By submitting a proposal and by entering into any contract on the basis of that proposal, the PROPOSER certifies to each of the following DBE Program-related conditions and assurances:

- a. That the PROPOSER agrees to comply with the project construction and administration obligations of the USDOT DBE Program, 49 CFR Part 26 as amended, and the DBE Supplemental Specifications setting forth the SCDOT's DBE Program requirements.
- b. PROPOSER shall comply fully with the DBE Program requirements in the execution and performance of the Contract. PROPOSER acknowledges that failure to comply may result in any one or more of the sanctions listed in the SCDOT's DBE Supplemental Specification.
- c. To ensure that DBE firms have been given full and fair opportunity to participate in the performance of the contract, PROPOSER certifies that all reasonable steps were, and will be, taken to ensure that DBE firms had, and will have, an opportunity to compete for and perform work on the contract. The PROPOSER further certifies that the PROPOSER shall not discriminate on the basis of race, color, age, national origin, or sex in the performance of the contract or in the award of any subcontract. Any agreement between a PROPOSER and a DBE whereby the DBE promises not to provide quotations for performance of work to other PROPOSERS is prohibited.
- d. PROPOSER shall make good faith efforts to obtain DBE participation in the proposed contract at or above the goal. The PROPOSER, by submitting its proposal, certifies the DBE participation information that will be submitted within the required time as specified herein is true, correct, and complete, and that the information to be provided includes the names of all DBE firms that will participate in the contract, the specific item(s) that each listed DBE firm will perform, and the dollar amounts of the participation of each listed DBE.
- e. By submitting its proposal, the PROPOSER certifies that good faith efforts will be made on work that it proposes to subcontract; and that it will seek out and consider

## EXHIBIT 5 – SPECIAL PROVISIONS

DBE firms as potential subcontractors and sub-consultants. The PROPOSER shall, as a continuing obligation, contact DBE firms to solicit their interest, capability, and prices in sufficient time to allow them to respond effectively, and shall retain on file proper documentation to substantiate its good faith efforts.

- f. PROPOSER shall comply fully with all contractual and legal requirements of the USDOT DBE Program and SCDOT DBE Program, and shall cause each DBE firm participating in the Contract to fully perform the designated work items with the DBE firm's own forces and equipment under the DBE firm's direct supervision, control, and management. Where a contract exists and where the PROPOSER, DBE firm, or any other firm retained by the PROPOSER has failed to comply with federal or SCDOT DBE Program requirements, SCDOT has the authority and discretion to determine the extent to which the DBE contract regulations have not been met, and will assess against the PROPOSER any remedies available at law or provided in the contract.
- g. If a bond surety assumes the completion of work, if for any reason the SCDOT has terminated the PROPOSER, the surety shall be obligated to meet the same DBE contract terms and requirements as were required of the original PROPOSER in accordance with the requirements of this contract.

### 3. DBE PROGRAM COMPLIANCE PROCEDURES

#### a. DBE Utilization Plan

- (1) Within thirty (30) calendar days from the effective date of the Agreement, the PROPOSER shall submit to the SCDOT a DBE Utilization Plan for review and approval. This plan shall include the following information:
  - i. The various work elements the PROPOSER anticipates subcontracting to DBE firms in order to meet the established contract goal;
  - ii. The expected dollar amount and contract percentages of each work element to be applied towards meeting the contract goal; and
  - iii. Anticipated timeframes for which PROPOSER expects DBE subcontracts to be executed for each of the work elements identified.
- (2) As the Project proceeds through the design phase, the PROPOSER may submit revisions to the approved DBE Utilization Plan, if necessary, for the SCDOT's consideration and approval. Reasons for the revisions shall be documented by the PROPOSER and included in the revision request.
- (3) In the DBE Utilization Plan submittal, CONTRACTOR shall designate and make known to the SCDOT a DBE liaison officer who is assigned the responsibility of administering and promoting an active and inclusive DBE program as required by 49 CFR Part 26, the SCDOT's DBE Supplemental Specifications, and this Special Provision.
- (4) After approval of the DBE Utilization Plan, PROPOSER may begin submitting DBE Committal Sheets for review and acceptance at the monthly Progress Meetings.

#### b. Establishing DBE Committals

## EXHIBIT 5 – SPECIAL PROVISIONS

- (1) The PROPOSER shall aggressively implement the approved DBE Utilization Plan by submitting DBE Committal Sheets listing specific DBE firms to carry out the identified work elements. **The use of DBE firms and the information to be provided on the DBE Committal Sheet shall be as instructed in Part A of the SCDOT's DBE Supplemental Specification (Exhibit 7).**
- (2) The PROPOSER shall obtain the SCDOT's approval of all subcontracts as set forth in the SCDOT DBE Supplemental Specification.
- (3) PROPOSER shall not unilaterally terminate, substitute for, or replace any DBE firm listed on the Committal Sheet in whole or in part with another DBE, any non-DBE firm, or with the PROPOSER's own forces without the prior written consent of SCDOT as set forth in the SCDOT DBE Supplemental Specification.
- (4) The PROPOSER's Final DBE Committal Sheet, signed quotes, and all DBE executed subcontracts are to be submitted to the SCDOT within ~~45~~ 180 calendar days from the "Notice To Proceed #1." If the PROPOSER fails to meet the ~~45~~ 180 calendar day deadline, SCDOT shall withhold progress payments until the Final DBE Committal Sheet is submitted.
- (5) If the Final DBE Committal Sheet falls short of the DBE contract goal, the PROPOSER shall submit good faith efforts documentation in accordance with Part A of the DBE Supplemental Specification. This information is due within three (3) business days following the due date of the Final DBE Committal Sheet. If upon review of the Final DBE Committal Sheet, good faith efforts documentation and, if necessary, the findings of the Reconsideration Panel, the PROPOSER fails to meet the contract DBE goal or demonstrate good faith, the SCDOT will withholding monthly progress payments until compliance with DBE contract goal or PROPOSERs good faith efforts have been accepted by SCDOT.

### c. Progress Review Meetings / Monthly Updates

- (1) Implementation of the PROPOSER's DBE Utilization Plan shall be a discussion point during each progress review meeting (as required in the Agreement) until such time as the SCDOT deems it a closed issue. The PROPOSER's DBE liaison officer shall attend all progress review meetings until such time the issue is closed. At each progress review meeting, the DBE liaison officer shall provide a summary of the PROPOSER's progress towards implementing the DBE Utilization Plan as well as provide an updated DBE Committal sheet.
- (2) The PROPOSER shall provide the SCDOT monthly updates of its progress in accomplishing the DBE Utilization Plan. Monthly updates must include a copy of the latest committal sheet, signed quotes and copies of executed DBE subcontracts. The SCDOT's approval date of the DBE Utilization Plan will establish the date for which monthly updates are required of the PROPOSER.
- (3) The SCDOT, at its discretion, may withhold progress payments if the PROPOSER fails to submit monthly updates or any other submittal

**EXHIBIT 5 – SPECIAL PROVISIONS**

requirement on time or if the SCDOT believes the efforts of the PROPOSER in implementing the DBE Utilization Plan are insufficient.

d. PROPOSER's Obligation Post DBE Committal

- (1) **Once a firm is listed on the DBE Committal sheet, the PROPOSER shall administer the subcontract with the firm in accordance with the instructions provided in Part B of the SCDOT DBE Supplemental Specification.**
- (2) It is the PROPOSER's responsibility to comply with all elements of the SCDOT's DBE Program and to continuously pursue DBE participation as the project progresses. If the PROPOSER's Final DBE Committal Sheet and good faith efforts fall short of meeting the project goal and/or payments to committed DBE firms were less than the committed amounts, SCDOT may impose one of the sanction set forth under Part B of the SCDOT DBE Supplemental Specifications.
- (3) PROPOSER, for itself, for its design build team, and for its subcontractors and suppliers, whether certified DBE firm or not, commits to complying fully with all federal and state DBE provisions and agrees to assume these contractual obligations and to bind the design build team contractually to the same at the PROPOSER's expense.

**(14) SECTION 107: LATE DISCOVERY OF ARCHAEOLOGICAL/HISTORICAL REMAINS ON FEDERAL AID PROJECTS AND APPROVAL OF DESIGNATED BORROW PITS:**

See attached Supplemental Specification dated **August 7, 1991** in **Exhibit 7**.

**(15) SECTION 107: REQUIREMENTS FOR FEDERAL AID CONTRACTS WHICH AFFECT SUBCONTRACTORS, DBE HAULERS, MATERIAL SUPPLIERS AND VENDORS:**

See attached Supplemental Specification dated **March 1, 2010** in **Exhibit 7**.

**(16) SECTION 107: SPECIFIC EQUAL EMPLOYMENT OPPORTUNITY RESPONSIBILITY TRAINING SPECIAL PROVISIONS:**

See attached Supplemental Specification entitled "Specific Equal Employment Opportunity Responsibilities Training Special Provisions" dated **August 20, 1975**, revised **April 1, 2004**. In **Exhibit 7**.

The Supplemental Specification states "...the contractor will be reimbursed 80 cents per hour of training given an employee on this contract in accordance with an approved training program." The Contractor is advised that the Department will not accept bids with any unit price other than \$0.80/Hr for the item: ON-THE JOB TRAINEE. Bids that are submitted with any other unit price will be corrected by the Department to \$0.80/Hr, and the Grand Total bid amount adjusted accordingly.

**(17) SECTION 107: DBE PARTICIPATION:**

The Bidder is encouraged to use DBE subcontractors on this project. All DBE participation shall be reported to the RCE on the DBE Quarterly Report.

**(18) SECTION 107: CONTRACT PROVISION TO REQUIRE CERTIFICATION AND COMPLIANCE CONCERNING ILLEGAL ALIENS**

## EXHIBIT 5 – SPECIAL PROVISIONS

By submission of this bid, the bidder as the prime contractor does hereby agree:

- a. to certify its compliance with the requirements of Chapter 14 of Title 8 of the S.C. Code of Laws regarding Unauthorized Aliens and Public Employment;
- b. to provide SCDOT with any documents required to establish such compliance upon request; and
- c. to register and participate and require agreement from subcontractors and sub-subcontractors to register and participate in the federal work authorization program to verify the employment authorization of all new employees, or to employ only workers who supply the documents required pursuant to S.C.Code 8-14-20(B)(2).

**(19) SECTION 107: CRANE SAFETY:**

See attached Supplemental Specification dated August 1, 2013 in Exhibit 6.

**(20) SECTION 107: REQUIRED MEDIA NOTIFICATION FOR CONSTRUCTION PROJECTS:**

Contractors are encouraged to cooperate with the news media since all projects are constructed with public funds. Because the scope of this project will cause disruption of normal traffic flow, the Contractor is required to notify the public, in a timely manner, of disruptive activities such as lane closures.

The Contractor is required to utilize area media to accomplish public notification of traffic disruptions.

The Contractor is required to deal directly with the news media and all reasonable efforts should be made to cooperate with the media. However, the safety, security and construction schedule on site should not be disrupted in order to accomplish this. The Contractor may coordinate these activities with and receive guidance from the SCDOT Public Affairs Office.

**(21) SECTION 107: PERMITS:**

All permits necessary for completion of this project shall be procured by the Contractor. Failure to adequately comply with the provisions of permits or any other requirements from the permitting agencies will result in the stoppage of contract operations until corrective actions have been taken.

Fines assessed by permitting agencies to the Department as the result of the Contractor's non-compliance or violation of said permit provisions will be paid by the Department and subsequently deducted from the Contractor's monthly pay estimate.

**(22) SECTION 107: COORDINATION OF UTILITY RELOCATION WORK WITH HIGHWAY CONSTRUCTION:**

As it is not economically feasible to complete the rearrangement of all utility conflicts in advance of the highway construction, such rearrangements may be underway concurrently with construction.

***It shall be the responsibility of the contractor to inspect the site for potential utility conflicts.***

It is the responsibility of the Contractor to call Palmetto Utility Protection Service at **811** or 1-888-721-7877 three (3) days prior to work so that existing utilities can be properly marked.

**(23) SECTION 108: PARTNERING:**

**(A) Covenant of Good Faith and Fair Dealing**

This Contract imposes an obligation of good faith and fair dealing in its performance and enforcement.

The Contractor and Department, with a positive commitment to honesty and integrity, agree to the following mutual duties:

- (1) Each will function within the laws and statutes applicable to their duties and responsibilities.
- (2) Each will avoid hindering the other's performance.
- (3) Each will proceed to fulfill its obligations diligently.
- (4) Each will cooperate in the common endeavor of the Contract.

**(B) Partnering**

The Department encourages the foundation of cohesive partnering with the Contractor and its principle subcontractors and suppliers. This partnering is not a legal partnership as defined by South Carolina law. Partnering will be structured to draw on the strengths of each organization to identify and achieve reciprocal goals. The objectives are effective and efficient contract performance and completion within budget, on schedule, and in accordance with the Contract.

The establishment of a partnering charter will not change the legal relationship of the parties to the contract nor relieve either party from any of the terms of the Contract.

Any cost associated with effectuating partnering will be agreed to by the Department and the Contractor and will be shared equally between them.

**(24) SECTION 108: CRITICAL PATH METHOD CONSTRUCTION SCHEDULES:**

See attached **Construction Schedules** Supplemental Specification dated **November 4, 2013** **March 1, 2007** in **Exhibit 6**. The attached specification is hereby modified by changing the first sentence in the section entitled "Submission, Review, and Acceptance Process – Monthly Updates" to the following:

"Monthly updates shall be made no later than 15 days following the most recent estimate period end date and shall have a data date the same as the most recent estimate period end date."

**(25) SECTION 108: FAILURE TO COMPLETE THE WORK ON TIME**

Paragraph 1 of **Section 108.9** is hereby replaced with the following:

If the Contractor fails to substantially complete the work by the contract completion date, the Contractor is liable for liquidated damages. Liquidated damages will be assessed for each day beyond the contract completion date that work items are not completed. This includes the application of thermoplastic, raised pavement markers and grassing. Days to be charged for liquidated damages will not stop due to seasonal restrictions. The daily liquidated damages rate is determined from the following schedule. The date of substantial completion is determined by the RCE.

**(26) SECTION 109: PAYMENT SCHEDULE**



**EXHIBIT 5 – SPECIAL PROVISIONS**

Subsection 109.7 of the SCDOT 2007 Standard Specifications for Highway Construction is replaced as follows:

Pursuant to the **Critical Path Method Construction Schedules** Supplemental Specification dated **November 4, 2013** ~~March 1, 2007~~, submit the Critical Path Method (CPM) schedule within 30 days of award. Once accepted by SCDOT, the project’s initial baseline cost loaded CPM will be used for SCDOT budget purposes and the contractor will not be paid in excess of the cumulative amount shown on the schedule through each payment date; regardless of what subsequent monthly updates indicate. For example, see chart below:

Pay period ending	12/16/11	1/16/12	2/16/12	3/16/12	4/16/12	5/16/12
Baseline CPM Planned Payout in Millions (Cumulative to Date)	2.0 (2.0)	3.0 (5.0)	3.0 (8.0)	4.0 (12.0)	4.0 (16.0)	3.0 (19.0)
Actual work performed (Cumulative to Date)	1.5 (1.5)	2.0 (3.5)	3.5 (7.0)	6.0 (13.0)	3.0 (16.0)	4.0 (20.0)
Payout by SCDOT (Cumulative to Date)	1.5 (1.5)	2.0 (3.5)	3.5 (7.0)	5.0 (12.0)	4.0 (16.0)	3.0 (19.0)

Partial payment estimates will be generated in SiteManager (computerized construction management system) based on actual quantities installed. If actual quantities installed exceed the cumulative schedule amount to date, a negative adjustment will be made in SiteManager to adjust the pay as necessary. For previous work exceeding the schedule amount, payments will be released as work progresses and payouts fall below the scheduled cumulative amount, never to exceed the cumulative scheduled amount through that pay period.

If significant contract changes are necessary, and upon approval by the SCDOT, a re-baseline to the initial CPM will be allowed per the CPM schedule specification and the payout schedule may be adjusted accordingly.

All subcontractors must be paid in accordance with the Prompt Payment Clause (Supplemental Specification dated January 5, 2012) for the quantities used to generate the partial payment estimates. In instances where a payout by SCDOT is less than the actual work installed under a given estimate, the Prompt Payment Clause is hereby amended to require full payment to all subcontractors, for work complete, within 7 days of receipt of said SCDOT payout.

Partial Payments will be made no more than once each month as the work progresses. The monthly partial payment periods end at the end of the day **on the last day of each month.** ~~the following dates for the respective Engineering Districts:~~

- ~~• Engineering District Nos. 2, 3, and 5 – Last day of each month.~~
- ~~• Engineering District Nos. 1, 4, 6, and 7 – 16<sup>th</sup> day of each month.~~

**(27) SECTION 109: REFERENCES TO UNIT PRICING:**

Any references in the contract documents to unit price, measurement, and payment, are typical references for design-bid-build contracts and are not applicable to the extent they effect payment on Design-Build contracts. The Design-Build contractor’s schedule of values shall provide sufficient detail to compare work progress to the contractor’s schedule and determine appropriate periodic payments.

**EXHIBIT 5 – SPECIAL PROVISIONS**

**(28) SECTION 109: RETAINAGE**

If the Contractor's progress is judged to be delinquent or portions of the work are defective, the Department reserves the right to withhold retainage. The total amount retained will be sufficient to cover anticipated liquidated damages and the cost to correct defective work.

**(29) SECTION 109: PROMPT PAYMENT CLAUSE:**

See attached Supplemental Specification dated **January 5, 2012** in **Exhibit 6**.

**(30) SECTION 109: FUEL ADJUSTMENT:**

No fuel adjustment will be made on this Project.

**(31) SECTION 202: RECLAIMING EXISTING ROADWAY:**

**Description:**

This work consists of the restoration of paved areas. These areas are typically shown as hatched areas on the plans when outside the construction limits.

**Materials:**

None

**Construction Requirements:**

- 1.) Asphalt Pavement with Earth Base: Remove and dispose of areas of pavement shown as hatched areas on the plans. Grade the area to properly drain. Seed the area in accordance with Section 810.
- 2.) Asphalt Pavement with Stone Base: Remove and dispose of areas of pavement and base shown as hatched areas on the plans. Grade the area to properly drain. Seed the area in accordance with Section 810.
- 3.) Earth roadway or Bituminous Surfacing with Earth Base: Scarify existing areas of roadway. Grade the area to properly drain. Seed the area in accordance with Section 810.
- 4.) Bituminous Surfacing with Stone Base: Remove and dispose of areas of pavement and base shown as hatched areas on the plans. Grade the area to properly drain. Seed the area in accordance with Section 810.

Suitable materials may be used for embankment construction on the project. In the event that removed materials are used for embankment construction a corresponding deduction in Unclassified Excavation will be made by the Resident Construction Engineer.

**Measurement:**

Removed asphalt pavement greater than 2 inches in depth will be measured by the square yard. Removed bituminous surfacing with stone base will be measured by the cubic yard. Removed stone base will be measured by the cubic yard. Scarified areas will not be measured for payment.

**Payment:**

Removed asphalt pavement which is greater than 2 inches in depth will be paid at the unit price bid for Removal and Disposal of Existing Asphalt Pavement. Removed bituminous surfacing with stone base will be paid for at the unit price bid for Unclassified Excavation. Removed stone base will be paid for at the unit bid price for Unclassified Excavation. No payment will be made for scarifying earth roadway or bituminous surfacing with earth base. No separate or additional payment will be made for grading necessary to obtain proper drainage.

**(32) SECTION 202: STAGED REMOVAL OF EXISTING BRIDGES:**

For existing bridges that will be removed in stages, maintain stability of the existing structure at all times while traffic is on the bridge. At a minimum, replace tie rods after removal of any slab sections and maintain bracing on the existing piles at all times while traffic is on the bridge.

**(33) SECTION 202: REMOVAL AND DISPOSAL OF STRUCTURES CONTAINING STRUCTURAL COMPONENTS WITH LEAD-BASED PAINT:**

The existing structures shall be removed and disposed of by the Contractor in accordance with Subsection 202.4.2 of the Standard Specifications except as amended herein, or by accompanying Special Provisions.

The Contractor's attention is called to the fact that this project may require removal and disposal of structural components containing lead-based paints. Removal and disposal of structural components containing lead-based paints shall comply with all applicable Federal (EPA, OSHA & DOT) and State requirements for lead as waste, lead in air, lead in water, lead in soil, and worker health and safety. The requirements include but are not limited to the following:

1. Federal Resource Conservation and Recovery Act (RCRA) – Regulates when lead is present in a solid waste.
2. National Ambient Air Quality Standard (NAAQS) – EPA regulates airborne lead as a "criterion" pollutant. OSHA regulates the amount of lead in the air that workers breathe.
3. Clean Water Act (CWA) – Specifies the regulations for lead in water.
4. OSHA Lead Exposure in Construction, 29 CFR 1926.62.

**(34) SECTION 202: REMOVAL OF EXISTING GUARDRAIL:**

Section 202.4.4.3 applies on this project.

**(35) SECTION 202: REMOVAL OF STRUCTURES AND OBSTRUCTIONS:**

Section 202 is amended as follows:

Page 92 **Subsection 202.5**, item 5, second bullet:  
Change the words "brick sidewalk" to "concrete, brick or stone sidewalks".

**(36) SECTION 203: BORROW PITS ON LARGE PROJECTS:**

Borrow materials for this project shall not be obtained from wetlands, streams, or rivers.

**(37) SECTION 204: TEMPORARY SHORING WALL:**

Subsection 204.4.5.2 is amended to include the addition of the following section:

"The retaining wall system shall be designed to limit deformations (vertical and lateral displacements) that would affect the stability or performance of any adjacent structures (MSE walls, Bridge foundations, Pavement Structure, Approach Slabs, Embankment (stage construction), etc.). Deformations that must be limited shall include, but not be limited to, vertical settlement, sliding, bulging, bowing, bending, and buckling. Design criteria for

## EXHIBIT 5 – SPECIAL PROVISIONS

allowable deformations shall be dependent on the type of structure that will be influenced by any deformation of the temporary shoring wall. Regardless of the type of structure being retained, the deformation criteria shall not exceed 3 inches without acceptance from the Geotechnical Design Support Engineer. An instrumentation plan for monitoring deformations of the temporary shoring and any adjacent structure shall be submitted along with the shop drawings. The instrumentation plan shall indicate the maximum allowable deformations of the temporary shoring and adjacent structures. Typical instrumentation used for monitoring deformations are survey targets, settlement monuments, crack gages, inclinometers, and tilt monitors. The monitoring locations shall be established in a manner that they can be monitored consistently and obtain repeatable measurements for the entire construction period. A monitoring schedule that the Contractor will use during construction will also be included with the instrumentation plan. The Contractor shall submit periodic monitoring reports to the RCE in accordance with the approved instrumentation plan. Any changes in frequency of monitoring or report submittal must be sent to the Geotechnical Design Support Engineer for acceptance. If the initial instrumentation plan is found not to be documenting adequately the movements of the temporary shoring or adjacent structures, the Contractor will revise the instrumentation plan and resubmit the revised plan for review and acceptance. If the measured deformations exceed the maximum allowable deformations shown in the instrumentation plan, the Contractor will be required to stop work immediately, and at his own expense, correct the situation to the satisfaction of the Department prior to resumption of construction activities. Extended monitoring after construction may be required if adjacent structures have been affected by the construction. The extended monitoring of the adjacent structures shall continue until the structures have stabilized and the Department concurs with the results and conclusions of the monitoring report. All costs associated with developing the instrumentation plan, purchasing instrumentation, installing instrumentation, and monitoring of the instrumentation shall be included in the unit cost of the temporary shoring item.”

**(38) SECTION 208: FINE GRADING:**

Section 208 is amended as follows:

Page 131, **Subsection 208.5**, Paragraph 1, first sentence:  
Insert the word “paved” before the word “shoulders”.

**(39) SECTION 305: MAINTENANCE STONE:**

Maintenance Stone used on this project shall conform to the gradation requirements of Section 305, or to the gradation specified for Aggregate No. CR-14 in the Standard Specifications.

**(40) SECTION 401: PRICE ADJUSTMENT FOR LIQUID ASPHALT BINDER:**

No price adjustment for liquid asphalt binder will be made on this Project.

**(41) SECTION 401: HOT MIX ASPHALT (HMA) QUALITY ASSURANCE:**

Reference is made to the Supplemental Technical Specification “Hot Mix Asphalt (HMA) Quality Assurance.” For the purposes of applying this Supplemental Technical Specification, there will be no pay factor adjustment greater than 100% for any given lot. When applying pay factor adjustments of less than 100%, a unit price of \$75 per ton will be used.

**(42) SECTION 401: HOT-MIX ASPHALT RIDEABILITY:**

**EXHIBIT 5 – SPECIAL PROVISIONS**

Reference is made to the Supplemental Technical Specification “Hot-Mix Asphalt Rideability.” For the purposes of applying this Supplemental Technical Specification, there will be no pay factor adjustment greater than 100%. When applying pay factor adjustments of less than 100%, price Adjustments will be calculated based on \$75 per ton.

**(43) SECTION 401: TRANSPORTATION AND DELIVERY OF MIXES:**

See attached Supplemental Specification dated **July 1, 2010** in **Exhibit 6**.

**(44) DIVISION 600: MANUAL ON UNIFORM TRAFFIC CONTROL DEVICES:**

“The Contractor is hereby advised that the Department has adopted the MUTCD 2009 – Manual on Uniform Traffic Control Devices for use on all projects. All references to the South Carolina Manual on Uniform Traffic Control Devices (SCMUTCD) are hereby revised to read “MUTCD – 2009 Edition”.”

**(45) DIVISION 600: RULE ON WORK ZONE SAFETY AND MOBILITY:**

The Contractor is responsible for complying with the Rule on Work Zone Safety and Mobility. This Project is classified as **“intermediate”**. The Contractor shall submit a Traffic Management Plan in compliance with the Rule on Work Zone Safety and Mobility. See “Rule on Work Zone Safety and Mobility” in the Project Information section.

**(46) DIVISION 600, Etc.: ADHESIVELY BONDED ANCHORS AND DOWELS:**

See attached Supplemental Specification dated **September 1, 2008** in **Exhibit 6**.

This Supplemental Specification applies when Adhesively Bonded Anchors or Dowels are called for in the Plans or Detailed Drawings.

The following Standard Drawings have been identified as showing Adhesively Bonded Anchors or Dowels:

605-205-03	Temporary Concrete Barrier
605-210-04	Temporary Concrete Barrier
605-310-01	Temporary Concrete Barrier
605-315-00	Temporary Concrete Barrier
605-320-00	Temporary Concrete Barrier
605-325-00	Temporary Concrete Barrier
605-330-00	Temporary Concrete Barrier
651-105-00	Barrier Mounted Sign Post
657-100-00	Overhead Sign Support Roadway Bridges
722-105-01	Box Culvert (Used to connect headwall, wingwalls, and for extensions)
805-120-00	Guardrail (W Beam) Base Plate Connection
805-405-03	Guardrail (Tubular Beam) Bridge Railing
805-405-04	Guardrail (Tubular Beam) Bridge Railing
806-505-00	Fence (Ornamental Steel Picket)

It is the contractor’s responsibility to determine if Adhesively Bonded Anchors or Dowels are a part of the project, and to comply with the provisions of the Supplemental Specification.

**(47) DIVISION 600: EVALUATION OF RETROREFLECTIVITY:**

Within 20 days of initial application, the Contractor shall arrange for an independent party to evaluate the retroreflectivity of the pavement markings using a mobile retroreflectometer utilizing 30 meter CEN geometry. All lines shall be measured in both directions. The independent party conducting the measurements shall furnish directly to the Department a report detailing the average of the readings over one mile segments for each type of long

**EXHIBIT 5 – SPECIAL PROVISIONS**

line (white edgeline, white lane lines, yellow edgelines) along the length of the project. Average measurements shall also be provided along each ramp. Interstate mile markers may be used for beginning and ending points, with the first and last segments in each direction being less than one mile in length. The initial minimum retroreflectivity values shall be as follows:

Retroreflectivity (mcd/lux/m<sup>2</sup>)

<u>White</u>	<u>Yellow</u>
450	350

A second evaluation shall take place within 20 days prior to the end of the 180 day observation period. The evaluation method shall be the same as described above. The 180 day minimum retroreflectivity values shall be as follows:

Retroreflectivity (mcd/lux/m<sup>2</sup>)

<u>White</u>	<u>Yellow</u>
400	300

All markings failing to meet the initial minimum retroreflectivity requirements by more than 50 mcd/lux/m<sup>2</sup> shall be replaced immediately at the Contractor's expense. All markings failing to meet initial requirements by less than 50 mcd/lux/m<sup>2</sup> may be reevaluated at the time of the 180 day evaluation unless the defect causing the lower readings is obvious to the Engineer.

**(48) DIVISION 600: WORK ZONE TRAFFIC CONTROL TRAINING REQUIREMENTS FOR CONTRACTORS / SUBCONTRACTORS:**

See attached Supplemental Specification dated **September 1, 2013** in Exhibit 6.

**(49) SECTION 601: PENALTY FOR VIOLATING LANE CLOSURE RESTRICTIONS:**

The Contractor is advised that the Lane Closure Restrictions for US 701 outlined in the Work Zone Traffic Control Requirements will be strictly enforced. Should lane closures remain in place or not be completely removed by the time specified in the Traffic Control Special Provisions, a penalty will be assessed at the rate of **\$500 (Five hundred Dollars)** for each 1/4 hour interval (or any portion thereof). Should lane closures remain in place or not be completely removed for a period of longer than one hour beyond the time specified by the Traffic Control Special Provisions the penalty will increase to **\$1,000.00 (One Thousand Dollars)** for each 1/4 hour interval (or any portion thereof).

See attached Supplemental Specification dated **January 3, 2013** in Exhibit 6.

**(50) SECTION 609: HIGH PRESSURE WATER METHOD FOR REMOVAL OF PAVEMENT MARKINGS:**

See attached Supplemental Specification dated **July 2, 2009**, in Exhibit 6.

**(51) DIVISION 700: DYNAMIC LOAD TESTING WITH PILE DRIVING ANALYZER AND STATIC LOAD TESTING:**

The Contractor will be responsible for dynamic and static load testing of all foundations if required by design. See **Exhibit 4b**, "Project Criteria – Structures," for additional information.

**EXHIBIT 5 – SPECIAL PROVISIONS**

- (52) **SECTION 701: CONCRETE BATCHING AND MIXING:**  
See attached Supplemental Specification dated **April 5, 2010** in **Exhibit 6**.
- (53) **SECTION 701: NON-CONFORMING CONCRETE:**  
For purposes of applying the reduced payment and below strength provisions of Subsection 701.2.12.4 of the Standard Specifications, a unit price of \$750 per cubic yard will be used.
- (54) **SECTION 711: PILE AND DRIVING EQUIPMENT DATA FORM:**  
Pile and Driving Equipment Data Form is included in **Exhibit 6**.
- (55) **SECTION 712: DRILLED SHAFTS:**  
Drilled Shaft Forms are included in **Exhibit 6**.
- (56) **SECTION 714: PIPE END TREATMENTS (2/5/2010)**  
**REFERENCE: SCDOT Supplemental Technical Specification SC-M-714**

**DESCRIPTION:**

For exposed pipe culvert ends, provide an end treatment in accordance with this special provision.

**MATERIALS:**

Rigid pipe culvert is Reinforced Concrete Pipe (RCP: 714-205-00). Flexible pipe culvert is either Spiral Ribbed Aluminum Pipe (SRAP: 714-610-00), High Density Polyethylene pipe (HDPE: 714-705-00), or Corrugated Aluminum Alloy Pipe (CAAP: 714-605-00).

Use minimum Class B riprap for pipe up to 84" diameter. Use minimum Class C riprap for pipe 84" diameter or larger.

Use minimum Class 4000 concrete (4000P for precast).

Use ASTM A-706 grade 60, low-alloy steel deformed rebar.

Use minimum AASHTO M-196 Alclad 3004-H32 alloy aluminum.

Use Type M Mortar Grout unless specified otherwise.

**CONSTRUCTION REQUIREMENTS:**

Use one of the following end treatments as specified in the plans or special provisions:

## EXHIBIT 5 – SPECIAL PROVISIONS



For all exposed crossline pipe ends, when an end treatment is not specified in the plans, use **Pipe Riprap Protection** (804-3xx-xx). For flexible pipe larger than 24" diameter, install pipe straight headwall, pipe end structure, flared end section, or wingwall section in addition to riprap. For all exposed driveway pipe ends where no end treatment is specified in the plans, use **Pipe Riprap Protection** (804-3xx-xx) unless directed otherwise by the Engineer.



Use **Beveling of Pipe End** (719-610-00) when specified in the plans or special provisions. Beveled ends may only be used on flexible pipe up to 24" diameter and on rigid pipe up to 60" diameter. When beveling of pipe ends is specified on flexible pipe larger than 24" diameter, install pipe straight headwall, pipe end structure, flared end section, or wingwall section. Use factory fabricated beveled ends for all pipe types unless approved by the Engineer.



Use **Pipe Straight Headwall** (719-605-00) when specified in the plans or special provisions. Use straight headwall only in locations where pipe exposed end does not face the direction of traffic.



## EXHIBIT 5 – SPECIAL PROVISIONS



Use **Pipe End Structure** (719-615-00) when specified in the plans or special provisions. Use pipe end structure in locations where pipe exposed end faces the direction of traffic. Pipe end structures may be used in other locations if approved by the RCE.



Use **Pipe Flared End Section** when specified in the plans or special provisions.



Use **Pipe Wingwall Section** when specified in the plans or special provisions.

Completely seal interface between pipe and end treatment with grout. If bricks or shims are used to place pipe, take care to remove all air pockets and voids when grouting.

For systems not designed in the SCDOT Standard Drawings, provide shop drawings, installation procedure and design calculations for review by RCE. Design must include provision to control erosion around the structure and prevent the separation of the end treatment from the pipe system. Design must provide for a proper seal at all construction joints including the interface between the pipe and the structure. Design must be self supporting and not induce any additional loads on the pipe. Submit designs for consideration as new standard drawings to the Design Standards Engineer at the address listed in the SCDOT Standard Drawings book.

## EXHIBIT 5 – SPECIAL PROVISIONS

### **MEASUREMENT:**

Measure pipe in accordance with SC-M-714

Measure end treatments in accordance with Standard Specifications, Standard Drawings, or Special Provisions.

### **PAYMENT:**

Beveling of pipe ends will be in addition to the standard pipe pay item. Payment for the item Beveling of Pipe Ends includes all labor required to factory (or field, if approved) fabricate a bevel on one end of pipe.

Pipe culvert and end treatments, measured as provided in **SC-M-714 Subsection x.4**, are paid for at the contract unit price for the respective items, which price and payment is compensation for furnishing all material, labor, equipment, tools including hauling and placing all pipe sections and materials, excavation of the entire standard trench, bedding, and pipe backfill as described in the measurement section (both structural and embankment backfill in this region), removal of existing pipe to be replaced, constructing pipe joints, removal of old end treatments, cleaning out pipe, disposal of surplus materials, all visual inspection, and all incidentals necessary to complete the work.

Add the following paragraph to SC-M-714 subsections x.5:

Payment for riprap and geotextile for erosion control under riprap as measured in subsection x.4 includes all direct and indirect costs and expenses necessary to complete the work.

### **(57) SECTION 714: SMOOTH WALL PIPE:**

#### **REFERENCE:**

**SCDOT Supplemental Technical Specification SC-M-714**

#### **DESCRIPTION:**

When bid items for smooth wall pipe are listed in the EBS file and/or proposal, the SCDOT will allow the use of reinforced concrete pipe, spiral ribbed aluminum pipe or high density polyethylene pipe in accordance with the specifications found in SC-M-714 (latest edition), the Standard Drawings, and this Special Provision. The plans may indicate reinforced concrete pipe only and are hereby superseded by this Special Provision.

#### **MATERIALS:**

Smooth wall pipe is either Reinforced Concrete Pipe (RCP: 714-205-XX), Spiral Ribbed Aluminum Pipe (SRAP: 714-605-XX), or High Density Polyethylene pipe (HDPE: 714-705-XX) as described in SCDOT Supplemental Technical Specification SC-M-714 and in the SCDOT Standard Drawings. Use smooth wall pipe culvert from manufacturers listed on Qualified Product Lists 30, 68, or 69. No value engineering application is required in order to use alternate pipe.

For the following counties: Berkeley, Beaufort, Charleston, Colleton, Dorchester, Georgetown, Horry, and Jasper, provide pipe joints meeting AASHTO M 315 for RCP or passing the 13 psi pressure test as indicated on the QPL for SRAP or HDPE. Take care to properly lubricate and equalize pipe gaskets as indicated in the **SCDOT Standard Drawings** and **SC-M-714** to prevent gaskets from "rolling" during installation. For all other counties, provide pipe joints meeting AASHTO M 198, M 315, or passing the minimum 10 psi pressure test unless specific pipe joints are indicated in the plans or special provisions.

No other pipe type will be accepted as an alternate.

## EXHIBIT 5 – SPECIAL PROVISIONS

### CONSTRUCTION REQUIREMENTS:

Use only pipe that conforms to the minimum and maximum fill height limitations indicated on the appropriate standard drawing. Unless indicated otherwise in the plans, determine pipe fill height based on the following formula:

Fill Height = Elevation (top of curb or max grade above pipe) – Elevation (pipe crown)

For all locations where new pipe is being attached to an existing system, use one of the following options:

1. Any existing pipe may be extended using any acceptable alternate pipe type by using a drainage structure at the interface between the different pipe types. The drainage structure\* may consist of standard junction boxes, manholes, catch basins, drop inlets, or circular drainage structures detailed on **SCDOT Standard Drawings**. For larger diameter pipe, custom drainage structures may be required. Field cut existing pipe to remove damaged joint (if applicable) and install new drainage structure at the field cut interface. Always fully clean existing pipe and pipe joints before installing joint sealant or gaskets and attaching new pipe.
2. For locations where existing pipe properties cannot be directly matched, use a custom designed interface\* (concrete collar, proprietary mastic wrap, custom coupling band, etc.) appropriate to interface the existing pipe to the new pipe of the same type. Submit interface drawings and design for review by the Engineer of Record and the Design Standards Engineer. Always fully clean existing pipe and pipe joints before installing joint sealant or gaskets and attaching new pipe. Replace existing pipe that has joint damage before connecting new pipe to the system.
3. Any existing pipe may be extended using new pipe with the same joint profile and wall properties of the existing pipe. Always fully clean existing pipe and pipe joints before installing joint sealant or gaskets and attaching new pipe. Verify\* the following parameters before ordering new pipe:
  - a. For RCP to RCP, confirm wall thickness, joint profile shape, and compatibility with existing manufacturer's pipe. Replace existing pipe that has joint damage before connecting new pipe to the system.
  - b. For SRAP to SRAP, replace existing pipe that has joint damage before connecting new pipe to the system.
  - c. For HDPE to HDPE, confirm the manufacturer of the existing pipe and the joint compatibility with the new pipe. Provide a new gasket when connecting to existing spigot end of HDPE pipe. Replace existing pipe that has joint damage before connecting new pipe to the system.
  - d. For CAAP to CAAP, confirm the type and size of end corrugations of the pipe. When existing pipe has full helical corrugations, provide new connecting pipe with one end fully helical and fully helical coupling band. When end corrugation size does not match the corrugation size shown on SCDOT Standard Drawings, provide a drainage structure (described above) at the interface. Replace existing pipe that has joint damage before connecting new pipe to the system. Do not install CAAP as smooth wall pipe; however, use these requirements when plans specify installing new CAAP.

The **RCE** will verify that connections between existing pipe and new installed pipe have been handled with one of the options listed above. Repair or replace all existing to new joint interfaces that do not meet the requirements above at no additional cost to **SCDOT**.

In all installations, provide the RCE with a complete pipe table indicating the following: Plan Pay Item, Plan Pipe Description, Plan Quantity, Installed Pipe (diameter, type, class/gage), Installed Quantity, and description of interface used to join new pipe to existing pipe for each occurrence.

**EXHIBIT 5 – SPECIAL PROVISIONS**

In cases where 2 or more different pipe types are installed, provide a copy of the proposed installation layout on the drainage/plan sheets to the RCE indicating which pipe is installed at each location.

**MEASUREMENT:**

Measure smooth wall pipe in accordance with methods specified in SC-M-714 for the pipe material installed.

\*No measurement will be made for drainage structure, designed interface, or field verification performed at each interface between existing pipe and new pipe unless drainage structure/interface is specified in the plans.

**PAYMENT:**

Payment will be made for smooth wall pipe regardless of the type of material installed. Payment for smooth wall pipe is as specified in SC-M-714 for the pipe material installed.

\*Include all costs for work related to connecting new pipe to existing pipe in the unit bid price of the new pipe. This connection work includes: drainage structure at the interface, custom designed interface, field verification of existing pipe and compatibility with new pipe, new gaskets, new joint sealant, new coupling bands, removal, and disposal of damaged sections of existing pipe.

ITEM NO.	DESCRIPTION	UNIT
7143XXX	X" SMOOTH WALL PIPE	LF
7143XXX	X"x X" SMOOTH WALL PIPE CUL.TEE	EA
714XXXX	X" x X" SMOOTH WALL PIPE CUL.WYE	EA
7144XXX	X" SMOOTH WALL PIPE X DEG BEND	EA
7144XXX	SMOOTH WALL PIPE INCR.- X" TO X"	EA

**(58) SECTION 720: DETECTABLE WARNING SURFACE:**

Description:

Detectable warnings are an Americans with Disabilities Act (ADA) requirement for the purpose of detecting the boundary between the sidewalk and the street. The detectable warning surface is a feature built in or applied to walking surfaces to warn visually impaired people where to stop. Generally, they are used where the sidewalk crosses or adjoins a vehicular way and the two surfaces are not separated by a curb, rail or other element excluding un-signalized driveway crossings. Truncated domes are the only detectable warning surface allowed along with a visually contrasting surface.

Materials:

The detectable warning surface consists of raised truncated domes with a base diameter of nominal 0.9 –1.4 inch, a height of nominal 0.2 inch and a center-to-center spacing of nominal 1.6 –2.4 inches. The pattern for the domes is a square pattern arranged in a parallel alignment. Minimum space between the domes at their base is 0.65 inch measured along any line of domes uniform over the entire detectable warning surface. See Standard Drawing 720-905-01 for details. Detectable warning surfaces must be listed on the Department’s Approval Sheet prior to installation.

Detectable warning surfaces visually contrast with the adjoining surfaces. The SCDOT has selected the color “safety yellow” (Federal Number 33538) to meet this requirement. If a specific project requires another color other than safety yellow, the color selected will contrast either light-on-dark or dark-on-light.

**EXHIBIT 5 – SPECIAL PROVISIONS**

Construction:

Cast detectable warnings into the newly poured concrete ramps. If existing ramps are retrofitted, use the surface mount type of detectable warning. See Standard Drawing 720-905-02, 720-910-01 thru 04 for details.

Follow the manufacture's instructions for the proper installation of detectable warning surfaces. Provide copies of the manufacturer's literature to the Engineer to verify material and construction procedure compliance.

Method of Measurement:

The Engineer will measure detectable warnings by the square foot.

Basis of Payment:

Payment includes all costs for labor, materials, and incidentals to construct the detectable warnings in accordance with this Special Provision, Standard Drawings, and the manufacture's requirements. The bid item, description, and unit are as follows:

<b>Item number</b>	<b>Description</b>	<b>Unit</b>
7204900	DETECTABLE WARNING SURFACE	SF

- (59) **SECTION 727: CROSSHOLE SONIC LOGGING OF DRILLED SHAFT FOUNDATIONS:**  
Crosshole Sonic Logging (CSL) Testing is required for all drilled shafts. SCDOT shall be responsible for all CSL Testing.

- (60) **SECTION 805: GUARDRAIL END TERMINAL - TYPE T:**  
The Contractor's attention is directed to the plans which call for Guardrail End Terminal Type T. These end treatments shall meet the requirements of NCHRP 350. The Contractor shall select a terminal listed on the Qualified Products List for "End Terminal - Type T". This list is maintained by the Materials and Research Engineer. Currently, the following two terminals are listed on the Qualified Products List:

***ET - PLUS***  
***SKT - 350***

The Contractor shall construct the end terminal in accordance with the manufacturer's specifications for a four tube system. End Terminals are to be supplemented with a W18-1R-30 or W18-1L-30 sign as appropriate. The sign is to be fabricated from Type III sheeting with a high tack adhesive and attached directly to the end terminal without the aluminum blank. All costs for the sign and installation are to be included in the price bid for Guardrail End Terminal Type T.

Note: The Melt does not meet the NCHRP 350 criteria.

- (61) **SECTION 805: HEIGHT OF W-BEAM GUARDRAIL:**  
The Standard Drawings for w-beam guardrail are hereby revised as follows:

Install standard w-beam guardrail at a minimum height of 27.75 inches, measured from the ground line to the top of the rail at the front face of the rail. A construction tolerance of three inches above this height is allowed. Ensure the final height of w-beam guardrail is within the acceptable range of 27.75 inches to 30.75 inches.

**(62) SECTION 802: GEOCOMPOSITE WALL DRAIN DATED MAY 6, 2003:**

**1.0 DESCRIPTION**

A geocomposite wall drain is a prefabricated drain system that is used to provide drainage behind retaining walls. The geocomposite drain consists of a flexible plastic drainage core bonded to a non-woven geotextile. Geocomposite wall drains shall be placed continuously along the back of the wall as shown in the plans or as otherwise directed by the Engineer. The Contractor shall furnish all necessary labor, equipment, and materials and perform all operations necessary for the installation of geocomposite wall drains in accordance with the details shown on the plans and with the requirements of this specification.

**2.0 ACCEPTANCE CRITERIA**

The Contractor shall supply to the Engineer, prior to placing the material, certified test results of those tests specified herein from a recognized laboratory. Acceptance will be based on the test results meeting the geocomposite system properties, drainage core properties, and geotextile properties stated in this specification. The Engineer shall submit the certified test results to the Research and Material Engineer for acceptance. Test data shall be no more than one year old at the time it is furnished to the Department. Geocomposite wall drains shall not be installed until the material certification is received and approved by the Research and Materials Engineer. The Department reserves the right to sample and test any of the materials used in the geocomposite wall drain system.

Labeling, shipment, and storage of the geocomposite wall drain materials shall follow ASTM D 4837. Product labels shall clearly show the manufacturer or supplier name, style number, and roll number. Geocomposite rolls shall be wrapped with a material that will protect the geocomposite drain from damage due to shipment, water, sunlight, and contaminants. The protective wrapping shall be maintained during periods of shipment and storage.

**3.0 MATERIAL**

The geocomposite wall drain shall be prefabricated type made up of a lightweight, high impact polymeric drainage core bonded to the geotextile at intervals not exceeding 1.5 inches. The geocomposite wall drain shall be solid backed allowing drainage of water on only one side. The non-woven geotextile is thermal (heat) bonded or fungicide glue bonded to the polymeric drainage core. The geocomposite product sheets or rolls shall have a minimum width of 3 feet with a minimum coverage area of 40 square feet. A geotextile flap shall be provided along all drainage core edges. This flap shall be of sufficient width for sealing the geocomposite drain edge to prevent soil intrusion into the drainage core during and after installation. The geotextile shall cover the full length of the drainage core.

The wall drainage system shall meet the following geocomposite system properties in addition to the individual component properties of the polymeric drainage core and the non-woven geotextile. All numerical values listed in the required property tables shown below represent minimum average roll values (MARV) per ASTM D 4759 unless indicated otherwise. Values for the weaker principal direction should be used. Testing shall be performed in accordance with the methods referenced in this specification. Sampling of lots shall be in accordance with ASTM D 4354.

**GEOCOMPOSITE SYSTEM PROPERTIES**

**EXHIBIT 5 – SPECIAL PROVISIONS**

<b>TEST</b>	<b>METHOD</b>	<b>LIMIT</b>
Flow Capacity (gpm/ft. width) At a hydraulic gradient of 1.0 and a minimum normal stress of 3600 psf (Normal load maintained for 300 hours or until equilibrium)	ASTM D 4716	14

**DRAINAGE CORE PROPERTIES**

<b>TEST</b>	<b>METHOD</b>	<b>LIMIT</b>
Thickness (inches)	ASTM D 1777	0.3 minimum / 0.5 maximum
Compressive Strength (psf) At 20% Deformation (10,000 hour minimum duration)	ASTM D 1621	14,000

**GEOTEXTILE PROPERTIES**

<b>TEST</b>	<b>METHOD</b>	<b>LIMIT</b>
AOS (Equiv. U.S. Sieve)	ASTM D 4751	50 maximum average roll value
Permittivity (sec <sup>-1</sup> )	ASTM D 4991	1.0
Grab Tensile Strength (lbs.)	ASTM D 4632	80
Grab Tensile Elongation (%)	ASTM D 4632	50
Trapezoidal Tear Strength (lbs.)	ASTM D 4533	40
Puncture Strength (lbs.)	ASTM D 4833	50
Burst Strength (psi)	ASTM D 3786	150
Ultraviolet Stability (%) (Retained strength after 500 hours of exposure)	ASTM D 4355	70

**4.0 CONSTRUCTION REQUIREMENTS - GENERAL**

The Contractor shall check the geocomposite wall drain upon delivery to ensure that the proper material has been received. The geocomposite wall drain shall be protected during shipment and storage at the construction site from temperatures greater than 71° C, mud, dirt, debris, and any other environmental condition that may damage the material's physical property values. The wall drainage system shall be protected from direct sunlight in accordance with the manufacturer's recommendations.

The geocomposite wall drain will be rejected at the time of installation if it has defects, tears, punctures, flaws, deterioration, or damage incurred during manufacture, shipment, or storage. Torn or punctured sections shall be removed or repaired as directed by the Engineer. Any geocomposite wall drain damaged during manufacture, shipment, or storage shall be replaced by the Contractor at no additional cost.

If at any time the Engineer determines that the method of installation does not produce a satisfactory wall drainage system, the Contractor shall alter his method and/or equipment as necessary to comply with this specification.

The geocomposite wall drain shall be installed in accordance with the plans and specifications. The surface that the geocomposite drain will be placed against shall be cleaned by removing all soil, debris, and irregularities that will prevent intimate contact between the surface and the geocomposite drain. The geocomposite wall drain shall be secured to the wall using metal stick clips, adhesives, or as

## EXHIBIT 5 – SPECIAL PROVISIONS

recommended by the manufacturer. The geocomposite wall drain shall be installed so as to allow weepholes, as shown in the plans, to drain water from the drainage core and underdrain pipes.

All joints shall be formed by peeling or trimming the geotextile off the attached section to expose 3 inches of the drainage core. The drainage core of the second section being attached is then overlapped 2 inches over the first drainage core. The joint is then covered by reattaching the geotextile flap and securely fastening it to the lower geotextile by means of a continuous strip of 3 inch wide waterproof plastic tape. Each overlapping course shall be shingled in the direction of water flow. If joints cannot be formed by interlocking the cuspatations, then the drainage core should be butted together and covered with continuous, 6 inch wide geotextile. The geotextile fabric shall be centered over the joint and securely fastened to the two geocomposite drains with 3 inch wide waterproof plastic tape.

All exposed edges of the geocomposite wall drain shall be covered with geotextile by tucking and securing a minimum of 4 inches of geotextile behind the drainage core. This may be done by using the geotextile flaps at the edges or using a 12 inch wide continuous strip in the same manner, taping it to the exposed fabric 4 inches in from the edge with a continuous strip of 3 inch wide waterproof plastic tape, and folding the remaining geotextile and tucking it behind the drainage core edge.

If the geotextile is torn, perforated, or ripped during installation, it shall be patched or replaced as directed by the Engineer. The damaged section shall be cut out and replaced completely or repaired by placing a piece of geotextile over the damaged area and providing a minimum of 4 inches of overlap on all sides over the damaged area and secured with 3 inch wide waterproof plastic tape. Damaged drainage core sections shall be discarded and replaced. Any geocomposite wall drain damaged during installation shall be replaced or repaired by the contractor at no additional cost.

The underdrain pipes and free draining aggregate shall be placed as shown in the plans or as directed by the Engineer. A positive outlet for the water in the geocomposite drain shall be maintained at all locations. Weepholes shall not be sealed or made ineffective by the wall drain material. This may involve making a hole in the drainage core at the weephole location. The geotextile drainage filtration fabric used to envelop the underdrain system shall be tucked 6 inches behind the geocomposite drain and overlapped over the geocomposite drain a distance of 12 inches and continuously secured with 3 inch wide waterproof plastic tape.

Backfill shall be placed immediately over the geocomposite wall drain. The contractor shall backfill against the wall in a manner that does not damage the geocomposite drainage system. Care shall be taken to avoid excessive settlement of the backfill material. The geocomposite wall drain shall not be exposed for more than seven days prior to backfilling. Any geocomposite drainage system component that is damaged during the backfilling operation shall be replaced or repaired as directed by the Engineer.

### **5.0 METHOD OF MEASUREMENT AND BASIS OF PAYMENT**

Geocomposite wall drains will not be measured for payment. The cost of the geocomposite wall drain shall be included in the cost of the retaining wall or wall system where the drainage system is being installed.

#### **(63) SECTION 801: GEOTEXTILE FOR DRAINAGE FILTRATION:**

See attached Supplemental Specification dated **October 15, 1991** in **Exhibit 6**.



**EXHIBIT 5 – SPECIAL PROVISIONS**

**(64) SECTION 814: COLD APPLIED WATERPROOFING DATED MAY 29, 2003:**

**1.0 DESCRIPTION**

A cold applied waterproofing system may be used in lieu of the “Second Method” waterproofing. The cold applied waterproofing shall be placed along construction joints and contraction joints that are adjacent to soil. The cold applied waterproofing shall be placed continuously along the joints in the wall as shown in the plans or as otherwise directed by the Engineer. The Contractor shall furnish all necessary labor, equipment, and materials and perform all operations necessary for the installation of cold applied waterproofing system in accordance with the details shown on the plans and with the requirements of this specification.

**2.0 ACCEPTANCE CRITERIA**

The Contractor shall supply to the Engineer, prior to placing the material, certified test results of those tests specified herein. Acceptance will be based on the material test results meeting the properties stated in this specification. The Engineer shall submit the certified test results to the Research and Material Engineer for acceptance. Test data shall be no more than one year old at the time it is furnished to the Department. The waterproofing shall not be installed until the material certification is received and approved by the Research and Materials Engineer.

**3.0 MATERIAL**

The cold applied waterproofing system shall be a self-adhering membrane of rubberized asphalt integrally bonded to polyethylene sheeting. The material shall conform to the properties given in the table below.

<b>COLD APPLIED WATERPROOFING SYSTEM PROPERTIES</b>		
<b>TEST</b>	<b>METHOD</b>	<b>LIMIT</b>
Application Temperature Range (°F)	N/A	40 °F to 120 °F
Minimum Thickness (mils)	N/A	60
Pliability (180 bend over ¼" mandrel @ - 25 °F)	ASTM D 146	No Effect
Minimum Tensile Strength – Film (psi)	ASTM D 412 (Die C) Modified	4000
Minimum Elongation – Ultimate Failure of Rubberized Asphalt, (%)	ASTM D 412 (Die C) Modified	300
Minimum Puncture Strength – Membrane (Stretches by blunt object) (lbs.)	ASTM E 154	40
Minimum Puncture Strength – Film (in ounce tear) (lbs.)	ASTM D 781	250
Maximum Permeance – Perms (Grains/sq. ft./hr./in.Hg)	ASTM E 96 (Method B)	0.1
Maximum Water Absorption (% by weight)	ASTM D 570	0.2
Minimum Tensile Strength – Membrane (psi)	ASTM D 412 (Die C) Modified	250

**4.0 CONSTRUCTION REQUIREMENTS - GENERAL**

## EXHIBIT 5 – SPECIAL PROVISIONS

The Contractor shall check the cold applied waterproofing system upon delivery to ensure that the proper material has been received. All materials shall be delivered to the site in the original containers, plainly marked with the manufacturer's brand or label. The waterproofing materials shall be stored in a dry protected place. Manufacturer's recommendations for shipping and storage at the construction site shall be followed.

The waterproofing materials will be rejected at the time of installation if it has defects, tears, punctures, flaws, or damage incurred during manufacture, shipment, or storage. Any waterproofing materials damaged during manufacture, shipment, or storage shall be replaced by the Contractor at no additional cost.

The cold applied waterproofing shall be installed in accordance with the manufacturer's recommendations at the locations shown on the plans or as directed by the engineer. If at any time the Engineer determines that the method of installation does not produce a satisfactory waterproofing, the Contractor shall alter his method and/or equipment as necessary to comply with this specification.

### 5.0 METHOD OF MEASUREMENT AND BASIS OF PAYMENT

Cold applied waterproofing shall not be not be measured for payment. The cost of the cold applied waterproofing shall be included in the cost of the retaining wall or wall system where the waterproofing is being installed.

#### (65) SECTION 809: RIGHT OF WAY PLAT:

##### **Description:**

The Contractor by the "Substantial Work Complete" date shall prepare a right of way plat signed and sealed by a Professional Land Surveyor (PLS) licensed to practice in the state of South Carolina. The right of way plat shall be in accordance with the requirements of Section 49-460-A "General Property Survey" as outlined in the South Carolina "Standards of Practice Manual" for land surveyors. A copy of the plat will be recorded, by the Contractor, in the Register Mesne Conveyance (RMC) office of the county or counties in which the project resides. The Contractor will provide one copy of the plat on a full sized plan sheet(s) (22" X 36") and submit to the Resident Construction Engineer to be included in the as-built plans.

##### **Materials: Rebar Cap R/W Marker**

Materials used shall comply with those listed on SCDOT Standard Drawing No. 809-105-00.

##### **Construction Requirements:**

The PLS shall set right of way markers along all new right of way lines as well as along any present right of way being retained by the Department at intervals listed on the SCDOT Standard Drawings. Right of way markers shall not be placed at points common to side property lines and/or corners. In the event that the plan reflects a break in the right of way along a side property line the right of way marker will not be set without the side property line being retraced and established by way of survey. The PLS shall prepare a plat documenting the location of all right of way markers set and reflecting the as-built station and offset from the plan alignment. The plat shall show the entire project corridor as an enclosed strip or parcel of land to include the mainline and all side roads as defined on the project plan.

##### **Measurement and Basis of Payment:**

The item Right of Way Plat is paid on a lump sum (LS) basis; and therefore, there is no specific measurement for this item. The unit price bid for Right of Way Plat shall include all costs for labor, materials, equipment, services of a PLS and any related fees or costs associated with producing a plat, recording the plat at the RMC office, and all required copies. Each marker placed in accordance with the Standard Drawing complete and accepted will be measured and paid at the unit price bid.

**EXHIBIT 5 – SPECIAL PROVISIONS**

Item No.	Description	Unit
8091000	RIGHT OF WAY MARKER (REINFORCED CONCRETE)	EA
8091010	RIGHT OF WAY MARKER (REBAR AND CAP)	EA
8091050	RIGHT OF WAY PLAT	LS

**(66) SECTION 810: SEEDING:**

The Contractor’s attention is called to the Environmental Commitments in **EXHIBIT 8** regarding invasive plant species. The Contractor shall comply with the intent of Presidential Executive Order on Invasive Species 13112, of February 3, 1999, by formulating a plan to actively re-plant native vegetation for all temporarily disturbed areas. The plan will include planting fast growing, locally native plant species to minimize the potential for establishment of aggressive, invasive species. The Contractor shall coordinate with the Environmental Management Office as well as the Refuge Manager while preparing the plan.

Section 810.2.2.3 is hereby amended by adding the following note to the table:

<sup>2</sup> The use of Annual Sudan Grass for temporary vegetation shall be prohibited statewide.

The first paragraph of Section 810.4.3 is amended to read as follows:

- 1 Before acceptance of the seeding performed for the establishment of permanent vegetation, the Contractor will be required to produce a satisfactory stand of perennial grass sufficient to control erosion. It will not be necessary for the grass to re-establish after dry periods or winter weather for acceptance and payment to be made.

**(67) SECTION 815: EROSION CONTROL MEASURES:**

In addition to the erosion control measures specified in the Plans, Standard Specifications, Supplemental Technical Specifications and the Special Provisions, the Contractor is advised that all land disturbing activities (clearing and grubbing, excavation, borrow and fill) are subject to the requirements set forth in the following permits and regulations:

- South Carolina Code of Regulations 63-380, Standard Plan for Erosion, Sediment, and Stormwater Runoff Control.
- Erosion and Sediment Reduction Act of 1983 (Title 48, Chapter 18 of the South Carolina Code of Laws of 1983, as amended). Section 70 of this code authorized the South Carolina Department of Health and Environmental Control (SCDHEC) to administer this regulation with respect to lands under the jurisdiction of the South Carolina Department of Transportation.
- National Pollutant Discharge Elimination System (NPDES) General Permit Number SCR160000, effective January 1, 2013: The Environmental Protection Agency, in accordance with the Federal Clean Water Act, has granted to the South Carolina Department of Health and Environmental Control (SCDHEC) the authority to administer the Federal NPDES permit program in the State of South Carolina.

In accordance with the NPDES General Permit, the Contractor must sign a Contractor Certification. The certification is incorporated into the proposal form for the Contract. By signing this form, the Contractor acknowledges that upon award and execution of the Contract, he/she accepts/ understands the terms and conditions of the *Storm Water Pollution Prevention Plan (SWPPP)* as required by the NPDES General Permit and may be legally accountable to SCDHEC for compliance with the terms and conditions of the *SWPPP*. In addition, the Contractor certifies that the NPDES certification statement status is made part of all its subcontracts.

## EXHIBIT 5 – SPECIAL PROVISIONS

The Contractor will complete and forward an updated SCDOT approved *Notice of Intent (NOI)* to the SCDOT Construction office to submit to SCDHEC. If the Coastal Zone Consistency (CZC) permit has not been approved it shall be forwarded by the Contractor to SCDOT to submit to SCDHEC as part of *NOI* package. If SCDHEC does not send a letter within 10 business days of receipt of the *NOI*, authorizing coverage, denying coverage, or advising that a review of the *CECP* will take place, coverage will be automatically granted.

Prepare and submit a *Contractor's Erosion Control Plan (CECP)* to the RCE before the pre-construction conference. Ensure that the plan meets the requirements of the NPDES General Permit. The plan will be reviewed and approved by the Department before commencing any land disturbing activities.

At the pre-construction conference, with contactors performing land-disturbing activities present, the *CECP* will be explained and discussed so that the Contractor is made aware of their responsibilities in the *CECP*.

Once approved, fully implement the *CECP*. Coordinate the prompt installation of erosion control devices with construction activities to maintain compliance with the above regulations and NPDES General Permit.

Conduct an Erosion and Sediment Control Inspection by an appointed Certified Erosion Prevention and Sediment Control Inspector (CEPSCI) from the Contractor and the Department at least every 7-calendar days. Both parties will acknowledge participation in the inspection by signing the inspection report and include their inspector's CEPSCI number on the report. Correct deficiencies noted during these inspections within the assigned priority period. If deficiencies are not corrected within this timeframe, the RCE will stop all work (except erosion and sediment control measures) until the deficiencies are corrected.

Give special attention to critical areas within the project limits (i.e., running streams, water bodies, wetlands, etc.). In these areas, the RCE may direct the Contractor to undertake immediate corrective action, but in no case allow these deficiencies to remain unresolved more than 7 days or 48 hours in accordance with their assigned priority after being identified during the Erosion and Sediment Control Inspection.

Closely follow the grading operations with the seeding operations. Shape and prepare the slopes for seeding as the grading progresses. Unless the RCE grants prior written approval, limit the amount of surface area exposed by land disturbing activities to 750,000 square feet. Commence seeding operations within 7 days following completion of construction activities within an area.

Initiate stabilization measures within 7 days for an area where construction activities will be temporarily or permanently ceased for 14 days or longer.

Coordinate the installation of all other permanent erosion control items with the grading and seeding operations. These items include, but are not limited to, asphalt gutter and riprap. Construct gutter work before or promptly after the seeding is performed. Place riprap at the ends of pipe immediately after the pipe is laid and promptly install riprap ditch checks after ditch work has been performed.

Failure to adequately comply with the provisions as detailed above or any other required erosion control measures will result in stoppage of all contract operations (except erosion and sediment control measures) until corrective action has been taken. Additional sanctions may be invoked by the SCDHEC in accordance with their authority.

Keep the following documents at the RCE's office from the start of construction until the site is finally stabilized:

- Copy of the *CECP*,

EXHIBIT 5 – SPECIAL PROVISIONS
--------------------------------

- Copies of Contractor Certification statements,
- Copy of the permit,
- Letter from DHEC authorizing permit coverage if provided by SCDHEC, and
- A marked-up set of site plans.

When uniform perennial vegetation achieves a cover density of 70%, submit a *Notice of Termination (NOT)* to SCDHEC to terminate coverage. Include a signed statement with the *NOT* certifying that all work on the site has been completed in accordance with the *SWPPP* and the NPDES General Permit for all sites one acre or greater.

Fines assessed on the Department by SCDHEC as the result of the Contractor's non-compliance or violation of said permit provisions will be paid by the Department and will subsequently be deducted from any monies due or that may become due to the Contractor. In case no monies are due or available, the fines incurred will be charged against the Contractor's Surety.

EXHIBIT 5 – SPECIAL PROVISIONS

Contractor Certification Form

Date: \_\_\_\_\_

A. Project Information

NPDES Coverage No.: SCR \_\_\_\_\_ State Permit (Tracking) No.:

Project/Site Name (As Approved by Department):

3. Owner/Operator Name: South Carolina Department of Transportation (SCDOT)

B. Contractor Information

1. Name: \_\_\_\_\_ Title/Position: \_\_\_\_\_

Mailing Address: \_\_\_\_\_ City: \_\_\_\_\_ State: \_\_\_\_\_ Zip: \_\_\_\_\_

Company Name (As Applicable):

Phone: \_\_\_\_\_ Email Address: \_\_\_\_\_

2. Describe Construction-Related Responsibilities & Activities (linear construction, facility construction)

C. Contractor Certification Statements & Agreement: (Read the Contractor Certification statements below (in entirety) and provide date and signature of agreement below). See Section 122.22 of S.C. Reg. 61-9 for signatory authority requirements. DO NOT SIGN IN BLACK INK!

"I certify by my signature below that I or I (on behalf of my company and its contractors and agents), as the case may be, Understand, accept, and will adhere to the provisions of the Stormwater Pollution Prevention Plan (SWPPP) as it pertains to the portion of the project I am or my company is responsible for, and as required by the coverage under the National Pollutant Discharge Elimination System (NPDES) General Permit for Stormwater Discharges From Construction Activities SCR160000 issued to SCDOT of the construction activity with whom I am or my company is under contract to perform construction related professional services; Am legally accountable to the SC Department of Health and Environmental Control (DHEC), under the authorities of the Clean Water Act and the SC Pollution Control Act, to ensure compliance with the terms and conditions of the SWPPP applicable to my or my company's portion of the project; Must comply with the terms and conditions of the SCDOT Construction General Permit (SCDOT CGP), will adhere to applicable standards and stormwater erosion control practices established in the SWPPP, the Best Management Practices (BMP) manual, and SCDOT Standard Specifications at all times while performing work at the project site, and agree to implement corrective actions identified by the qualified inspector during a site inspection; and Understand that DHEC enforcement actions may be taken against the permittee, the contractor or both if the terms and conditions of the SWPPP are not met.

Therefore, having understood the above information, I am signing this certification as contractor to the aforementioned NPDES general permit."

Printed Name of Contractor Title/Position

Signature of Contractor Date Signed

Termination of Contractor Certification Agreement: DO NOT SIGN IN BLACK INK! (When the permitted construction project has reached final acceptance by SCDOT, sign and date below)

Signature of Contractor Date Signed

DHEC 0437 (10/2012)

**(68) SAFETY FENCE:**

**Safety Fence**

**Description**

This work consists of furnishing materials, installing, and maintaining safety fence to mark all jurisdictional boundaries within a project corridor. Additionally where appropriate the Contractor should hang highly visible flagging to outline the jurisdictional boundaries. The fence and flagging shall be installed prior to any land disturbing activities.

**Materials**

Polyethylene or polypropylene fence shall be an orange preconstructed safety fence approved by the Engineer. The fence shall be furnished with an ultraviolet coating and protected against moisture and extended ultra-violet exposure prior to placement. Either wood or steel posts may be used. Install safety fence using wooden stakes (1 inch x 1 inch) or steel posts (1.25 lbs/ linear foot) a minimum of five (5) feet in length.

**Construction**

No additional clearing and grubbing is anticipated for the installation of the safety fence. The fence shall be erected along and around the existing ground contour and vegetation.

Place survey stakes with high visibility flagging on 25' feet maximum intervals along the jurisdictional boundary. With the boundary established, install the orange safety fencing parallel to and offset 10 feet from the outside perimeter of all jurisdictional boundaries. The safety fence may be installed on a tangent that runs parallel to the buffer but must not encroach on the buffer at any location. Post shall be set on a maximum of 10 feet spacing.

Wetland flagging tape should be placed on adjacent vegetation to assist contractors in recognizing the jurisdictional boundaries.

The Contractor shall maintain the safety fence in satisfactory condition for the duration of the project as determined by the RCE.

**(69) DIVISION 200: SETTLEMENT PLATES:**

1.1 Scope

The work under this Section consists of furnishing all supervision, labor, material, equipment, and related services necessary to furnish and install settlement plates as indicated on the Drawings and specified herein. The Contractor shall accommodate **the Department and** the Engineer in the monitoring of settlement plates.

The purpose of the settlement-monitoring program is to:

1. Confirm estimates of the time rate of settlement of embankments and retaining walls during construction so that construction methods may be adjusted, if necessary, to meet the project schedule;
2. Confirm that settlement is sufficiently completed prior to final grading and paving of roadways supported on embankments and retaining walls.

Consolidation settlement of the foundation soils is expected to occur during and for a period after construction of new embankments and retaining walls. The magnitude and rate of the settlement will depend on the variation of the stratigraphy and consolidation properties of the foundation soils. To effectively manage the post-construction settlement,

## EXHIBIT 5 – SPECIAL PROVISIONS

settlement plates shall be used to monitor the magnitude and rate of settlement during construction.

Settlement plates shall be furnished and installed by the Contractor in the presence of the Engineer. Settlement plates shall consist of a steel plate with coupling for attaching the central rod and protective PVC casing. A benchmark shall be established on stable ground that is not subject to settlement.

### 1.2 Responsibilities of Contractor:

The Contractor shall notify **the Department and** the Engineer at least five (5) working days prior to the installation of settlement plates.

The Contractor shall furnish and install the settlement plates in the presence of the Engineer.

The Contractor shall provide a licensed surveyor to stake out and provide as-built locations and elevations of all settlement plate locations and benchmarks.

The Contractor shall protect the settlement plates and benchmarks from damage for the duration of the Contract.

The Contractor shall provide **the Department and** the Engineer safe access to the settlement plates for the purpose of data collection for the duration of the Contract.

The Contractor shall be responsible for locating all settlement plates in the field and ensuring that no conflicts exist between settlement plates and existing and proposed structures, utilities or other construction proposed or present at the site.

### 1.3 Site Preparation

The Contractor shall ensure a firm base on which heavy equipment and/or other necessary equipment can be operated safely under its own power for installation of settlement plates.

The Contractor shall accurately locate all settlement plates in accordance with Drawings. Settlement plates may be adjusted by the Contractor, with the approval of the Engineer, to avoid utilities, foundations, and all other underground construction.

### 1.4 Existing Soil Conditions:

The subsurface conditions encountered at the site are presented in the Contract Plans and documents.

## 2.0 PRODUCTS

### 2.1 Settlement Plate

The settlement plate shall consist of a 30-in. square, 1/2-in. thick steel plate with a coupling centered on the plate for attaching a central steel rod. In addition, the plate shall have a means for keeping the protective PVC casing centered on the steel rod.

### 2.2 Central Steel Rod

A central steel rod shall extend from the plate vertically to allow for measurements of the elevation of the settlement plate. The rod shall be of sufficient diameter to prevent buckling or swaying over the height of the fill. In addition, the rod will either be threaded at both ends or will be threaded rod to allow for the addition of extensions. The central steel rod



## EXHIBIT 5 – SPECIAL PROVISIONS

will include the necessary couplers to allow for the extension. Metal pipe may be substituted for the rod, provided the pipe is manufactured from similar material as the settlement plate.

### 2.3 Protective PVC Casing

A schedule 40 PVC pipe shall be installed around the central steel rod to protect the rod from compaction operations. The PVC casing will have an inside diameter of no less than 3 inches. The casing may have either glued or threaded joints. The joints should form a watertight seal. A protective cap shall be placed at the top of the PVC casing to prevent soil, water and other debris from being introduced into the casing. In addition, the casing shall extend a minimum of 1 foot and no more than 5 feet above the ground surface at the base of casing during fill placement. Further, the contractor shall visibly identify the location of the PVC casing to prevent damage to the casing during the placement of fill materials.

### 2.4 Incidentals

Incidental hardware, fasteners, tools, and the like, as necessary to install the system in accordance with these specifications, shall be provided.

### 3.0 SUBMITTALS

The Contractor shall submit a plan for the settlement plates indicating where the coupling and protective casing supports are to be located and the method to be used to attach the coupling and casing supports.

Within 1 week following installation, the contractor shall submit an installation record for each settlement plate, which includes the plate designation, station, offset, and elevation of the Settlement plate. The settlement plate shall be located to an accuracy of 0.01 ft (both vertically and horizontally).

### 4.0 EXECUTION

#### 4.1 Settlement Plate Installation

The Contractor shall furnish and install settlement plates in accordance with the Drawings and these specifications and in the presence of **the Department and** the Engineer. Settlement plates shall be installed prior to embankment or retaining wall construction and following installation of wick drains, stone columns, or other ground improvement, and grubbing and clearing in the immediate vicinity of each settlement plate. The Contractor, only with the approval of **the Department and** the Engineer, may adjust settlement plate locations. The settlement plates shall be placed on a firm, level area as indicated in the plans.

#### 4.2 Allowance for Settlement Plate Monitoring

The Contractor shall accommodate **the Department and** the Engineer during construction to provide safe and timely access to settlement plates for the purpose of obtaining measurements, as construction progresses. The Contractor shall retain a licensed land surveyor to monitor the settlement of the plates. Evaluation of the settlement plate data will be the responsibility of the Engineer.

#### 4.3 Fill Height Survey

The Contractor shall make a survey of the central rods daily while fill is being placed, and twice weekly after completion of fill placement, unless directed otherwise by the Engineer

**EXHIBIT 5 – SPECIAL PROVISIONS**

and the Department. Additionally, surveys shall be made at the addition of an extension rod. The measurements shall be obtained both before and after the addition of the extension rod. Surveys made by the Contractor shall be provided to the Engineer within one week. In addition, the Contractor shall provide all readings as the elevation of the plate to the nearest 0.01 ft. Further the Contractor will provide the temperature in degrees Fahrenheit (°F) and the time (actual) of obtaining the settlement plate elevations. Processed settlement plate data shall be made available by the Engineer to the Department at any time.

**4.4 Protection of Settlement Plates**

The Contractor shall protect settlement plates from damage and vandalism for the duration of the Contract and repair or replace damaged or inoperative settlement plates at no cost to the Department.

**4.5 Abandonment of Settlement Plates**

Once the Department and the Engineer have determined that the settlement plates have served their purpose and are no longer needed, they shall be abandoned in-place. The Contractor shall remove as much of the central steel rod as can be recovered and shall cut the PVC casing off two feet beneath the finished subgrade. The Contractor shall fill the PVC casings remaining in the ground with lean grout and shall place two feet of properly compacted fill on top of the testing location.

**5.0 METHOD OF MEASUREMENT**

The number of settlement plates, as provided in the plans, will be paid for at the contract unit price bid for "Monitoring Device - Settlement Plates" which shall include all equipment, including but not limited to the settlement plates; mobilization; labor; surveys; materials; incidentals and abandonment required by these Specifications.

**6.0 BASIS OF PAYMENT**

The price and payment for this work shall be full compensation for furnishing the necessary Settlement Plates, including the settlement plates, surveys and incidental items based on the acceptance of the Settlement Plate installation by the Engineer.

**Payments shall be made under:**

<b>Item No.</b>	<b>Pay Item</b>	<b>Pay Unit</b>
2038110	MON. DEVICE – SETTLEMENT PLATE	EA

EXHIBIT 5 - SPECIAL PROVISIONS

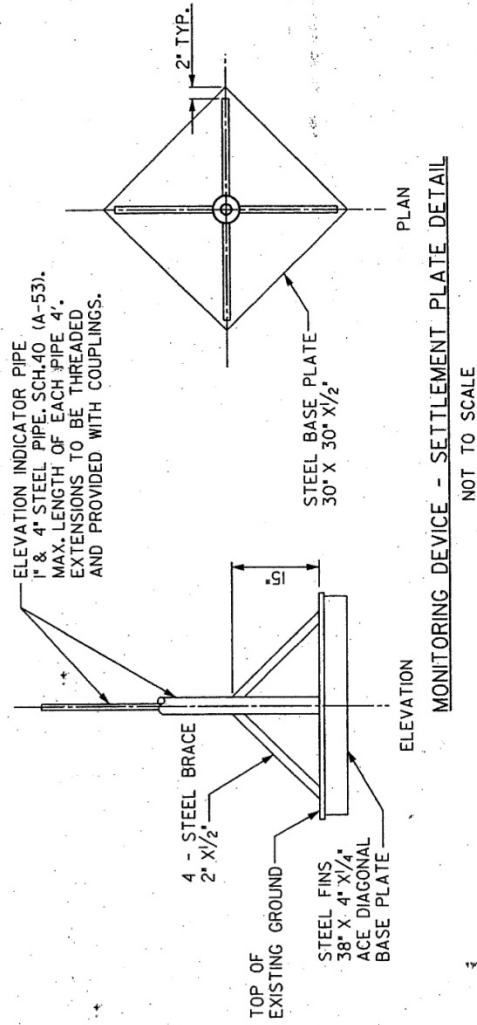

**(70) NONWOVEN GEOTEXTILE INTERLAYER FABRIC FOR CONCRETE PAVEMENT:**

This Special Provision describes the construction and material requirements for installation of an interlayer fabric to be used between concrete pavement and cement stabilized aggregate base.

**REFERENCED DOCUMENTS**

**ASTM D 4355** *Standard Test Method for Deterioration of Geotextiles by Exposure to Light, Moisture and Heat in a Xenon Arc Type Apparatus*

**ASTM D 4491** *Standard Test Methods for Water Permeability of Geotextiles by Permittivity.*

**ASTM D 4595** *Standard Test Method for Tensile Properties of Geotextiles by the Wide-Width Strip Method.*

**ASTM D 4716** *Standard Test Method for Determining the (In-plane) Flow Rate per Unit Width and Hydraulic Transmissivity of a Geosynthetic Using a Constant Head.*

**ASTM D 5199** *Standard Test Method for Measuring the Nominal Thickness of Geosynthetics.*

**ASTM D 5261** *Standard Test Method for Measuring Mass per Unit Area of Geotextiles.*

**1. GENERAL**

1.1. Provide and install a non-woven geotextile interlayer to be placed between concrete pavements and cement stabilized aggregate bases. The fabric is intended to provide limited drainage, separation between the base and pavement to retard the transmission of cracking, and relief of bedding stress due to movement of the concrete pavement on a stiff base. Attach the fabric firmly to the base to prevent movement during paving operations. Conduct paving operations to minimize fabric damage due to vehicle movements. Repair any damage prior to paving to ensure complete coverage of the base.

**2. MATERIAL REQUIREMENTS**

2.1. Geotextile requirements:

2.1.1. Fabric type: Provide a nonwoven needle-punched geotextile. Thermal treatment (calendering or IR) is not acceptable.

2.1.2. Color: Ensure that the color is uniform and uses nominally the same color fibers throughout.

2.1.3. The following requirements must be met by 95% of samples. Minimum Average Roll Values (MARV) are also acceptable:

2.1.3.1. Mass per unit area: Ensure that mass per unit area is greater than 450 grams per square meter (13.3 ounces per square yard) and less than or equal to 550 grams per square meter (16.2 ounces per square yard) when tested in accordance with ASTM D 5261.

## EXHIBIT 5 - SPECIAL PROVISIONS

- 2.1.3.2. Thickness under load (pressure): Ensure that the thickness under load is greater than or equal to 3.0 mm at 2 kPa (0.12 inch at 0.29 psi), greater than 2.5 mm at 20 kPa (0.10 inch at 2.9 psi), and greater than 1.0 mm at 200 kPa (0.04 inch at 29 psi) when tested in accordance with ASTM D 5199.
- 2.1.3.3. Wide-width tensile strength: Ensure the tensile strength is greater than 10 kN per meter (685 pounds per foot) when tested in accordance with ASTM D 4595.
- 2.1.3.4. Maximum elongation: Ensure that the maximum elongation is less than or equal to 60 percent when tested in accordance with ASTM D 4595.
- 2.1.3.5. Water permeability in normal direction under load (pressure): Ensure that the water permeability in the normal direction under load (pressure) is greater than or equal to  $1 \times 10^{-4}$  meters per second ( $3.3 \times 10^{-4}$  feet per second) when tested in accordance with modified ASTM D 4491 at 20 kPa (2.9 psi).
- 2.1.3.6. In-plane water permeability: Ensure that the in-plane water permeability (transmissivity) under load (pressure) is greater than or equal to  $5 \times 10^{-4}$  meters per second ( $1.6 \times 10^{-3}$  feet per second) when tested in accordance with modified ASTM D 4716 at 20 kPa (2.9 psi) and is greater than or equal to  $2 \times 10^{-4}$  meters per second ( $6.6 \times 10^{-4}$  feet per second) when tested in accordance with modified ASTM D 4716 at 200 kPa (29 psi)..
- 2.1.3.7. Weather resistance: Ensure that the retained strength after 500 hours of weathering is greater than or equal to 60 percent of the initial strength when tested in accordance with ASTM D 4355.
- 2.1.3.8. Alkali resistance: Provide a manufacturer certification that the supplied material is composed of 96% or more polypropylene/polyethylene.
- 2.1.4. Certification: Prior to incorporation in the work, provide the **RCE** with a manufacturer's certification stating that the material being used meets all requirements of this Special Provision for each batch or lot of material. Ensure that the provided certification references the batch number(s) supplied and is attested to by the notarized signature of an officer of the manufacturing company. Also provide the RCE with a copy of the manufacturer's independent test data showing results for all the properties given in this section obtained by the test methods provided. Test data does not have to be batch or lot-specific.
- 2.2. Anchor system requirements:
- 2.2.1. Fasteners: Use hardened steel pin fasteners with a galvanized finish intended for insertion in concrete by a powered fastening tool. Select a diameter and length adequate to anchor the geotextile such that normal paving operations do not dislodge the pins and the base is not damaged by the insertion.
- 2.2.2. Discs: Provide thin, galvanized steel discs ranging from 2.0 to 2.8 inches in diameter with small stamped claws for holding the fabric and distributing the anchoring load.

### 3. CONSTRUCTION

## EXHIBIT 5 - SPECIAL PROVISIONS

- 3.1. Preparation of base: Repair any damaged or defective areas in the base to the satisfaction of the **RCE**. Thoroughly sweep the base immediately prior to fabric placement and ensure that the surface is free of loose debris.
- 3.2. Timing of placement: Place fabric no more than 3 days ahead of paving operations. If concrete is being placed by trucks directly in front of the paver, do not place fabric more than 650 feet ahead of the paver.
- 3.3. Placement: Roll the material onto the base, keeping the fabric tight with no wrinkles or folds. Roll out the sections of the fabric in a sequence that will facilitate good overlapping, prevent folding or tearing by construction traffic, and minimize the potential that the material will be disturbed by the paver. Overlap sections of the fabric a minimum of 6 inches and a maximum of 10 inches. Ensure that no more than three layers overlap at any point. Extend the fabric a minimum of 12 inches beyond the edge of the concrete pavement.
- 3.4. Anchoring: Secure the fabric with fasteners punched through the steel discs into the base. Space the anchors as necessary to securely hold the fabric in position during paving operations. However, maintain a maximum anchor spacing of 6 feet under all circumstances.
- 3.5. Construction traffic: Keep all nonessential traffic off of the fabric. Ensure that operations are staged such that no vehicles make sharp turning motions on the fabric. Remove and replace damaged fabric using required placement overlaps and sufficient anchors.
- 3.6. Moisture: Lightly but completely dampen the fabric ahead of the paving operations to ensure that the fabric does not draw water from the concrete. If the fabric is wetted due to precipitation or other reasons to the point of standing water or that free water appears when the fabric is walked on, allow the fabric to dry to a moist condition before continuing paving operations.

### (71) DIVISION 200: GROUND MODIFICATION – COMPACTION GROUTING COLUMNS

August 1, 2005

#### 2.0 GENERAL

##### 2.1 Scope:

The work under this Section consists of furnishing all supervision, labor, material, equipment, and related services necessary to perform ground improvement by the compaction grout technique as indicated on the Contract Drawings and specified herein.

For this project, the purpose of the compaction grouting is to reinforce the loose sand layers below embankments. The compaction grouting will serve to reinforce loose sand in the event of liquefaction during an earthquake.

The work includes the delivery and placement of all concrete/grout material necessary for compaction grouting construction.

##### 2.2 *Compaction Grout Column Construction*

The work is to be accomplished using specifically-designed equipment for compaction grouting. The drill is to be advanced to the specified compaction grouting depth.

Concrete/grout shall then be injected through the drill pipe as the pipe is being withdrawn, in such a way as to exert a positive lateral pressure on the soil surrounding the concrete/grout filled grout hole.

**2.3 Methods and Contractor Qualifications:**

The Specialty Contractor performing the compaction grouting installation shall be one who can provide a minimum 3-year experience record documenting 5 recent, successful projects completed with these general site conditions and improvement criteria. References asserting this documentation shall be submitted with the bid.

A detailed description of the proposed construction method (including equipment and personnel) and the qualifications of the proposed Specialty Subcontractor shall be submitted with the bid.

**2.4 References:**

American Society for Testing and Materials (ASTM) Standards.

American Concrete Institute (ACI) Standards.

Prior to commencing work, the Contractor shall examine the site, drawings, records or existing utilities and other existing subsurface structures, and soil boring logs made available by the Engineer to help determine compaction grouting installation conditions.

Any subsurface data provided by the Department are provided solely as general information for convenience of Contractor. It is expressly understood that the Department, Engineer, or the Engineer's consultants will not be responsible for interpretations or conclusions drawn there from by the Contractor. The Department and Engineer expressly encourage the Contractor to perform soil test borings or other subsurface explorations to determine whether the Contractor's proposed ground modification method is capable of installing the specified compaction grout columns. Additional test borings and other exploratory operations may be made by the Contractor at no additional cost to the Department.

**2.5 Submittals:**

The following data shall be submitted for the approval of the Engineer and the Department prior to beginning of work.

- a. A detailed written procedure to be followed in installing the compaction grout columns and confirming that the specified work requirements have been achieved. The written procedure shall include a detailed description of the specialized equipment to be used.
- b. Proposed compaction grout design mix and descriptions of materials to be used. These shall be in sufficient detail to indicate their compliance with the specifications and either 1.) Laboratory tests of trial mixes made with the proposed mix or 2.) Laboratory tests of the proposed mix used on previous projects.
- c. The Contractor shall be responsible for providing all lines and grades for compaction grouting, including locations of all utilities and surveying markers.
- d. The Contractor shall be responsible for all health and safety requirements including those associated with the handling and disposal of contaminated

## EXHIBIT 5 - SPECIAL PROVISIONS

materials. The Contractor shall be responsible for providing written procedures including a Health and Safety Plan.

### 2.6 *Site Preparation:*

The Contractor shall ensure a firm base on which heavy equipment can be operated safely under its own power.

The Contractor shall accurately locate all compaction grout columns in accordance with approved drawings. Compaction grouting shall be adjusted, as approved by the Engineer, to avoid utilities, foundations, and all other underground construction.

The Contractor shall provide access and maintenance thereof, for the compaction grouting equipment, work force and delivery of materials to the work site.

## 3.0 PRODUCTS

### 3.1 *Materials:*

2.1.1 Portland Cement: Portland Cement shall conform to current ASTM standards, designation C 150. The use of cement replacement materials will be permitted subject to the approval of the Engineer and provided that they can be shown to have beneficial effects on concrete impermeability, heat generation during setting and general durability. The mix proportions of use shall be approved. For onsite batching, all cement and cement replacement materials shall be stored in separate containers according to type in waterproof stores or silos.

2.1.2 Mineral Admixture: Mineral admixture, if used, shall be flyash or natural pozzolan which possesses the property of combining with the lime liberated during the process of hydration of Portland Cement to form compounds containing cementitious properties. The material shall conform to ASTM C 618, Class C or Class F.

2.1.3 Fluidifier: Fluidifier shall be a compound possessing characteristics which will increase the fluidity of the mixture, act as water reducing agent and retardant.

2.1.4 Water: Water shall be potable, fresh, clean and free of sewage, oil, acid, alkali, salts or organic matter.

2.1.5 Fine Aggregate: Sand shall meet the requirements of current ASTM standards, designation C 33.

### 2.2 *Grout Mixes:*

The concrete/grout mix shall consist of Portland cement, sand, and water, and may also contain a mineral admixture and approved fluidifier. The components shall be proportioned and mixed to produce a concrete capable of maintaining the solids in suspension, which may be pumped without difficulty. These materials shall be proportioned to produce a hardened concrete/grout which will achieve the design strength within 28 days. The design 28-day concrete strength for this project shall be 2500 psi.

All materials shall be accurately measured by volume or weight as they are fed to the mixer. Time of mixing shall be not less than one minute at the site. If agitated continuously, the concrete/grout may be held in the mixer or agitator for a period not exceeding two and one half hours at concrete temperatures below 70 degrees F and for



## EXHIBIT 5 - SPECIAL PROVISIONS

a period not exceeding two hours at higher temperatures, not exceeding 100 degrees F. Concrete/grout shall not be placed when its temperature exceeds 100 degrees F.

Protect concrete/grout from physical damage or reduced strength which could be caused by frost, freezing actions or low temperatures or from damage during high temperatures in accordance with ACI 305/306.

The concrete/grout mix shall be tested by making a minimum of six 2-inch cubes for each day during which compaction grouting is performed. A set of six cubes shall consist of two cubes to be tested at seven days, and two cubes to be tested at 28 days and two cubes held in reserve. Test cubes shall be cured and tested in accordance with ASTM C 109. Test the flow of each batch of concrete mix.

### **2.3 Concrete/Grout Testing:**

2.3.1. Sampling: Concrete/grout for the columns shall be sampled in accordance with ACI standards.

2.3.2. Workability: The workability of concrete/grout shall be determined by the slump test as described in ACI standards or by an alternative approved method.

2.3.3. Cube Tests: For each mix design of concrete, six cubes shall be made from a single batch when required for 65 cy of concrete/grout or part thereof in each day's work. Testing shall be carried out by an independent and approved laboratory. Two cubes shall be tested at an age of 7 days, two at 28 days, and two cubes shall be held in reserve for further testing, if required. Alternatively, cubes may be tested in accordance with an approved accelerated testing regime. The Contractor shall submit certified copies of the results of all tests to the Engineer.

2.3.4. Standard of Acceptance: The standard of acceptance of the concrete mix cubes shall be in accordance with ACI standards or as otherwise approved.

2.3.5. Record of Tests: The Contractor shall keep a detailed record of the results of all tests on concrete/grout and concrete materials. Each test shall be clearly identified with the columns to which it relates.

### **2.4 Batching Concrete/Grout:**

2.4.1. General: Facilities shall be provided for the Engineer to inspect the concrete/grout mixing plant or plants when requested. Unless otherwise specified the requirements in Clauses 2.5.2, 2.5.3, 2.5.4 shall be met.

2.4.2. Accuracy of Weighing and Measuring Equipment: The weighing and water-dispensing mechanisms shall be maintained at all times to within the limits of accuracy described in ACI standards.

2.4.3. Tolerance in Weights: The weights of the quantities of each size of aggregate and of cement shall be within 2% of the respective weights per batch after due allowance has been made for the presence of free water in the aggregates, which shall be determined by the Contractor by an approved method.

2.4.4. Moisture Content of Aggregates: The moisture content of aggregates shall be measured immediately before mixing and as frequently thereafter as is necessary to maintain consistency of mix.

**2.5 Mixing Concrete/Grout**

- 2.5.1 Type of Mixer: The mixer shall be of the batch type, specifically designed for concrete/grout mixing.
- 2.5.2 Tolerance of Mixer Blades: The mixing blades of pan mixers shall be maintained within the tolerances specified by the manufacturers of the mixers, and the blades shall be replaced when it is no longer possible to maintain the tolerances by adjustment.
- 2.5.3 Cleaning of Mixers: Mixers which have been out of use for more than 30 minutes shall be thoroughly cleaned between the mixing of different types of cement.
- 2.5.4 Minimum Temperature: The temperature of fresh concrete/grout shall not be allowed to fall below 37° F. No frozen material or materials containing ice shall be used. Newly cast columns are to be covered to protect them against freezing unless the final cut off level is at least 0.8 ft. below the final head level as cast. Where a column is cast in frozen ground, appropriate precautions shall be taken to protect any section of the column in contact with the frozen soil where this occurs below the cut off level.

**2.6 Transporting Concrete/Grout**

- 2.6.1. Method of Transporting: The method of transporting concrete/grout shall be submitted for approval. Concrete/grout shall be transported in uncontaminated watertight containers in such a manner that loss of material and segregation are prevented.
- 2.6.2. Pumping Concrete/Grout: Pumped concrete/grout complying with this Specification may be used. The methods employed in its use shall be subject to approval.

**2.7 Ready-mixed Concrete/Grout**

- 2.7.1. Conditions of Use: Subject to approval, the Contractor may use ready-mixed concrete/grout in accordance with ACI standards. Approval shall be obtained for each proposed use of ready-mixed concrete/grout in different sections of the Works and for each different mix, which shall comply with this Specification.
- 2.7.2. Mixing Plant: Unless otherwise agreed by the Engineer, truck mixer units and their mixing and discharge performance shall comply with the requirements of ACI standards.

**3.0 EXECUTION****3.1 General**

The Compaction grout column technology employs a drill stem for both penetration and maintaining borehole stability. The concrete/grout is pumped into the column from the base of the drill stem. All materials and work shall be in accordance with Sections 1, 2 and 3 of this Specification.

**3.2 Layout**

The procedure for layout of columns and checking their positions shall be approved by the Engineer. The actual compaction grout columns shall be installed within 3 inches of

## EXHIBIT 5 - SPECIAL PROVISIONS

the design location shown on the Drawings, approved shop drawings or as otherwise directed by the Engineer.

### 3.3 **Diameter of Columns**

The diameter of a column shall be not less than 24-in.

### 3.4 **Equipment**

The Contractor shall use a drill rig capable of penetrating all necessary soil layers or obstructions.

### 3.5 **Penetration**

3.5.1. Penetration Near Recently Cast Columns: Columns shall not be advanced so close to other columns which have recently been cast and which contain workable or unset concrete/grout that a flow of concrete could be induced from or damage caused to any of the columns. A minimum distance of 8 ft (center-to-center) shall be kept between columns less than 24-hours old and on-going column installations.

3.5.2. Removal of Drill Pipe from the Ground: Drill Pipe shall not be extracted from the ground during the penetration or construction of a column in such a way that an open unsupported void or inflow of water into the column section would result.

3.5.3. Depth of Columns: Any failure of a column to reach the required depth, as given in the Specification or shown on the Drawings, shall be reported to the Engineer without delay and a full statement of the reasons given. **The Engineer shall provide a recommendation to the Department.**

### 3.6 **Placing of Concrete/Grout**

3.6.1. Mix Design and Workability: Where not otherwise stated in this Section, the concrete shall comply with Section 2 of this Specification. The design and workability of concrete to be used in the formation of a column shall produce a mix which is suitable for pumping. It shall have a target slump of 4 to 6 inches unless otherwise approved and a minimum cement content of 580 lbs/yd<sup>3</sup>. The fine aggregate shall be in accordance with ACI standards. This mix shall be designed so that segregation does not occur during the placing process, and bleeding of the mix shall be minimized.

3.6.2. Equipment for Supply of Concrete/Grout to Columns: Concrete/Grout shall be supplied to the column through suitable tubing and hoses.

3.6.3. Commencement of Concrete/Grout Supply to Each Column: The technique and equipment used to initiate and maintain the concrete flow shall be such that a column of the full specified cross-section is obtained from the maximum depth to the final cut off level.

3.6.4. Rate of Supply of Concrete/Grout: The concrete/grout shall be supplied to the column at a sufficient rate during drill pipe withdrawal to ensure that a continuous monolithic shaft of the full specified cross-section is formed, free from debris or any segregated concrete/grout. The rate of withdrawal of the drill pipe and pressures of concrete/grout shall be measured and recorded throughout the phase of vibrator withdrawal for each column. The Contractor shall submit

## EXHIBIT 5 - SPECIAL PROVISIONS

proposals for his method of monitoring construction for approval prior to the commencement of the Works.

- 3.6.5. Completion of Columns: If the concrete/grout placing in any column cannot be completed in the normal manner, then the column shall be repenetrated before concrete/grout has hardened and shall be completely replaced.
- 3.6.6. Casting Level of Column Head: Concrete shall be cast to the commencing surface level or slightly above unless otherwise specified.
- 3.6.7. Disposal of Contaminated Material: The Contractor is responsible for disposal of all excavated soil, excess water, and spoil generated during installation of the compaction grouting installation at no extra cost. Manifests necessary for waste disposal shall be executed by the Engineer and coordinated with the Department.

### 3.7 Cutting of Column Heads

When cutting off and trimming columns to the specified cut off level, the Contractor shall take care to avoid shattering or otherwise damaging the rest of the column. Any latence, or contaminated, cracked or defective concrete/grout shall be cut away and the column made good in an approved manner to provide a full and sound section up to the cut off level.

### 3.8 Documentation:

Any proposed change in the approved construction program, necessitated by a change in the subsurface conditions, shall be submitted in writing to the Engineer for approval. The Engineer shall provide a recommendation to the Department.

A daily log shall be submitted to the Engineer and the Department by the Contractor to include hole number, start/finish time of treatment, depth of treatment, diameter of drill hole, description of soil penetrated, and volume of grout//concrete placed at depth in no more than 2-ft increments.

## 4.0 CONSTRUCTION

The compaction grout columns shall be constructed prior to bridge foundations. Positive site drainage shall be established prior to construction of compaction grouting. Contractor shall control all spoils generated during compaction grouting and prevent spoils from flowing offsite. Spoils generated by compaction grouting shall be disposed of properly and removed from the site by the Contractor. No additional compensation shall be made for handling spoil.

Compaction grouting columns shall be constructed to the lines and elevation shown on the plans, and in accordance with the Special Provisions.

Compaction grout columns shall extend from the existing ground surface to the elevations outlined in the plans. No payment will be made for compaction grout columns installed within areas that are later excavated. The Contractor shall be responsible to construct compaction grout columns to the depths required, and shall use the methods necessary to penetrate to the required depth, including but not limited to drilling through stiff and dense layers that may be present, as well as obstructions from existing construction.

The compaction grout columns shall be installed to the minimum required Area Replacement Ratio. The required minimum area replacement ratio ( $A_r$ ) achieved at any

**EXHIBIT 5 - SPECIAL PROVISIONS**

depth by the compaction grouting shall be that which is equivalent to the diameter of the grout columns at the center-to-center (c-c) spacing shown in the plans and on a triangular pattern. The area replacement ratio shall be defined by the following relationships:

$$A_r = \frac{\text{Column Area} \times 100\%}{\text{Tributary Area}}$$

Where: Column Area = Area of circle based on column diameter as defined below.  
Tributary Area =  $0.866 (\text{Column Spacing})^2$  for triangular spacing.

Acceptance of the constructed column will be based on the theoretical column diameter determined from the volume of concrete/grout installed.

The Contractor shall, at all times, protect structures, underground utilities and other construction from damage caused by grouting operations. Damaged material shall be replaced or repaired to the satisfaction of the Engineer and the Department at no additional cost to the Department.

**5.0 METHOD OF MEASUREMENT**

The bid item for compaction grouting shall include the delivery and placement of all concrete material necessary for compaction grout column construction. It shall also include disposal of all spoil (surface water, soil, etc.) in a manner acceptable to the Department of Health and Environmental Control, and to the Engineer, and to the Department.

**6.0 BASIS OF PAYMENT**

The quantity of ground modification measured for payments shall be the actual length of the installed compaction grout columns acceptable to the Engineer and to the Department. No payment will be made for ground modification beyond the limits required by the Contract Documents, unless such increases in the specified area are directed in writing by the Engineer.

The accepted quantity, measured as above, will be paid for at the contract unit price per linear foot for compaction grout columns constructed at the diameter specified in the plans, which price and payment shall be full compensation for furnishing, hauling, treating, compacting of materials, removal of spoils and for all labor, equipment, tools, maintenance, and incidentals necessary to complete this item of work.

Payment will be made under:

Item No.	Pay Item	Pay Unit
8990353	Ground modification – Compaction Grouting Columns	Linear ft

EXHIBIT 5 - SPECIAL PROVISIONS

**(72) DIVISION 200: GEOTEXTILES FOR SEPARATION AND STABILIZATION**

December 23, 2009

**1.0 DESCRIPTION**

This work is furnishing and installing geotextiles.

**2.0 MATERIALS**

A geotextile is defined as any permeable polymeric textile used with foundation, soil, rock, earth, or any other geotechnical engineering related material, as an integral part of a civil engineering project, structure, or system. Use geotextiles and thread used in joining geotextiles manufactured from fibers consisting of long-chain polymers, composed of at least 95 percent by weight of polyolefins or polyesters. Use geotextiles with fibers formed into a stable network such that the fibers or yarns retain their dimensional stability relative to each other, including selvages (edges) during shipping, handling, placement, and in service. Use geotextile free from defects or tears.

- A. **Minimum Average Roll Values.** All property values, with the exception of Apparent Opening Size (AOS), represent Minimum Average Roll Values (MARV) in the weakest principal direction. Provide geotextiles whose average test results from any roll sampled in a lot for conformance or quality assurance testing meets or exceeds minimum values provided in this Section.
- B. **Apparent Opening Size.** Values for Apparent Opening Size (AOS) represent maximum average roll values. Acceptance will be based on ASTM D 4759.
- C. **Separation Geotextile.** Use separation geotextile for unsaturated firm subgrade conditions.
- D. **Stabilization Geotextile.** Use stabilization geotextile for soft, wet, saturated subgrade conditions.

Furnish geotextiles meeting the strength property requirements of Table 1 and the AOS, permittivity, and ultraviolet stability requirements of Table 2 for separation geotextile, Table 3 for stabilization geotextile. The geotextile properties required for each class of survivability are dependent upon geotextile type, i.e. woven or nonwoven. When sewn seams are used, the strength of the sewn seams must be equal to or greater than 90 percent of the specified grab tensile strength.

**TABLE 1 - GEOTEXTILE STRENGTH PROPERTY REQUIREMENTS**

			GEOTEXTILE SURVIVABILITY <sup>1</sup>			
			Moderate Survivability (CBR ≥ 3; c <sub>u</sub> ≥ 1,800 psf)		High Survivability (CBR < 3; c <sub>u</sub> < 1,800 psf)	
PROPERTY	TEST METHODS	UNITS	Woven	Nonwoven	Woven	Nonwoven
Grab Elongation	ASTM D 4632	%	< 50	≥ 50	< 50	≥ 50
Grab Strength	ASTM D 4632	lbs.	250	160	315	200
Sewn Seam Strength <sup>2</sup>	ASTM D 4632	lbs.	225	145	285	180
Tear Strength	ASTM D 4533	lbs.	90	55	110	80
Puncture Strength	ASTM D 4833	lbs.	90	55	110	80
Apparent Opening Size	ASTM D 4751	Sieve Size	Required property values for AOS, permittivity, and UV stability are based on the geotextile applications. Refer to Table 2 for separation geotextile, Table 3 for stabilization geotextile.			
Permittivity	ASTM D 4491	sec. <sup>-1</sup>				
Ultraviolet Stability (retained strength)	ASTM D 4355	%				

**EXHIBIT 5 - SPECIAL PROVISIONS**

Notes:

1. All numeric values represent Minimum Average Roll Value (MARV) in the weaker principal direction.
2. When sewn seams are required. Refer to Section 3, Table 4 for overlap requirements.

**2.1 Separation Geotextile.** Provide geotextile meeting the strength requirements from Table 1 for the level of survivability specified on the plans or in the special provisions. Provide geotextile meeting the permittivity, apparent opening size, and ultraviolet stability requirements of Table 2.

**TABLE 2 - SEPARATION GEOTEXTILE PROPERTY REQUIREMENTS**

	<b>TEST METHODS</b>	<b>UNITS</b>	<b>REQUIREMENTS</b>
Geotextile Survivability	As specified from Table 1		
Permittivity <sup>1</sup>	ASTM D 4491	sec. <sup>-1</sup>	≥ 0.02
Apparent Opening Size	ASTM D 4751	Sieve Size (mm)	#30 (≤ 0.60)
Ultraviolet Stability (Retained Strength)	ASTM D 4355	%	≥ 50 after 500 hrs. of exposure

Notes:

1. Minimum value. Permittivity of the geotextile must be greater than that required for the soil. Use greater value as specified on the plans or in the special provisions.

**2.2 Stabilization Geotextile.** Do not use woven slit film geotextiles (i.e. geotextiles made from yarns of a flat, tape-like character). Provide geotextile meeting the strength requirements for high survivability from Table 1. Provide geotextile meeting the permittivity, apparent opening size, and ultraviolet stability requirements of Table 3.

**TABLE 3 - STABILIZATION GEOTEXTILE PROPERTY REQUIREMENTS<sup>1</sup>**

	<b>TEST METHODS</b>	<b>UNITS</b>	<b>REQUIREMENTS</b>
Geotextile Survivability	High Survivability from Table 1		
Permittivity <sup>2</sup>	ASTM D 4491	sec. <sup>-1</sup>	≥ 0.10
Apparent Opening Size	ASTM D 4751	Sieve Size (mm)	#40 (≤ 0.43)
Ultraviolet Stability (Retained Strength)	ASTM D 4355	%	≥ 50 after 500 hrs. of exposure

Notes:

1. Do not use woven slit film geotextiles.
2. Minimum value. Permittivity of the geotextile must be greater than that required for the soil. Use greater value as specified on the plans or in the special provisions.

**2.3 Source Approval.** Submit the following information regarding each geotextile proposed for use:

- Manufacturer's name and current address;
- Full product name/number;
- Geosynthetic material and structure; and
- Proposed geotextile use(s).

Submit a sample to the RCE for evaluation. Product acceptance is determined by comparing the average test results of all specimens within a given sample to the Minimum Average Roll Values (MARV) listed in Table 1.

## EXHIBIT 5 - SPECIAL PROVISIONS

Install geotextiles only after the material has been tested and accepted. Replace all geotextiles installed prior to acceptance that do not meet specifications at Contractor's expense.

**2.4 Sampling.** Cut a sample from the geotextile roll with the minimum dimensions of 4 feet by the full width of the roll beyond the first wrap. After the sample and the required information have been submitted to the RCE, allow 30 calendar days for evaluation.

**2.5 Identification, Shipment and Storage.** Conform to ASTM D 4873, *Standard Guide for Identification, Storage, and Handling of Geotextiles*. Clearly label each roll of geotextile shipped to the project with the name and address of the manufacturer, full product name/number, quantity, and roll number. Submit a manufacturer's certificate of compliance signed by an authorized manufacturer's official. The certificate must attest that the geotextile meets all the Minimum Average Roll Value (MARV) requirements specified in Table 1 as evaluated under the manufacturer's quality control program.

The RCE will reject materials that are mislabeled or misrepresented. Wrap each roll with a material that protects the geotextile, including ends of the roll, from damage due to shipment, water, sunlight, and contaminants. Maintain the protective wrapping during periods of shipment and storage. Do not damage the geotextile or wrapping when unloading or transferring from one location to another. Do not drag the rolls.

During storage, elevate geotextile rolls off the ground and adequately cover to protect them from the following:

- Site construction damage;
- Precipitation;
- Ultraviolet radiation including sunlight;
- Chemicals that are strong acids or strong bases;
- Flames including welding sparks, temperatures in excess of 140 °F (60 °C); and
- Mud, dirt, dust, debris and any other environmental condition that may damage the physical property values of the geotextile.

### 3.0 CONSTRUCTION REQUIREMENTS

**3.1 General.** Prepare the surface on which the geotextile is to be placed so that no damage occurs to the geotextile. Do not drive construction equipment on the geotextile. Dispose of material with defects, rips, holes, flaws, deterioration, or other damage. Do not use defective material in the work.

If sewn seams are used for seaming the geotextile, use thread that consists of high strength polypropylene or polyester. Do not use nylon thread. Use thread that is of contrasting color to that of the geotextile itself.

For seams that are sewn in the field, provide at least a 10-foot length of sewn seam for sampling by the RCE before the geotextile is installed. For seams that are sewn in the factory, provide samples as directed and witnessed by the RCE at random from any roll of geotextile that is used on the project.

For seams that are field sewn, use the same equipment and procedures for both the sampling and production seams. If seams are to be sewn in both the machine and cross-machine direction, provide samples of seams from both directions.

Submit the seam assembly description along with the sample of the seam. Include in the description the seam type, stitch type, sewing thread, and stitch density.

**3.2 Separation/Stabilization Geotextile.** Prepare the installation site by clearing, grubbing, and excavating or filling the area to the design grade. This includes removal of topsoil or vegetation. The RCE will identify soft spots and unsuitable areas during site preparation. Excavate these areas and backfill with approved granular material and compact as specified. Grade the area to be covered by the



## EXHIBIT 5 - SPECIAL PROVISIONS

geotextile to a smooth, uniform condition, free from ruts, potholes, and protruding objects such as rocks or sticks.

Spread the geotextile immediately ahead of the covering operation. Lay the geotextile smooth without wrinkles or folds on the prepared subgrade in the direction of construction traffic. Remove wrinkles and folds by pulling the geotextile taut as required. Use soil piles or the manufacturer's recommended method (as approved by the RCE) to hold the geotextile in place until the specified cover material is placed. Overlap, sew or join adjacent geotextile rolls and roll ends as shown on the plans or as directed by the RCE. Overlap in the direction shown on the plans. Overlap in accordance with the requirements of Table 4, or as specified on the plans or in the special provisions.

**TABLE 4 - OVERLAP REQUIREMENTS**

<b>UNDRAINED SHEAR STRENGTH OF SUBGRADE</b>	<b>MINIMUM OVERLAP</b>
> 2,000 psf	1 foot
500-2,000 psf	3 feet or Sewn
< 500 psf	Sewn
All roll ends	3 feet or Sewn

On curves, cut or fold the geotextile to conform to the curve. Fold or overlap in the direction of construction and hold in place using pins, staples, or piles of fill or rock.

Do not cover the geotextile until inspected for damage by the RCE. Repair or replace all damaged geotextile at Contractor's expense. Make repairs following the manufacturer's recommendation or use a patch of the same material placed over the damaged area, overlapped at least 3 feet from the edge of any part of the damage. Sewing repairs are an acceptable alternative.

Place fill over the geotextile by dumping onto previously placed material and pushing the material into place. Do not operate any construction equipment directly on the geotextile under any circumstances. Place the fill material in uniform layers so that there is the minimum specified lift thickness between the geotextile and equipment tires or tracks at all times. The minimum thickness of the first lift is 8 inches. Do not allow construction equipment to turn on the first lift of material above the geotextile. Do not blade the first lift placed over the geotextile. If the subgrade is very soft with an undrained shear strength less than 500 psf minimize pile heights to less than 3 feet and spread piles as soon as possible after dumping to minimize the potential for localized subgrade failure due to overloading of the subgrade.

Do not use sheepsfoot or studded compaction equipment on the first lift placed over the geotextile. Stop vibrator on compaction equipment if pumping occurs. Do not operate any construction equipment that results in rutting in excess of 3 inches on the first lift. If rutting exceeds 3 inches, decrease the construction equipment size and/or weight or increase the lift thickness. Use only rubber-tired rollers for compaction if any foundation failures occur when placing subsequent lifts. Compact all lifts to the moisture and density requirements for earth embankment specified in the Standard Construction Specifications. Do not blade material down to remove ruts. Fill any ruts or depressions with additional material and compact to the specified density.

#### **4.0 METHOD OF MEASUREMENT**

Geotextiles are measured by the square yard as staked by the RCE. Measurement excludes laps, seams, and joints.

#### **5.0 BASIS OF PAYMENT**

Payment at the contract unit price is full compensation for all resources necessary to complete the item of work under the contract. Payment for the completed and accepted quantities is made under the following:

**EXHIBIT 5 - SPECIAL PROVISIONS**

**Pay Item**  
Geotextile, Separation/Stabilization

**Pay Unit**  
Square Yard

**(73) DIVISION 200: BRIDGE LIFT MATERIALS**

Division 200 is expanded as follows.

**1.0 DESCRIPTION**

The requirements of this specification shall consist of furnishing all necessary submittals and materials for providing bridge lift materials in accordance with the details shown on the plans and the requirements of the Supplemental Specifications. The bridge lift materials shall be installed at locations shown on the plans, unless otherwise directed by the Department.

**2.0 MATERIALS**

The materials provided for under this specification shall be used for bridge lifts. Bridge lift materials shall consist of two general types, first materials that can be placed through water and those materials that are placed over soft exposed subgrades without water being present. The materials placed through water shall consist of either stone or coarse granular materials. The materials placed on soft exposed subgrades may consist of borrow excavation, stone or coarse granular materials.

**2.1 Stone Materials:** The stone materials shall meet the specification requirements of No. 57 or No. 67 Coarse Aggregate (stone) as described in the current edition of the SCDOT Standard Specifications for Highway Construction. The stone shall consist of durable particles that are comprised of naturally occurring materials including marine limestone or man-made materials. The man-made materials are limited to light weight materials that meet the gradation requirements previously indicated and have a unit weight of at least 65 pounds per cubic foot. The natural materials shall have a dry unit weight of at least 105 pounds per cubic foot. Recycled materials may not be used.

**2.2 Granular Materials:** The granular materials shall meet the specification requirements for an A-1-a (AASHTO M-145) as indicated in the following table.

<b>Sieve Analysis</b>	<b>Percent Passing</b>
No. 10	50 max.
No. 40	30 max.
No. 200	15 max.
<b>Plasticity Index</b>	6 max.
<b>Organics</b>	1 max.

The granular materials shall consist of durable, naturally occurring particles. The granular materials shall have a dry unit weight of at least 110 pounds per cubic foot. Recycled materials may not be used.

**2.3 Borrow Excavation Materials:** Borrow excavation materials used as a bridge lift shall be limited to A-1, A-2 and A-3 materials (AASHTO M-145). The borrow excavation materials shall meet the requirements as described in the current edition of the SCDOT Standard Specifications for Highway Construction.

**2.4 Submittals:** The contractor is required to submit copies of gradation testing to the Department prior to delivery of the material to the site and at the discretion of the RCE as placement proceeds, if in the opinion of the RCE additional verification of the gradation is required.

**3.0 METHOD OF MEASUREMENT**

**EXHIBIT 5 - SPECIAL PROVISIONS**

Stone bridge lift materials shall be measured by the ton (TON) when included in the Contract. Granular bridge lift materials shall be measured by the cubic yard (CY) when included in the Contract. The quantity of granular bridge lift material includes the material acceptably excavated and is measured in its original position and determined from cross-sections by the method of average-end-areas, complete and accepted. Borrow excavation bridge lift materials shall be measured and included the total borrow material required for the project.

**4.0 BASIS OF PAYMENT**

Unless otherwise specified, payment for the accepted quantity of material, as specified herein, measured in accordance with this specification, is determined using the contract unit bid price for the applicable pay item. Payment is full compensation for obtaining, hauling and placing the material and all other materials, labor, equipment, tools, supplies and incidentals necessary to satisfactorily complete the work as required in the Plans, Project Specifications and other terms in the Contract.

Where the Contractor is required to furnish the borrow pits for granular bridge lift material, payment for the granular bridge lift material includes the cost of the borrow pit, clearing and grubbing of pits, necessary haul roads, hauling of the borrow material to the designated location on the project and for all other pertinent stipulations stated above.

Payment of borrow excavation bridge lift material shall be included in the quantity of borrow excavation used on the project.

Payments shall be made under:

Item No.	Pay Item	Pay Unit
2052010	Stone Bridge Lift Material	TON
2052020	Granular Bridge Lift Material	CY

**(74) DIVISION 200: DEEP SOIL MIXING**

September 21, 2011

**1.0 Description.** This work shall consist of using deep soil mixing (DSM) construction techniques (also known as deep mixing methods, DMM) to improve weak subsurface soils by mixing a binder material with in-situ soil to produce a DSM column composed of a soil-binder mixture that has increased compressive strength and stiffness properties compared to the original in-situ soil properties. A column is defined as the extent that the existing ground is improved by insertion and removal of the mixing tool to the full improvement depth required in the plans. DSM column mixing methods allowed are described in subsection 1.1 and DSM column spacing requirements are described in subsection 1.2. The purpose for constructing DSM columns is to improve weak subsurface soils in order to stabilize and/or improve performance of existing ground prior to constructing bridge foundations, embankments, mechanically stabilized earth (MSE) walls, retaining walls, and other transportation structures or facilities as specified herein and shown on the plans and contract documents. References listed in subsection 1.3 may be used in these special provisions and will be used to evaluate this work.

The work covered by this specification includes furnishing all necessary plant, labor, equipment, geotechnical subsurface investigation, pre-production laboratory testing, test section(s), surcharges/berms constructed at the DSM improved locations (if shown in the plans or required to meet DSM column performance requirements), in-situ testing, sampling/coring, QA/QC testing, reporting, and

## EXHIBIT 5 - SPECIAL PROVISIONS

other work described below. The Contractor shall be familiar with project geotechnical conditions and recognize that geotechnical data is available with geotechnical boring logs, laboratory testing results, and other pertinent information.

**1.1 DSM Mixing Methods:** This special provision contains specifications for construction of DSM columns by either the wet or dry mechanical mixing method. The Contractor shall use the DSM mechanical mixing method specified in the plans unless other methods are approved in writing by the Engineer and the Department. DSM column mixing method for the wet and dry mixing methods are defined as follows:

- 1. Wet Method:** The wet method consist of mixing a binder in slurry form (i.e. cement grout) with existing soils using auger-type equipment (paddles, augers, and other rigid mixing tools), without use of externally directed high pressure jets, to form a DSM column consisting of a homogeneous mixture of cement grout and in-situ soils. The wet mixing method typically produces spoils in the range of 10 to 60 percent of the treated volume. A soil-cement column formed by the wet mixing method is abbreviated herein as DSM-SCC).
- 2. Dry Method:** The dry method consists of mixing dry binders (i.e. lime-cement or cement) into the in-situ soils. The dry binder is injected into the soil by using air pressure. The mixing tool blends the binder material with the in-situ soil and water to form a DSM column of a homogeneous mixture of binder materials and in-situ soils. The dry mixing method typically produces spoils less than 10 percent of the treated volume. A DSM column (lime-cement or cement) formed by the dry mixing method is abbreviated herein as DSM-LCC.

**1.2 DSM Column Spacing:** The DSM columns shall be spaced and arranged as indicated on the plans or as otherwise directed by the Engineer. DSM columns can be constructed by using group column spacing or by using block column spacing as described below:

- 1. Group Column Spacing (GCS):** DSM group column spacing (GCS) consists of constructing a single column (no overlap with adjacent DSM columns) with a diameter of 20 to 36 inches or as required in the plans. The DSM columns group spacing is defined in the plans by specifying a pattern (i.e. triangular, grid, etc.) and a center-to-center spacing between DSM columns.
- 2. Block Column Spacing (BCS):** DSM block columns spacing (BCS) consists of constructing an improved soil zone with DSM columns overlapping adjacent DSM columns. Since the improved soil zone is continuous, the size of the DSM column is not specified in the plans to accommodate variations in the Contractor's equipment dimensions. As a result of Contractor equipment variations in size, any variations in the dimensions of the zone of ground improvement shown in the plans will require written approval by the Engineer and the Department. The center-to-center spacing shall be determined by the Contractor based on the DSM construction equipment in order to provide continuous overlapped DSM columns in accordance with the plans and specifications. Continuous column spacing may be achieved by the use of DSM equipment capable of constructing multiple columns simultaneously. The DSM column overlap distance between adjacent DSM columns shall be a minimum of 20 percent of the DSM column diameter or as approved by the Engineer and the Department. The DSM column center-to-center spacing between adjacent columns shall be defined as the DSM column diameter minus the column overlap distance.

**1.3 References:** The evaluation of this work, including the DSM Installation Plan, test section(s), QC testing, and QA testing will be based on, but not limited to, the following references:

1. Bruce, D.A. (2000). "An Introduction to the Deep Soil Mixing Methods as Used in Geotechnical Applications, Volume I," FHWA-RD-99-138.
2. Bruce, D.A. (2000). "An Introduction to the Deep Soil Mixing Methods as Used in Geotechnical Applications, Volume II: Appendices," FHWA-RD-99-149.
3. Bruce, D.A. (2001). "An Introduction to the Deep Mixing Methods as Used in Geotechnical Applications, Volume III: The Verification and Properties of treated Ground," FHWA-RD-99-167.

## EXHIBIT 5 - SPECIAL PROVISIONS

4. Elias, V., Welsh, J., Warren, J., Lukas, R., Collin, J.G., and Berg, R.R., (2006). "Ground Improvement Methods," Volumes I and II, FHWA NHI-06-019 and FHWA NHI-06-020, US Dept. of Transportation, Federal Highway Administration.
5. Filz, G. M., Hodges, D. E., Weatherby, D. E., and Marr, W. A. (2005). "Standardized Definitions and Laboratory Procedures for Soil-Cement Specimens Applicable to the Wet Method of Deep Mixing." *Innovations in Grouting and Soil Improvement*, Reston, Virginia, 13.
6. Filz, G. M. and Stewart, M. E. (2005). "Design of Bridging Layers in Geosynthetic-Reinforced, Column-Supported Embankments." Virginia Transportation Research Council, Charlottesville, VA
7. Jacobson, J. R., Filz, G. M., and Mitchell, J. K. (2003). "Factors Affecting Strength Gain in Lime-Cement Columns and Development of a Laboratory Testing Procedure," Report prepared for the Virginia Transportation Research Council, Virginia Polytechnic Institute and State University, Report No. 57565, FHWA/VTRC 03-CR16.
8. Jacobson, J. R., Filz, G. M., and Mitchell, J. K. (2005). "Factors Affecting Strength of Lime-Cement Columns Based on a Laboratory Study of Three Organic Soils." Deep Mixing '05: International conference on deep mixing best practice and recent advances.
9. Larsson, S. (2005a). "State of Practice Report – Execution, monitoring and quality control," Volume 2, Deep Mixing '05: International Conference on Deep Mixing Best Practice and Recent Advances.
10. Larsson, S. (2005b). "On the use of CPT for quality assessment of lime-cement columns." Deep Mixing '05: International Conference on Deep Mixing Best Practice and Recent Advances.
11. McGinn, A. J. and O'Rourke, T. D. (2003). "Performance of deep mixing methods at Fort Point Channel." Cornell University.

### 2.0 Materials.

#### 2.1 Wet Method (DSM-SCC):

*Cement:* Portland cement shall be low alkali Type II conforming to Section 701.2.1 and ASTM C150. Slag cement shall conform to Section 701.2.3 and ASTM C 989. All cement shall be homogeneous in composition and properties, and shall be manufactured using the same methods at one plant by one supplier. Tricalcium aluminate content shall not exceed 7 percent.

*Water:* Water shall conform to the requirements of Section 701.2.11.

*Admixtures:* Cement admixtures will not be allowed without written approval by the Engineer. Cement admixtures are ingredients that are used to permit efficient use of materials and proper workability of the binder material being mixed into the in-situ soils. The Contractor is required to submit any proposed admixtures and their intended effect when the binder mix design is submitted for approval by the Engineer and the Department.

*Cement Grout:* The cement grout shall be a stable homogeneous mixture of cement, admixtures (if approved), and water in proportions determined by the results of the test section and approved by the Engineer and the Department. The cement grout is mixed with the in-situ soils to form DSM-SCC columns.

*Soil-Cement Mixture:* The DSM column shall be composed of a stable and uniform soil-cement mixture of cement grout and in-situ soil that meets the project compressive strength and other requirements in the plans and these special provisions. The proposed ratios of concrete grout to in-situ soils and quantities of various components shall be determined by the results of the test section and approved by the Engineer and the Department.

**2.2 Dry Method (DSM-LCC):**

*Cement:* Portland cement shall be low alkali Type II conforming to Section 701.2.1 and ASTM C150. Slag cement shall conform to Section 701.2.3 and ASTM C 989. All cement shall be homogeneous in composition and properties, and shall be manufactured using the same methods at one plant by one supplier. Tricalcium aluminate content shall not exceed 7 percent.

*Quick Lime:* Quick lime shall have at least 99 percent passing the #8 sieve (3.18 mm) and at least 90 percent passing a No. 12 Sieve (2.12 mm), an active CaO content greater than 80% and a floatability of 70.

*Premixed Lime-Cement:* If a premixed quick lime and cement is to be used, the manufacturer of the mixture must certify that the proportions of lime and cement provided are in accordance with the design requirements developed from the test section and approved by the Engineer and the Department.

*Admixtures:* Cement admixtures will not be allowed without written approval by the Engineer. Cement admixtures are ingredients that are used to permit efficient use of materials and proper workability of the binder material being mixed into the in-situ soils. The Contractor is required to submit any proposed admixtures and their intended effect when the binder mix design is submitted for approval by the Engineer and the Department.

*Binder:* The binder will be a stable homogeneous mixture of cement, lime (if applicable), and admixtures (if approved), in proportions determined by the results of the test section and approved by the Engineer and the Department. The binder material is delivered using air pressure and is mixed with the in-situ soils to form DSM-LCC columns.

*Soil-Binder Mixture:* The DSM column will be composed of a stable and uniform soil-binder mixture that meets the project design requirements and these special provisions. The proposed ratios of binder material to in-situ soils and quantities of various components shall be determined by the results of the test section and approved by the Engineer and the Department.

**3.0 Submittals.** A minimum of 45 calendar days prior to beginning the DSM work, the Contractor shall submit a DSM Construction Plan and Shop Plans/Working Drawings for review and approval by the Engineer and the Department. The DSM Construction Plan and Shop Plans/Working Drawings shall be prepared, signed, and sealed by an agent/representative of the DSM Contractor that is a professional engineer licensed in the State of South Carolina. The Contractor shall not commence DSM installation without the approval of all submittals by the Engineer and the Department. Approval by the Engineer and the Department will not relieve the Contractor of its responsibilities to provide materials and equipment necessary to install DSM columns in accordance with the plans and specifications. If, at any time, the Engineer or the Department considers that the Contractor's installation operation does not produce a satisfactory DSM column, the Contractor shall alter its method and/or equipment as necessary to comply with the plans and specifications at no additional cost to the Department.

The Contractor shall submit 8 sets of the DSM Construction Plan and 8 sets of Shop Plans/Working Drawings to the Preconstruction Support Engineer (PSE) for review in accordance with the requirements provided herein. Send DSM Construction Plan and Shop Plans/Working Drawings for projects designed for the Department by a design consultant directly to the consultant. For DSM Construction Plan and Shop Plans/Working Drawings sent to the PSE, send a copy of the transmittal letter to the BCE, the OMR, and the RCE. For Shop Plans sent directly to a design consultant, send a copy of the transmittal letter to the PSE, the BCE, the OMR, and the RCE. Obtain the necessary mailing information at the Preconstruction Conference. For Design Build projects, DSM Construction Plan and Shop Plans/Working Drawings submittal is subject to change and shall be coordinated with the RCE.

**3.1 DSM Construction Plan:** The DSM Construction Plan shall document and provide, as a minimum, the following information:

## EXHIBIT 5 - SPECIAL PROVISIONS

1. *Qualifications:* Evidence of six years of accumulated experience over a period of 10 years and competence to construct the required DSM columns by the mixing method (i.e. wet or dry) required for the project shall be submitted. As a minimum, the Contractor shall submit a detailed description of three DSM projects completed using the required mixing method within the previous six years that demonstrate the Contractor's experience and competence. Jet grouting or penetration grouting projects will not be acceptable as representative of DSM construction techniques. Each DSM project submitted as proof of experience and competence shall have a minimum total treatment volume of not less than 20 percent of the DSM treatment volume for this project or 30,000 cubic yards of DSM treatment volume, whichever is greater, in high plasticity clay, sand, and silt. At least two of the submitted DSM projects using the required mixing method shall have average treatment depths greater than 60 feet. Each DSM project submitted shall have the following information:
  - a. Project name, location, and completion date.
  - b. Current contact information (address, phone number, and email) of project owner, designer, geotechnical consultant, and contract manager.
  - c. Surface and subsurface conditions, and strength (average, ranges, and means used to determine strength) of DSM columns installed.
  - d. Minimum, maximum, and average rates of DSM installation.
  - e. Project cost and duration of DSM installation.
  - f. Average depths and ranges of depths of DSM columns installed. Provide total linear footage and volume (cubic yards) of DSM columns installed.
  - g. Percent of project total based on QA/QC testing that met the project Acceptance Criteria and percent of project total based on QA/QC testing that required remediation techniques after initial DSM installation.

The Contractor shall also submit a list of completed ground improvement projects where they performed DSM column construction techniques over the past six years that includes items "a" and "e" listed above, type of DSM mixing, and DSM quantity constructed (similar to item "f" above).

The Contractor's proposed DSM superintendent shall have a minimum of three years of accumulated experience with DSM construction equipment and construction management within the past six years. The DSM superintendent shall have been employed by the Contractor for the most recent three years. The proposed DSM superintendent shall have been superintendent for the Contractor on at least one of the three DSM projects submitted by the Contractor as evidence of their experience. Experience and training records shall be submitted for proposed DSM superintendent and operators of construction equipment. Any changes in DSM construction personnel shall require submittal of qualifications for approval.

The Independent Testing Laboratory shall have at least 5-years' experience as a materials testing laboratory, including the performance of testing comparable to that required herein. The person in charge of the testing work for the Independent Testing Firm shall be a Professional Civil Engineer, registered in the State of South Carolina. The Independent Testing Laboratory's supervisor and each field representative who will take samples in the field shall have at least 5-years' experience in taking concrete samples in the field and performing compressive strength tests in accordance with AASHTO requirements, and be accredited as required by SCDOT to obtain and form concrete test cylinders. The persons who will perform laboratory testing shall have at least 2-years' experience in performing the soil tests required herein.

2. *Protection of Utilities:* Location of all subsurface utilities in the area and the plan to protect them in place if the utilities are not being relocated out of the affected area.
3. *Construction Schedule:* A construction schedule for the DSM work identifying start dates and durations for all portions of the work, including equipment mobilization, equipment setup, test section(s) construction, production DSM construction at each location, and QC testing.

## EXHIBIT 5 - SPECIAL PROVISIONS

4. *DSM Mixing Method:* Provide the type of mixing method (Wet or Dry) that will be used in accordance with the plan documents to construct the DSM columns in accordance with the plans and these specifications.
5. *Equipment and Procedures:* A detailed description of the equipment (include catalog cut sheets of equipment dimensions) and procedures to be used during all facets of the project including, but not limited to the conduct of the following:
  - a. Test section(s)
  - b. Site preparation
  - c. Stage construction of DSM test section(s) and production DSM (if required)
  - d. Locating the DSM columns in the field
  - e. DSM spoil containment, handling, and disposal
  - f. Confirming method to check that the DSM are installed plumb
  - g. Quality control program
  - h. Monitoring quality control parameters
  - i. Sample collecting for laboratory confirmation testing
6. *DSM Test Section Subsurface Information and Location:* Submit the probe testing results used to pre-approve the location of the test section(s). Provide a minimum of two probe test at each test section in accordance with Section 8.2 for review and approval by the Engineer and the Department of the proposed location of the test section(s). Pre-approval of the test section location(s) shall be required before commencing Pre-production field and laboratory testing (Section 4.0). Probe testing shall be conducted to the production DSM depths plus 10 feet that the test section represents. Indicate on a plan drawing the location of the test section(s), dimensions and layout of the test section(s), number of DSM columns (include designation of each DSM column), and location of probe testing performed (Section 8.2). This information should be included in this submittal even if submitted previously during pre-approval of DSM test section location(s).
7. *Pre-Production DSM Binder Mix Design Report:* Final report of pre-production laboratory and field testing used to develop proposed wet or dry binder mix design for the construction of the test section(s). The pre-production laboratory and field testing shall conform to Section 4.0 of this special provision.
8. *Cement and Cement Grout Mix Design (Wet Mixing Method, DSM-SCC):* Proposed cement and cement grout mix design when DSM columns are constructed using the wet mixing method (DSM-SCC). The design shall include the following:
  - a. Cement type and Cement manufacturer's certificate of compliance.
  - b. Cement grout water-cement ratio, by weight. Include details to fully describe and illustrate the methods for grout proportioning to achieve the design mix.
  - c. Cement Factor (also known as Residual Cement Factor) which is the amount of cement, dry weight in pounds, that remains in the ground after mixing, per cubic yard of in-situ soil-cement.

These mix design parameters will be reviewed based on the pre-production field and laboratory testing results developed in accordance with Section 4.0. The acceptance of the proposed grout mix/soil/cement mix design shall be contingent on the test section(s) results meeting the acceptance criteria of Section 11.0. The Contractor may propose to expand the size of the test section to demonstrate that somewhat different grout water/cement ratio and/or cement factor is workable in achieving the required soil-cement strength under actual in-situ conditions. Provide documentation of calibration of the mixing plant.

9. *Binder Mix Design (Dry Mixing Method, DSM-LCC):* Proposed binder mix design(s) when DSM columns are constructed using the dry mixing method (DSM-LCC). Binder mix design shall



## EXHIBIT 5 - SPECIAL PROVISIONS

include all materials, quantities, and dosages required to achieve the Acceptance Criteria (Section 11.0). The design shall include the following:

- a. Cement type and Cement manufacturer's certificate of compliance.
- b. Quick lime (if used) manufacturer's certificate of compliance.
- c. Pre-mixed lime-cement (if used) manufacturer's certificate of compliance
- d. Binder mix dosage of each material in the binder mix per volume.
- e. Proportion of binder material to soil in the soil-binder mixture.

These mix design parameters will be reviewed based on the pre-production field and laboratory testing results developed in accordance with section 4.0. The acceptance of the proposed binder and soil/binder mix design shall be contingent on the test section(s) results meeting the acceptance criteria of section 11.0. The Contractor may propose to expand the size of the test section to demonstrate that somewhat different binder mix design is workable in achieving the required soil-binder strength under actual in-situ conditions. Provide documentation of calibration of the mixing plant.

10. *Independent Laboratory Testing*: Identification of all independent AASHTO certified materials laboratory testing facilities that will be used on the project and the type laboratory testing that will be conducted at each laboratory. All laboratory testing shall be performed at a materials laboratory with current AASHTO certification for the type of test being conducted. A single independent AASHTO certified materials testing laboratory shall be used to conduct all of the compressive strength testing that will be performed on the project.
11. *Calibrations*: Calibration tests for all metering equipment, including mixing systems, delivery systems, alignment systems, mixing tool rotational and vertical speed, injection pressure, rotation penetration/extraction rates, etc. that are applicable to the mixing method being used on the project.
12. *Surcharges/Berms*: Details of any surcharges/berms being constructed as indicated in the plans or required to obtain DSM column performance in accordance with plans and specifications. Provide a description of materials used (soil type, atterberg limits, moisture content, etc.), location, and removal schedule (if required). Surcharges that are required to obtain DSM column performance and are not shown in the plans shall be constructed after being approved by the Engineer and the Department and at no additional cost to the Department.
13. *Runoff and Spoil Containment (Wet Mixing Method Only)*: Details of all run-off and spoil containment structures will be required when DSM columns are constructed using the wet mixing method (DSM-SCC). These structures will be used to prevent the migration of either cement grout or soil-cement return spoils, disturbed in-situ soils, or other soil material beyond the immediate limits of the soil-cement mixing operation. Also provide description of processes and procedures to be used to collect and retain the soil-cement return and other spoil materials in such manner to allow the spoils to solidify for the necessary time to become a hardened material resembling a hard, dry cohesive material. The resulting hardened spoils shall be disposed of off-site, at no additional cost to the Department.
14. *Daily Production Control Report and Installation Log*: Provide a sample report and installation log in paper and electronic format that will be used to record the construction of all production DSM columns for the required mixing method. The Daily Production Control Report/Log shall contain at least the following information:
  - a. Project Name.
  - b. DSM column number and reference drawing number.
  - c. Date.
  - d. Name of DSM Superintendent and equipment operator.
  - e. Start/Finish time of DSM column installation.

## EXHIBIT 5 - SPECIAL PROVISIONS

- f. Machine/Rig Number.
- g. Type of mixing tool and indicate if single or multiple columns formed per stroke.
- h. DSM column(s) diameter/size.
- i. DSM column(s) total length (include top and bottom elevations).
- j. DSM column center-to-center spacing from adjacent DSM column.
- k. Verticality of mixing tool in two orthogonal planes for each DSM column.
- l. Binder mix design designation used.
- m. A description of obstructions, interruptions, DSM column construction out of tolerance or other difficulties encountered during installation of DSM column and how they were resolved.
- n. *Material Certifications*: Supplier's certifications of binder materials quality and other additives, if used.

Wet Mixing Method (DSM-SCC) reports shall include the following:

- o. Final current draw for the drilling equipment at the bottom 2 feet of penetration or final hydraulic pressure, if hydraulic motors are used to turn the mixing tools.
- p. Grout injection pressure and volume
- q. Estimate of spoil volume
- r. Target and actual cement factors and grout specific gravity measurements per DSM-SCC column.
- s. Date, time, plan location, and elevation and other details of all soil-cement wet grab samples and any other samples taken during work shift.
- t. The following information shall be logged using automated computer technology for each DSM-SCC installed at intervals no greater than 4 feet and presented in table and graphical forms:
  - Elevation in feet.
  - Mixing tool rotation penetration and withdrawal speed in revolutions per minute vs. depth in feet.
  - Mixing tool rotation penetration and withdrawal rates in feet per minute vs. depth in feet.
  - Mixing tool withdrawal rate in mm/revolution vs. depth in feet.
  - Grout injection rate in gallons per minute vs. depth in feet.
  - Average quantity of grout injected in gallons per foot injected per vertical foot of DSM-SCC vs. depth in feet.

Dry Mixing Method (DSM-LCC) reports shall include the following:

- o. Installation air pressure at tip and top of the lime-cement column.
- p. Target and actual binder dosage mixed per DSM-LCC column.
- q. The following information shall be logged using automated computer technology for each DSM-LCC installed at intervals no greater than 4 feet and presented in table and graphical forms:
  - Elevation in feet.
  - Mixing tool rotation penetration and withdrawal speed in revolutions per minute vs. depth in feet.
  - Mixing tool rotation penetration and withdrawal rates in feet per minute vs. depth in feet.
  - Mixing tool withdrawal rate in mm/revolution vs. depth in feet.
  - Quantity of binder reagent (i.e. quick lime, cement, and admixtures) injected in kg/ft
  - Average binder reagent injected in kg per foot injected per vertical foot of DSM-LCC vs. depth in feet.

**3.2 Shop Plan/Working Drawing:** The Shop Plan/Working Drawing shall contain the location and extent of all production DSM columns that will be constructed as indicated in the plans. Indicate DSM column

## EXHIBIT 5 - SPECIAL PROVISIONS

spacing and overlap dimensions, including overall dimensions of ground improvement area. Provide the production DSM column numbering system/identification for each location where DSM columns will be constructed. Provide the sequence of DSM column construction that will be used to minimize the effects of ground movements on adjacent existing structures (i.e. MSE walls). The Shop Plan/Working Drawing shall be prepared, signed, and sealed by a professional engineer licensed in the State of South Carolina.

**4.0 Pre-Production Field and Laboratory Testing.** A pre-production field and laboratory testing program will be required to develop the proposed DSM wet or dry binder mix design prior to the construction of the test section(s). The field testing program consists of conducting a geotechnical subsurface investigation in accordance with subsection 4.1 of this special provision. Soil samples obtained from the geotechnical subsurface investigation shall be used to develop and conduct the pre-production laboratory testing. The pre-production laboratory testing will be required to establish a "base line" of the degree of ground improvement that is possible under optimal construction circumstances for various DSM binder mixes for each distinct soil type that will be encountered during the conduct of the DSM ground improvement. It is recognized that the pre-production laboratory testing will be used as a general indicator of ground improvement that may be obtained in-situ because of substantial differences inherent between laboratory and in-situ mixing conditions. The Contractor shall take appropriate account of these differences, based on published documents and the Contractor's experience, to develop a DSM binder mix design that can be used for constructing the test section(s) based on the results of the pre-production laboratory testing. A pre-production laboratory testing program shall be required for each test section. A DSM binder mix design shall be developed for each major soil type encountered throughout the depth of ground improvement. As a minimum, two binder mix designs for two types of soil shall be required per test section. The minimum pre-production laboratory testing requirements for wet and dry mixing methods are provided in subsections 4.2 and 4.3 of this special provision, respectively.

The Contractor shall submit the geotechnical subsurface investigation plan of the proposed field sampling and laboratory testing to the Engineer **and the Department** for review and approval a minimum of 14 calendar days prior to commencing the geotechnical subsurface investigation. The Contractor shall submit the results of the geotechnical subsurface investigation and the pre-production laboratory testing plan to the Engineer **and the Department** for review and approval a minimum of 14 calendar days prior to commencing the pre-production laboratory testing. The results of the pre-production field and laboratory testing along with the proposed DSM binder mix designs shall be included in the DSM Installation Plan submittal in accordance with section 3.0.

**4.1 Geotechnical Subsurface Investigation:** In-situ soils used for the pre-production laboratory testing shall be obtained from additional subsurface investigation conducted at or near the location of the approved test section(s) locations. The Contractor shall retain the services of a geotechnical consultant to drill several 3-inch continuously sampled soil borings to obtain sufficient material to perform the pre-production laboratory testing. The sampling shall be performed in such a manner that provides continuous, representative samples of the soil column. This can be effectively accomplished via Geoprobe sampling techniques, undisturbed sampling in fine-grained soils, split-spoon sampling, or any other sampling technique proposed by the Contractor and approved by the Engineer **and the Department**.

Contractor shall check for utility conflicts at boring locations with appropriate utility agencies, survey boring locations and survey locations tied to the project baseline alignment. The borings shall extend from the ground surface to the bottom elevation of the DSM columns shown in the plans to establish general soil and groundwater conditions in the vicinity of the work prior to construction of the test section(s). The geotechnical investigation shall be done in conformance with the latest version of the SCDOT Geotechnical Design Manual (GDM). SCDOT practices including but not limited to boring logs and laboratory data reporting shall be used. The geotechnical consultant shall classify and record soil types within 7 days of obtaining the samples in the field. The Geotechnical consultant shall perform laboratory testing on representative samples of the entire soil profile that will be subject to ground improvement. As a minimum, test six representative samples of cohesive soils taken from different locations and four representative samples of cohesionless soils taken from different locations. The laboratory testing, as a minimum, will consist of the following:

## EXHIBIT 5 - SPECIAL PROVISIONS

- Cohesive and organic soils (i.e. peat) will be subject to laboratory tests that include, but not be limited to, moisture content, Atterberg limits, organic content, and unconfined compression tests.
- Cohesionless soils will be subject to laboratory tests that include, but not be limited to, grain size analysis, fraction passing #200 sieve, Atterberg Limits, and moisture content.

All soil samples to be used for the pre-production laboratory testing shall be stored in a manner that prevents any loss of moisture and in accordance with ASTM. Do not allow field samples of the clay to lose moisture between the time of removal from ground and pre-production laboratory mixing/testing.

**4.2 Pre-Production Laboratory Testing.** Pre-Production laboratory testing will require the development of a DSM binder mix testing program for each type of soil where ground improvement will be performed to demonstrate that the required 28-day compressive strength indicated in the plans will be achieved. The soils obtained from the geotechnical subsurface investigation performed (Subsection 4.1) will be used to perform the laboratory testing. All soil and mixed samples shall be kept out of sunlight at 70 degrees F and under fully humid conditions throughout storage and curing that prevents loss of sample moisture via evaporation.

DSM constructed using the wet mixing method (DSM-SCC) will require that the testing laboratory prepare the soil, mix the binder reagent (i.e. cement, etc.) and water to make grout, and then mix grout and soil together. The specimens shall be mixed using a minimum of four different DSM binder mixes to provide insight into the relationship of cement factor and grout water/cement ratio on the 28-day compressive strength of the soil-binder specimens. Binder materials and individual proportions of cement or admixtures (if used) used shall be documented for each specimen. The procedures outlined by Filz and Stewart (2005) may be used to provide guidance in developing a laboratory testing program.

DSM constructed using the dry mixing method (DSM-LCC) will require that the testing laboratory prepare the soil, binder reagent, and then mix the soil (at the same in-situ moisture) and binder reagent together. The specimens shall be mixed using a minimum of four different DSM binder mixes to provide insight into the relationship of binder proportions on the 28-day compressive strength of the soil-binder specimens. Binder materials and individual proportions of lime, cement, and admixtures (if used) used shall be documented for each specimen. The procedures outlined by Jacobson et. al (2003, 2005) may be used to provide guidance in developing a laboratory testing program.

All test specimens shall be prepared using the lab mixing energy level similar to energy levels used by the Contractor's field equipment. Test specimen cylinders shall be prepared according to procedures submitted to the Department and approved. Strength test three cylinders of soil-binder mixture at 3, 7, 14, 28, and 56 days following mixing. Strength testing shall be performed in accordance with subsection 8.4.

### 5.0 Delivery, Storage, and Handling of Materials.

**5.1 DSM Wet Mixing Method (DSM-SCC):** Portland cement shall be measured, handled, transported, and stored in bulk in accordance with the manufacturer's recommendations. Portland cement packaged in cloth or paper bags shall be sealed with plastic or rubber vapor barriers. The Portland cement shall be stored to prevent damage by moisture. Materials that become caked due to moisture absorption shall not be used. Bags of cement shall be stacked no more than ten bags high to avoid compaction. Cement containing lumps or foreign matter of a nature that may be deleterious to the grout mixing or delivery or injection operations shall not be used.

**5.2 DSM Dry Mixing Method (DSM-LCC):** The quicklime and cement shall be stored in closed pressure tanks suitable to be used as pressure vessels, for all pressures required, including those used to load and unload the materials. Delivery trucks shall be loaded at the manufacturer's plant unless approval is given for an intermediate storage facility. Each truck shall have a certified record of the weight of each load of material. The material shall be transported to the project site and blown into the on-site storage tanks using a pneumatic system. The air evacuated from the storage tanks during the loading process shall be filtered before being discharged to the atmosphere. A sealed refilling machine shall be used to transport

## EXHIBIT 5 - SPECIAL PROVISIONS

material from the storage tanks to the DSM column mixing machine. This machine shall be refilled using a pneumatic system and an air filter, as specified above.

**6.0 Installation Equipment.** The DSM column construction equipment and support equipment shall be equipped with mixing tools that are capable of thoroughly blending the in situ soils and binder material into a homogeneous column of soil-binder to the depths and size required in the plans. The equipment shall be capable of advancing through previously installed and cured DSM columns as necessary for installing overlapping and end junction DSM columns. The DSM columns shall be constructed using computerized self-contained construction equipment.

**6.1 DSM- SCC Construction Equipment:** The DSM-SCC construction equipment shall meet the following requirements:

1. DSM-SCC shall be constructed using real-time computerized self-contained DSM-SCC construction equipment capable of monitoring, controlling, and recording installation data. The DSM-SCC construction equipment shall be equipped with electronic sensors, built into the soil mixing equipment, to perform the following:
  - a. Determine vertical alignment of the leads in two directions: fore-aft and left-right. The verticality shall be measured using instrumentation that is capable of measure deviations from verticality to an equivalent of 1-inch in 100-feet.
  - b. Monitor cement and water proportioning, grout mixing, and water-cement ratios.
  - c. Monitor the mixing tool depth and penetration/withdrawal speed, and mixing tool rotation speed.
  - d. Monitor mixing tool withdrawal speed, and mixing tool rotation speed.
  - e. Monitor injection quantities and pressure with flow meter and other measuring equipment having precision accuracy not less than 99.5 percent.
  - f. All output from the sensors shall be routed to a console that is visible to the operator and the Engineer during penetration and withdrawal.
  - g. The sensors shall be calibrated at the beginning of the project and calibration data provided to the Engineer and the Department. The calibration shall be repeated at intervals not to exceed one month.
  - h. All of these monitored functions shall be fully adjustable during operation of the equipment.
2. The DSM-SCC construction equipment power source for driving the mixing tool shall be sufficient to maintain the required revolutions per minute (RPM) or injection pressure and penetration rate from a stopped position at the maximum depth required as determined from the test section(s) for group and/or block DSM column spacing. The Contractor shall also consider the wide range of expected subsurface conditions, indicated by the available geotechnical information.
3. The DSM-SCC construction equipment shall utilize sufficient mixing and injecting equipment to adequately produce a homogeneous distribution of cement grout throughout the mixed in-situ soils that meet the acceptable criteria. The mixing tools shall uniformly inject cement grout through hollow stem or other piping at locations that distribute the grout across the full diameter of the mixing tools and such that the full auger/mixing paddle assembly passes through the column of soil after the grout is introduced, on both the insertion and withdrawal strokes. Grout shall only be injected in direction within the diameter of the augers or mixing paddles. If grout injection jets are used, they shall not spray beyond the auger diameter.
4. Continuous auger flights longer than 3 feet or with more than one full, uninterrupted revolution of auger are not allowed as part of the mixing tools. Auger flights and mixing paddles on a shaft shall all reach to the full column diameter, and shall have discontinuous lengths and be so oriented as to thoroughly break up the in-situ soils, and disperse and blend soils with injected cement grout to form a homogeneous soil-cement mixture.

## EXHIBIT 5 - SPECIAL PROVISIONS

5. The auger mixing equipment shall form the required diameter and size of the DSM-SCC as submitted by the Contractor's approved submittals.
6. Injection volume estimates shall be only made by precision inline flow meters. Counting or measuring grout pump strokes shall not be acceptable. Injection quantities must be measured in real time by direct measurements of volume and/or mass for each DSM column having injection capabilities, with flow meters and other measuring equipment having precision accuracy not less than 99.5%. Gages and flow meters and other measuring equipment shall be calibrated and certified as precise and accurate before the start of the equipment's work on the project, and then again every 4 months.
7. The DSM-SCC construction equipment shall be adequately marked to allow the Engineer and the Department to confirm the penetration depth to within 6 inches during construction.
8. The cement grout batching plant shall include all storage silos and sheds, pumps, scales, mixers, valves, gauges, and regulating devices required to continuously measure and mix cement grout in real time. Grout shall be mixed in a mixing plant, using a batch process, which combines dry materials and water in predetermined proportions. The plant mixer shall consist of grout mixer, grout agitator, grout pump, automatic batching scales, and a computer control unit. The mixing plant shall meet the following requirements:
  - a. To accurately control grout mix proportions, the addition of water and cement shall be determined by weight using automatic batch scales in the mixing plant.
  - b. Admixtures, if used, may be delivered to the mixing plant by calibrated auger provided the Contractor can demonstrate that the auger can deliver the material at the same accuracy as by weight.
  - c. The mixing components shall be calibrated prior to beginning the work and monthly thereafter. The calibration data shall be provided to the Engineer and the Department.
  - d. The mixing plant shall have tanks or silos with adequate storage for continuous production. The tanks shall be equipped with air filters.
9. Positive displacement pumps shall be used to transfer the grout from the mixing plant to the mixing tool. If the DSM-SCC construction equipment has multiple shafts, and multiple mixing tools, the grout shall be delivered to each shaft by an individual positive displacement pump.
10. All gauges, flow meters, metering equipment, and other measuring equipment shall be calibrated and certified as precise and accurate before starting DSM column construction (i.e. test section(s) or production DSM columns), and then again every 4 months or at least every 325,000 feet of DSM column installed, whichever is sooner. The calibrations and certifications shall be supplied to the Engineer and the Department.

**6.2 DSM- LCC Construction Equipment:** The DSM-LCC construction equipment shall meet the following requirements:

1. DSM-LCC shall be constructed using real-time computerized self-contained DSM-LCC construction equipment capable of monitoring, controlling, and recording installation data. The DSM-LCC construction equipment shall be equipped with electronic sensors, built into the soil mixing equipment, to perform the following:
  - a. Determine vertical alignment of the leads in two directions: fore-aft and left-right. The verticality to an equivalent of 1-inch in 100-feet.
  - b. Monitor the mixing tool depth, penetration/withdrawal speed, mixing tool rotation speed, and injection pressure.
  - c. All output from the sensors shall be routed to a console that is visible to the operator and the Engineer during penetration and withdrawal.
  - d. The sensors shall be calibrated at the beginning of the project and calibration data provided to the Engineer and the Department. The calibration shall be repeated at intervals not to exceed one month.

## EXHIBIT 5 - SPECIAL PROVISIONS

- e. An alternative display/monitoring system may be used subject to review and approval by the Engineer and the Department prior to use.
  - f. All of these monitored functions shall be fully adjustable during operation of the equipment.
2. The DSM-LCC construction equipment power source for driving the mixing tool shall be sufficient to maintain the required revolutions per minute (RPM) or injection pressure and penetration rate from a stopped position at the maximum depth required as determined from the test section. The Contractor shall also consider the wide range of expected subsurface conditions, indicated by the available geotechnical information.
  3. The DSM-LCC construction equipment shall be adequately marked to allow the Engineer and the Department to confirm the penetration depth to within 6 inches during construction.
  4. All gauges, flow meters, metering equipment, and other measuring equipment shall be calibrated and certified as precise and accurate before the starting DSM column construction (i.e. test section(s) or production DSM columns), and then again every 4 months or at least every 325,000 feet of DSM column installed, whichever is sooner. The calibrations and certifications shall be supplied to the Engineer and the Department.

**7.0 Construction Requirements.** The Contractor shall furnish all materials, labor and equipment necessary to construct the DSM columns in accordance with the plans and specification. The DSM columns shall be constructed to the lines, grades, and cross sections indicated in the Plans. The completed DSM improved zone shall be a homogeneous mixture of binder material constructed in accordance with the method of mixing and column spacing indicated in the plans.

Production DSM shall be constructed using the same equipment and construction criteria (i.e. mix design, mixing parameters, etc.) established in the accepted test section construction (subsection 9.0). DSM construction that is out of tolerance (subsection 7.4) or is subject to unforeseen conditions (subsection 7.5) shall be evaluated and corrected as approved by the Engineer and the Department with no additional cost or schedule impact to the Department.

**7.1 Site Preparation:** The presence and location of buried pipes, sewers, and other utilities shall be identified and precautions taken to protect the utilities from damage during the construction of the DSM columns. The Contractor shall be responsible for any damage resulting from the construction of the DSM columns. The site shall be cleared and grubbed in accordance with the Contract documents. Limit grubbing to that needed to remove previous construction materials, trees, stumps, and large roots. Fill in holes left by construction materials, stumps and root extraction and grade to provide level working surface. Place bridge lift materials as required in the plans and contract documents.

Establish DSM column limits and locations by a licensed surveyor. Individual column locations shall be marked. Sufficient horizontal and vertical control shall be provided to establish that DSM columns are located accurately and reach the required plan depths.

**7.2 DSM-SCC Soil-Grout Mixing:** Soil shall be broken up and blended with grout in place by the pugmill type action of the soil mixing equipment. The completed DSM-SCC shall be a uniform mixture of cement and the in situ soils. The soil-grout mixture shall achieve an average unconfined compressive strength in 28 days as indicated in the plans. Soil mixing shall be performed with the following minimum requirements:

1. *Grout Preparation:* The dry materials shall be fed to the mixers for agitation and shearing. The mixing ratio of the grout shall be controlled by measuring the weight of grout components using automatic batch scales in the mixing plant. Grout mixture shall be mixed for a minimum of three minutes, with a maximum holding time of two hours, calculated from the beginning of initial mixing. The specific gravity of the grout (determined in the test section) shall be tested at least once per shift per rig, using the methods outlined in ASTM D 4380, and shall not deviate more than three percent from the calculated specific gravity for the design cement ratio. Additional tests

## EXHIBIT 5 - SPECIAL PROVISIONS

may be required by the Engineer **or the Department**. If the specific gravity or density is lower than the design mix, the Contractor shall add additional cement, remix, and/or recalibrate batch scales and retest the grout until the design density is achieved, at no additional cost to the Department.

2. *Grout Injection*: The grout shall be pumped through and injected from the mixing tool. The grout injection rate per vertical foot of DSM-SCC shall be in accordance with the requirements of the design mix established during the test section. Injection rates falling below this requirement, shall require the DSM-SCC to be remixed and additional grout injected (at the design grout-soil ratio) to a depth at least three feet below the deficient zone, at no additional cost to the Department. The Contractor may sample using wet grab methods for his own purposes. The Department will not accept results from wet sampling for quality control purposes.
3. *Rotation Speeds*: The mixing tool rotational speeds (measured in RPM) and penetration/withdrawal rates shall be in accordance with the parameters established during the test section(s). If these parameters are varied more than 15 percent from those determined during the test section(s), the DSM-SCC section shall be remixed while injecting grout at the design grout ratio to a depth at least three feet below the deficient zone, at no additional cost to the Department.
4. *On-Board Computer*: The preset data in the on-board computer shall be verified for each column as correct and adjusted if necessary. The operator shall monitor and adjust as necessary during column installation the feeding of material, the grout injection rate, the mixing tool rates of rotation, and penetration/withdrawal rates of the mixing tool.
5. *Changes in Grout Mix Design*: The Contractor may request that the established grout mix be modified during the production DSM-SCC installation. To verify acceptable results for the modified mix design, the Engineer **and the Department** may require additional testing or a new test section, at no additional cost to the Department.
6. *Spoils*: During the course of soil-cement stabilization, return/spoil material shall not be dumped into or otherwise be allowed to enter the soil-cement column. The Contractor shall develop a spoil containment system that allows the channeling of the spoils to the temporary holding pit in such a direction and manner as to keep the spoils away from the site perimeter, and out of the traveled paths. Soil-cement return and spoil material shall be piped or channeled to holding ponds or other retention structures within the work area. The Contractor shall remove all excess grout and grout mixed soil generated from ground improvement activities from the construction site in accordance with the approved DSM Installation Plan.

The Contractor shall take all necessary precautions and implement measures to prevent any soil-cement return, other spoil material or stockpiled materials from entering storm drain structures, drainage courses, other utility lines, or from leaving the site via surface runoff. The Contractor shall prevent soil-cement return, fluid, ponded spoil material, or stockpiled solidified materials from migrating into any water body. In the event soil-cement return, spoil material or stockpiled materials enter storm drain structures, drainage courses, or other utilities, including, but not limited to, surface water bodies beyond site limits of soil-cement mixing operations, the Contractor shall collect and remove all of these materials, and perform all other required/necessary remediation that may be directed by the Engineer **or the Department** or responsible environmental agency, at no additional cost or schedule impact to the Department. The Contractor shall conduct all soil-cement operations to conform to sedimentation and turbidity control requirements of federal, state, and local agencies having jurisdiction over the work.

7. *Delays*: The installation of each DSM-SCC column shall be continuous without interruption. If an interruption of more than two hour occurs, the DSM-SCC shall be remixed for the entire column height using fresh cement grout as though there had not been any cement grout installed, or the column may be abandoned, at no cost or schedule impact to the Department. The Contractor shall install additional columns if the interrupted columns cannot be acceptably remixed.



## EXHIBIT 5 - SPECIAL PROVISIONS

8. *Instability:* Soil-cement column which exhibits partial or total instability at any time, or collapses as a result of mechanical failure of any equipment; inadequacy of cement, water supplies, cement grout; improper drilling, injection or mixing procedures; or other cause, the Contractor shall halt DSM-SCC construction and backfill to ground surface with cement grout. After the backfill has attained sufficient strength to stabilize the ground, complete the required installation by redrilling from ground surface, at no additional expense to the Department. The Engineer will evaluate the potential impacts of the instability and may require one or more additional redrilled columns at overlapping or adjacent locations as determined by the Engineer **or the Department**, and at no additional expense to the Department.
9. *Daily Quality Control Report:* The Contractor shall submit a Daily Quality Control Report for each day that DSM-SCC work is performed. The log shall contain as a minimum the information listed in Section 3.0. The report shall be delivered to the Engineer **and the Department** by the end of the next working day following the report date.
10. *Protective Covers:* Immediately after completing a soil-cement column, the Contractor shall install protective covers to prevent persons from falling or stepping into the unhardened soil-cement column.

**7.3 DSM-LCC Soil-Binder Mixing:** Soil shall be broken up with the mixing tool. As the mixing tool is raised the binder material (i.e. lime-cement or cement) is injected using air pressure. The binder-soil mixture shall achieve an average unconfined compressive strength in 28 days as indicated in the plans. Soil mixing shall be performed with the following minimum requirements:

1. *Binder Injection:* The binder (i.e. lime-cement or cement) volume flow rate per vertical foot of DSM-LCC shall be in accordance with the requirements of the design mix established during the test section. Injection rates falling 10 percent below this requirement, shall require the DSM-LCC to be remixed and additional binder injected (at the design rate) to a depth at least three feet below the deficient zone, at no additional cost to the Department.
2. *Rotation Speeds:* The mixing tool rotational speeds (RPM) and the penetration/withdrawal rates shall be in accordance with the parameters established during the test section(s). If these parameters are varied by more than 15 percent from those determined during the test section(s), the DSM-LCC section shall be remixed using the design binder volume flow rate to a depth of at least three feet below the deficient zone, at no additional cost to the Department.
3. *On-Board Computer:* The preset data in the on-board computer shall be verified for each column as correct and adjusted if necessary. The operator shall monitor and adjust as necessary during DSM column installation the feeding of material, the injection air pressure, and the rates of rotation and rise.
4. *Changes in Binder Mix Design:* The Contractor may request that the established mixing parameters be modified during the production DSM-LCC installation. To verify acceptable results for the modified parameters, the Engineer **or the Department** may require additional testing or a new test section, at no additional cost to the Department.
5. *Delays:* The installation of each DSM-LCC column shall be continuous without interruption. If an interruption of more than two hours occurs, the DSM-LCC shall be remixed for the entire column height using design binder rates as though there had not been any binder installed, or the column may be abandoned, at no cost or schedule impact to the Department. The Contractor shall install additional columns if the interrupted columns cannot be acceptably remixed.
6. *Daily Quality Control Report:* The Contractor shall submit a Daily Quality Control Report for each day that DSM-LCC work is performed. The log shall contain as a minimum the information listed in Section 3.0. The report shall be delivered to the Engineer **and the Department** by the end of the next working day following the report date.

**7.4 DSM Column Construction Tolerances:**

1. *Horizontal Alignment:* The location of the DSM column shown in the Plans shall be accurately staked by a licensed surveyor before beginning installation. The horizontal alignment of DSM columns with group column spacing (GCS) shall be within 4 inches of the planned DSM top location. The horizontal alignment of DSM columns with block column spacing (BCS) shall be within 20 percent of the DSM column diameter, not to less than four inches, of the planned DSM top location in order to obtain sufficient DSM column overlap.
2. *Vertical Alignment:* The equipment operator shall control vertical alignment of the equipment and constructed DSM column. Two measures of verticality shall be monitored, longitudinal and transverse to the DSM column alignment. The DSM column shall be installed at an inclination that deviates no more than 1:100 (horizontal to vertical).
3. *DSM Column Lengths:* The tops of the DSM columns shall begin at the ground surface. The top of DSM column elevations shown in the plans are approximate. Natural soils above the water table, at the completion of DSM installation, shall have been treated to produce the full column design strengths up to within 3 feet of the ground surface. If the top of the DSM columns is being constructed within a surcharge or berm, the top of DSM column elevations shown in the plans shall be used.

The bottom of DSM columns shall extend to the line and grades shown in the plans. The DSM column bottom elevations indicated in the Plans provide the minimum required penetration of the DSM columns. The Engineer and/or the Department may require the Contractor to shorten or deepen the bottom of DSM columns indicated in the plans.

4. *DSM-LCC Width:* When DSM columns are constructed using group column spacing (GCS) the DSM column diameter shown in the plans shall be the minimum required diameter. The diameter of DSM columns constructed using block column spacing (BCS) may vary to accommodate variations in the Contractor's equipment dimensions, provided that the plan area of ground improvement does not exceed the dimensions shown in the Plans more than six inches and is approved by the Engineer and the Department.

**7.5 Unforeseen Conditions and Corrective Remediation:** Unforeseen conditions that result in deficient DSM column construction shall be remediated by the DSM Contractor at no additional cost to the Department. DSM column construction deficiencies and how they were addressed shall be noted in the DSM Daily Production Control Report and Installation Log. DSM column deficiencies that result from changes in rotation speeds of mixing tools, rate of penetration/withdrawal of mixing tools, changes in the rate of grout/binder injection, delays, or changes in binder mix shall be corrected as indicated in subsections 7.2 and 7.3 for DSM-SCC mixing and DSM-LCC mixing, respectively.

If unforeseen conditions result in DSM column interruptions that do not meet the DSM construction requirements (subsections 7.2 or 7.3), the DSM column installation shall be re-drilled a minimum of 1 foot below the elevation of the interruption and the DSM column construction restarted.

When interruption of the installation process occurs because of unknown obstructions or a very dense layer above the planned tip elevation, the Contractor shall document the interruption on the DSM Daily Production Control Report and Installation Log and notify the Engineer and the Department in writing by the end of that day of such encounter and shall provide all pertinent information relating to DSM column identification, plan location coordinates, depth, and expected extent of the obstruction. The Contractor shall be prepared to penetrate very dense layers by first removing mixing tools from the excavation and then using auger drilling equipment or other approved methods to allow the installation of the DSM column. When unknown obstructions are encountered, the Contractor shall submit a proposal to the Engineer and the Department for review that delineates the Contractor's proposed means and methods to overcome the unknown obstruction, including equipment and labor time estimated for this operation. Such construction to remove an unanticipated obstruction shall only be performed with the written authorization

## EXHIBIT 5 - SPECIAL PROVISIONS

of the Engineer **and the Department**. When the obstruction cannot be penetrated or removed, the DSM column shall be completed to the maximum depth penetrated. The need for an alternate design or remedial construction shall then be determined by the Engineer **and the Department**.

Deficient DSM columns due to out of tolerances (subsection 7.4) or not in compliance with DSM construction acceptance (subsection 7.6) will require that the DSM Contractor to submit proposed remedial measures to the Engineer **and the Department** for review and approval. Remedial plans shall show the location, depth, construction exceptions requested, and proposed method of remediating the deficient DSM ground improved areas. Remedial plans, if accepted, shall be at no cost or schedule impact to the Department.

**7.6 DSM Construction Acceptance:** The QC reporting (logs), testing, and acceptance procedures for the DSM test section(s) and production DSM columns shall be the same. QC testing methods are described in Section 8.0 and Acceptance Criteria are provided in Section 11.0.

**8.0 DSM Testing Methods.** QC testing of DSM columns consists of using field and laboratory testing techniques to evaluate the integrity, consistency, and strength of the DSM column for the entire full depth of soil improvement. QC testing methods that will be used include probe testing (subsection 8.1), soil borings and undisturbed sampling with Shelby tubes (subsection 8.2), and coring and sampling (subsection 8.3). Samples obtained by undisturbed sampling with Shelby Tubes or coring shall have samples tested for compressive strength testing (subsection 8.4). DSM testing shall be conducted in accordance with the SCDOT Geotechnical Design Manual, version 1.1 (2010), or later.

The results of the compressive testing shall be used to develop correlations for use with probe testing and therefore improve the reliability of the probe testing results. This will be accomplished by performing continuous undisturbed Shelby tube sampling and/or coring in one quadrant of the DSM column and probe testing in another quadrant of the same DSM column.

Any of the DSM testing methods presented may be used on production DSM columns to evaluate deficiencies based on construction records or field observations.

### **8.1 Probe testing:**

1. Probe testing shall be conducted using the seismic cone penetrometer test with pore pressure measurements (SCPTu). The SCPTu testing results (i.e. tip resistance, friction sleeve resistance, pore pressure, and shear wave velocity vs. depth of penetration) shall be provided graphically and in electronic file format to the Engineer **and the Department**.
2. Probe testing shall be performed in the presence of the Engineer **and the Department**, unless otherwise directed. The Contractor shall notify the Engineer at least seven calendar days in advance and confirmed 2-days (48 hours) prior to beginning SCPTu operations.
3. The SCPTu testing shall be conducted in accordance with the SCDOT Geotechnical Design Manual.
4. Probe testing shall be performed after the soil-binder mixture has hardened sufficiently, but before it has cured to the extent to cause refusal to the SCPTu equipment.
5. Unless directed otherwise by the Engineer **and the Department**, probe tests shall be performed along an essentially vertical alignment located within one of the quadrants of the DSM column and shall include inclinometer measurements that confirm the verticality of the SCPTu test data such that the entire probe test is determined to have been advanced within the DSM column. The SCPTu shall be taken at a distance of 2/5 the DSM column radius from the center of the DSM column.
6. If seismic cone shear wave testing results are inconclusive, the SCPTu may be discontinued and cone penetrometer test with pore pressure measurements (CPTu) may be used with written approval from the Engineer **and the Department**.

## EXHIBIT 5 - SPECIAL PROVISIONS

7. The CPT testing equipment shall be sized to allow full penetration and testing to the depth of the planned test DSM column plus 10 feet.
8. If standard full-size CPT truck equipment (i.e. 20-30 ton reaction truck) is not capable of testing to the desired depths, the Contractor shall conduct SPT testing in accordance with the SCDOT Geotechnical Design Manual, at no additional cost to the Department. SPT shall be conducted on a maximum five foot center interval to the depth of the planned test DSM column plus 10 feet.
9. All probe test holes shall be filled with cement grout that will obtain 28-day strength equal to or greater than the DSM column compressive design strength required in the plans.

### **8.2 Soil Borings and Undisturbed Sampling:**

1. Soil borings and undisturbed Shelby tube sampling shall be performed in the presence of the Engineer and the Department, unless otherwise directed. The Contractor shall notify the Engineer and the Department at least seven calendar days in advance and confirmed 2-days (48 hours) prior to beginning soil boring operations.
2. Soil borings and sampling shall be conducted in accordance with the SCDOT Geotechnical Design Manual.
3. High quality undisturbed sampling shall be obtained after the soil-binder mixture has hardened sufficiently to a minimum compressive strength of 3 psi (430 psf) but not greater than 55 psi (7,900 psf).
4. Unless directed otherwise by the Engineer and the Department, soil borings shall be obtained along an essentially vertical alignment located within one of the quadrants of the DSM column. The soil boring shall be taken at a distance of 2/5 the DSM column radius from the center of the DSM column.
5. Sampling shall be conducted using a thin wall Shelby tube sampler and/or pitcher barrel sampler in accordance with the SCDOT Geotechnical Design Manual.
6. Upon Shelby tube retrieval, the samples shall be logged visually without extraction of the samples from the Shelby tube and sealed to prevent loss of moisture during transport.
7. Undisturbed samples shall be transported by the Contractor to the independent AASHTO certified materials testing laboratory where the samples will be extracted, stored, and tested.
8. Upon extraction of the samples at the independent materials testing laboratory, the samples shall be logged and documented by taking pictures. The percent recovery per Shelby tube sampler based on the sampler penetration shall be documented. Samples shall be selected for testing and submitted to the Engineer and the Department for approval. Samples shall be stored and cured in accordance with ASTM D 1632 until the test date.
9. All soil boring holes shall be filled with cement grout that will obtain 28-day strength equal to or greater than the DSM column compressive design strength required in the plans.

### **8.3 Coring and Sampling:**

1. Coring/sampling shall be performed in the presence of the Engineer, unless otherwise directed. The Contractor shall notify the Engineer and the Department at least seven calendar days in advance and confirmed 2-days (48 hours) prior to beginning coring/sampling operations.
2. High quality continuous core sampling shall be obtained after the soil-binder mixture has hardened sufficiently to approximately a compressive strength of 42 psi (6,050 psf).
3. Unless directed otherwise by the Engineer and the Department, core runs shall be obtained along an essentially vertical alignment located within one of the quadrants of the DSM column. The core run shall be taken at a distance of 2/5 the DSM column radius from the center of the DSM column.

## EXHIBIT 5 - SPECIAL PROVISIONS

4. Coring shall be conducted using double or triple tube samplers to obtain samples of 2.5 inches in diameter or greater. Triple tube core barrel may be required by the Engineer **or the Department**, at no additional cost to the Department, if the sample quality of the double tube core barrel is not providing high quality samples suitable for compression strength testing.
5. Each core run shall be at least four feet in length and contain at least four acceptable test specimens. Three samples per core run are required to perform compressive strength testing with one reserve sample.
6. A minimum core run recovery of 85 percent for each 4-foot-long core run shall be achieved. During coring, the elevation of the bottom of the holes shall be measured after each core run in order that the core recovery for each run can be calculated. The core recovery and RQD for every core run shall be reported in the logs. Additional cores may be required, at no additional cost to the Department, if core run recovery is less than 85 percent.
7. Upon retrieval, the samples shall be field logged and documented by taking pictures. Samples shall be selected for testing and submitted to the Engineer **and the Department** for approval.
8. Following logging and test specimen selection, the entire full-depth sample, including the designated test specimens, shall be immediately sealed in plastic wrap to prevent drying, placed in suitable core boxes, and transported to the materials testing laboratory by the Contractor within 24 hours.
9. All core holes shall be filled with cement grout that will obtain 28-day strength equal to or greater than the DSM column compressive design strength required in the plans.
10. Cores shall be transported by the Contractor to the independent AASHTO certified materials testing laboratory where the samples will be stored and tested. Samples shall be stored and cured in accordance with ASTM D 1632 until the test date.

### **8.4 Strength Testing of Samples:**

1. All samples shall be kept out of sunlight at 70 degrees F and under fully humid conditions throughout storage and curing that prevents loss of sample moisture via evaporation.
2. Samples suitable for strength testing shall have a height to diameter ratio of 2.0.
3. Strength testing shall be performed by unconfined compression testing method per AASHTO specification T-208-96, but with strain rate not faster than 0.5% per minute, but not slower than 0.25%/minute, and with test equipment set up to record in both tabular and graphical form the axial stress and strain constant increments of axial strain no larger than every 0.05% axial strain. The Contractor will be permitted to perform UU Triaxial Compressive Tests, with approval of the Engineer **and the Department**, in lieu of performing unconfined compressive strength test, at no additional cost to the Department.
4. Compressive strength testing results shall be transmitted to the Engineer **and the Department** for review within 24 hours of the compression test completion. The remaining portions of the full-depth samples that are not tested shall be retained by the Contractor, until completion and acceptance of the work, for possible inspection and confirmation testing by the Engineer **or the Department**.

### **9.0 DSM Test Section and QC Testing Program.**

The QC testing program for each test section will be submitted to the Engineer **and the Department** within 5 days after test section DSM column installation and shall be based on the results of DSM pre-production laboratory testing, early probe testing (3 and 5 days after column installation), and review of samples obtained for strength testing. The approved compressive strength testing program (i.e. Plan location, sample depth, and elapsed time after construction to perform compressive testing) shall then be submitted to the Contractor's independent AASHTO certified laboratory testing firm.

## EXHIBIT 5 - SPECIAL PROVISIONS

Unless otherwise directed by the Engineer **and the Department**, a minimum of four Plan locations shall have QC testing, per test section. QC testing at each Plan location shall consist of full-depth continuous soil borings or corings per subsections 8.2 and 8.3, respectively. Soil boring or coring sampling shall be performed in one DSM column quadrant, while probe testing, per subsection 8.1, shall be performed in another DSM column quadrant. A minimum of six samples at each QC testing Plan location shall be selected by the Contractor and approved by the Engineer **and the Department** for compressive strength testing. Compressive strength testing of cores (subsection 8.4) and probe testing (Section 8.1) at QC testing Plan locations shall be conducted at 7, 14, 28, and 56 days after test DSM column installation. The results of the compressive testing shall be used to develop correlations for use with probe testing and therefore improve the reliability of the probe testing results. A test DSM column compressive strength testing report shall be compiled by the independent testing company and submitted to the Contractor, the Engineer, **and the Department**. The compressive strength testing report shall document the soil boring/core sampling and compressive strength testing conducted on the cores.

In addition to probe testing conducted at QC testing Plan locations, full depth probe testing shall be conducted at two separate plan locations within the test section in separate DSM column quadrants at 3, 7, 14 and 28 days after test DSM column installation. A probe testing report shall be compiled of all testing results in accordance with Section 7.2.

The Contractor shall use the results of the test sections to establish the DSM production construction criteria. The DSM production construction criteria shall be developed to produce DSM columns that meet the Acceptance Criteria in Section 11.0. DSM production construction criteria for DSM columns shall include as a minimum, the following criteria.

### ***DSM-SCC Production Construction Criteria:***

1. Grout mix design including ratios of all materials mixed to form the grout.
2. Grout specific gravity.
3. Grout injection rates.
4. Type of equipment.
5. Mixing tool penetration and withdrawal rates.
6. Mixing tool rotation speed.
7. Construction procedures and techniques.

### ***DSM-LCC Production Criteria:***

1. Binder mix design including ratios of all materials (i.e. lime-cement or cement) mixed to form the soil-binder material.
2. Lime-cement injection rates.
3. Type of equipment.
4. Mixing tool penetration and withdrawal rates.
5. Mixing tool rotation speed.
6. Construction procedures and techniques.

The Contractor shall use the results of the test sections to establish the Production Quality Control (QC) testing program per Section 10.0.

Construction of production DSM columns may begin only after written acceptance by the Engineer **and the Department** of the "DSM Production Construction Criteria" and the "Production Quality Control (QC) Testing Program." If construction criteria, construction procedures, equipment, new mobilizations, or changes in personnel are made, following acceptance of the test sections, the Department reserves the right to require the Contractor to construct a new test section at no additional cost to the Department.

### **10.0 Production QC Testing Program.**

The Production QC Testing program shall be developed by the Contractor and approved by the Engineer **and the Department**. The Production QC Testing program will be required to include probe testing per

## EXHIBIT 5 - SPECIAL PROVISIONS

subsection 8.1 and strength testing of samples per subsection 8.4. The following minimum requirements shall be used to developing the Production QC Testing Program:

### **DSM QC Testing Program Minimum Requirements:**

1. The Production QC Testing Program goal is to establish continuity/integrity of the columns and to obtain a measure of their strength. This is accomplished by using the QC Testing to evaluate if the DSM ground improvement is meeting the Acceptance Criteria in Section 11.0.
2. Provided that acceptable correlations can be developed between probe testing and compression strength testing, QC probe testing per subsection 8.1 shall be performed at a minimum frequency of 5 percent of production columns (1:20) but not less than 1 QC probe test for every 200 cubic yards of DSM stabilized volume.
3. One Soil boring/Coring full depth of DSM columns plus 10 feet with a minimum of one strength test per 5 feet of penetration of stabilized soil (Section 8.0) shall be obtained adjacent to probe testing (adjacent DSM quadrant) at a minimum frequency of 0.5 percent of production columns (1:200) but not less than 1 QC probe test for every 2,000 cubic yards of DSM stabilized volume.
4. If acceptable correlations cannot be developed between probe testing and compression strength testing, one Soil boring/Coring full depth of DSM columns plus 10 feet with a minimum of one strength test per 5 feet of penetration of stabilized soil (Section 8.0) shall be obtained adjacent to probe testing (adjacent DSM quadrant) at a minimum frequency of 1.0 percent of production columns (1:100) but not less than 1 QC probe test for every 1,000 cubic yards of DSM stabilized volume.
5. The QC Testing program shall define the limits of the production DSM testing based on the number of rigs operating, anticipated production schedule, and the minimum QC testing criteria defined above.
6. The QC Testing program shall include provisions for revising QC testing frequency as a result of failing DSM Acceptance Criteria, changes in construction criteria, construction procedures, equipment changes, new mobilizations, or changes in personnel that are made following acceptance of the test sections.
7. The Department reserves the right to require the Contractor to perform additional QC testing after review of the daily Quality Control Report/Log of the production DSM columns and/or review of QC Testing results. Although coring and conducting compressive strength testing of cores (Section 7.1) is not intended to be a routine QC testing method, the Engineer and the Department reserves the right to use this QC testing method based on the results of the probe testing at anytime.
8. The Contractor shall determine the time interval between DSM installation and QC testing. QC testing shall be performed on columns cured for a minimum of 3 days but no longer than 28 days, or as directed by the Engineer and the Department.
9. Only probe testing equipment and methods that have been calibrated during the test section shall be used for QC testing. If production DSM columns are being installed differently from the test section DSM column installation, a calibration of the probe testing with coring and compression testing shall be required unless approved otherwise by the Engineer and the Department.

**11.0 Acceptance Criteria.** Determination that the DSM columns meet the Acceptance Criteria (for DSM construction, DSM column continuity, and DSM compressive strength requirements) shall be evaluated solely by the Engineer and the Department based on a review of daily Quality Control Report/Log of the production DSM columns and QC testing results conducted by an independent testing company.

**11.1 DSM Construction Acceptance Criteria:** DSM columns shall be considered acceptable by the Department when daily Quality Control Report/Log of the production DSM columns and any remediation reports indicate that the:

1. Location of the top of the columns has been verified to be within design tolerances
2. Penetration of the column has been verified as correct by the Engineer.
3. Continuously recorded injection quantity of cement grout for DSM-SCC and binder (lime-cement or cement) for DSM-LCC columns has been verified to be within 10% of the design (preset) value

## EXHIBIT 5 - SPECIAL PROVISIONS

established for the production DSM construction criteria based on the results of approved production DSM construction design criteria.

**11.2 Evaluation of DSM Column Continuity:** Lumps of unimproved soils shall not amount to more than 15 percent of the total volume of any 4-foot section of continuous full-depth evaluation by either conducting continuous probe testing, soil borings, or coring. Any individual or aggregation of lumps of unimproved soil shall not be larger than 6 inches in greatest dimension. For evaluating the volume of unimproved lumps of soil, all of the unrecovered samples shall be assumed to be unimproved soil. In addition, within a sample, the sum length of unmixed or poorly mixed soil regions or lumps that extend entirely across or a portion thereof the diameter of the sample will be considered unimproved.

**11.3 Design Compressive Strength Acceptance:** Unless directed otherwise by the Engineer and the Department, all DSM QC compressive strength test results shall indicate a minimum of 60 percent of the design compressive strength at 5 days or less. Failure to meet this criterion shall deem the DSM column to be in non-conformance of the DSM compressive strength acceptance criterion. The DSM column shall be retested (same DSM column, different quadrant) at 28 days where the average QC strength testing shall indicate 100 percent or more of the compressive design strength with no sample testing less than 85 percent of the compressive design strength. Failure to meet the 28 day QC strength testing criterion shall deem the DSM column to be in non-conformance of the DSM compressive strength acceptance criteria. The Contractor may elect to conduct additional QC strength testing in excess of 28 days, with approval of the Engineer and the Department, at no additional cost to the Department. Unless otherwise determined by the Engineer and the Department, the extent of the non-conformance QC test area shall be considered to include all DSM constructed during all rig shifts that occurred after construction when passing tests were achieved. Non-conforming DSM QC test areas shall be remedied by the Contractor by conducting the following procedures.

The Contractor may conduct two or more additional QC probe tests (locations designated by the Contractor and approved by the Engineer and the Department) to better define the limits of the non-conformance and submit the results of those tests for review by the Engineer and the Department at no additional cost to the Department. If a minimum of 60 percent of the design strength has been achieved at 5 days or less, the Engineer shall evaluate the DSM construction documentation to determine which DSM columns are in conformance. If compressive strength criteria are achieved, with approval of the Engineer, all or a portion of the production DSM QC testing area may be approved provided that any deficient production DSM columns are remedied by one of the following two options. Failure to meet the required design strength of the additional DSM QC testing shall require that the DSM QC test area be remedied by one of the following options as approved by the Engineer and the Department.

1. Provide 2 or more additional QC tests (locations designated by the Engineer or the Department) within the DSM QC test area which demonstrate that at 28 days, the average QC strength testing is 100 percent or more of the compressive design strength with no sample testing less than 85 percent of the compressive design strength.
2. Re-drilling all or a portion of the nonconforming DSM QC test area and mixing additional cement grout for DSM-SCC columns or binder material (lime-cement or cement) for DSM-LCC, while raising the mixing tool. The Contractor shall submit a proposed plan for remixing or repair of failed sections for review and approval by the Engineer and the Department. Repair work of failed DSM columns shall be performed at no additional cost to the Department. Changing grout or binder quantities may require additional QC testing to calibrate QC probe testing. After reconstruction of the production DSM-LCC testing section, the affected DSM-LCC testing section will be subject to the compressive strength acceptance criteria as defined in this section.

**12.0 As-Built Plans.** Following completion of the production DSM column construction, the Contractor shall furnish to the Engineer and the Department a set of as-built plans detailing the locations of the DSM columns in terms of project coordinates, top and bottom elevations, QC compressive strength testing results, and any other dimensions of the DSM columns that are pertinent to the project.



**EXHIBIT 5 - SPECIAL PROVISIONS**

**13.0 Measurement and Payment.** DSM constructed using group columns spacing (GCS) will be measured per linear foot of DSM column constructed and then accepted by the Engineer and the Department. DSM constructed using block column spacing (BCS) will be measured by the total neat-line ground improved volume (in cubic yards) accepted by the Engineer and the Department, where the neat-line is the rectangular plan area of the required ground improvement zone times the specified improvement depth. Material located outside of the tolerances specified will not be measured. Material used to remix an area found to be unacceptable to the Engineer or the Department will not be measured. The test section(s) will not be measured, and is considered incidental to the production DSM ground improvement.

Payment will be made at the unit contract price per linear feet for DSM constructed using group columns spacing (GCS) and per cubic yard for DSM constructed using block column spacing (BCS). Payment for DSM columns will be full pay to perform the work as specified including construction and testing of test sections, QC testing, construction and removal of surcharges and berms, handling and hauling of excavated spoils, and site cleanup.

**Payment will be made under:**

Item No.	Pay Item	Pay Unit
2051201	Ground Improvement (Deep Soil Mixing Soil-Cement Columns - BCS)	CY
2051202	Ground Improvement (Deep Soil Mixing Soil-Cement Columns - GCS)	LF
2051203	Ground Improvement (Deep Soil Mixing Lime-Cement Columns- BCS)	CY
2051204	Ground Improvement (Deep Soil Mixing Lime-Cement Columns- GCS)	LF

**(75) DIVISION 200: GEOGRID SOIL REINFORCEMENT**

June 17, 2010

Division 200 is expanded as follows:

**1.0 Description.** This work shall consist of furnishing primary geogrid soil reinforcement in accordance with these specifications.

**2.0 Reference Documents.** The latest edition of the test standards shall be used. Substitution of standards will require the prior written approval of the Research and Materials Engineer.

**3.0 Material.** Geogrid design requirements shall be as shown in the plans and specified in the design drawings. Geogrid soil reinforcement shall consist of a regular network of integrally connected polymer tensile elements with aperture geometry sufficient to permit significant mechanical interlock with the surrounding soil, aggregate, or other material. The structure of the geogrid reinforcements shall be dimensionally stable and able to retain its geometry under construction stresses and shall have high resistance to damage during construction, to ultraviolet degradation, and to all forms of chemical and biological degradation encountered in the soil being reinforced.

**EXHIBIT 5 - SPECIAL PROVISIONS**

**3.1 Primary Reinforcement.** Primary geogrids shall provide the following minimum allowable long-term reinforcement tension load,  $T_{al}$ .

Property	Method	P1 <sup>(3)</sup>	P2	P3	P4	P5	P6	P7
Allowable Long-term Tension Load, $T_{al}$ <sup>(1)</sup> <sup>(2)</sup> (lb/ft)	FHWA NHI-00-043	450	800	1450	2300	3000	3600	4000

<sup>(1)</sup> Minimum  $T_{al}$  in machine direction unless otherwise specified

<sup>(2)</sup> Minimum pullout friction factor  $F^*=C_i \tan \Phi$ , where soil interaction coefficient,  $C_i \geq 0.6$

<sup>(3)</sup> Biaxial Geogrid – Minimum  $T_{al}$  in strong direction, minimum  $T_{al}$  in weak direction is 360 lb/ft.

where  $T_{al} = \frac{T_{ult}}{RF}$  and  $RF = RF_{CR} \times RF_D \times RF_{ID}$  and  $RF \geq 3.0$

**3.2 Secondary Reinforcement.** Secondary reinforcement, Type S1, shall meet the following minimum average physical properties:

Property	Method	Value
1. Tensile Strength <sup>(1)</sup>		
a. 5% strain, lb/ft <sup>(2)</sup>	ASTM D 4595	800
b. Ultimate Tensile Strength, $T_{ult}$ (lb/ft)	ASTM D 4595	1400
c. Allowable Long-Term Strength, $T_{al}$ (lb/ft)	FHWA NHI-00-043	200
2. Apparent Opening Size	ASTM D 4751	>50, <80

NOTE: <sup>(1)</sup> In direction perpendicular to the slope face.

<sup>(2)</sup> No offset allowance is permitted.

**4.0 Certification.** Prior to construction the Contractor shall submit to the Geotechnical Design Engineer (GDE) and the Department a Certification Package prepared by the geogrid reinforcement manufacturer. The Contractor shall allow 15 calendar days from the day the submittals are received by the GDE for review and acceptance. The Certification shall state that the furnished geogrid soil reinforcement is in full compliance with the design requirements as stated in this specification and the design drawings and is fit for use in long-term critical soil reinforcement applications. The submittal shall certify the following values for each geogrid soil reinforcement used on the project:

1. The allowable long-term tensile load,  $T_{al}$ , for geogrid soil reinforcements
2. The ultimate tensile strength,  $T_{ULT}$ , (MARV) for geogrid soil reinforcements.
3. The geogrid's pullout coefficients ( $F^*$ ,  $\alpha$ )

The manufacturer shall also provide written certification that the material is capable of withstanding direct exposure to sunlight for 120 days with no measurable deterioration as measured per ASTM D 4355. The Contractor's submittal package shall include, but not be limited to, actual test results for tension, creep, durability, construction damage, joint strength, pullout and quality control. A person having the legal authority to bond the manufacturer shall attest to the certificate. Any tests required shall be performed at no additional cost to the Department. If in the opinion of the GDE or the Department, the required documentation is not provided for individual reduction factors (RF) or pullout coefficients ( $F^*$ ,  $\alpha$ ), default values for these design parameters shall be used in accordance with this specification.

The submittal shall certify the following values and document for each geogrid soil reinforcement used on the project:

**4.1 Ultimate Tensile Strength ( $T_{ult}$ ):** The ultimate tensile strength,  $T_{ult}$ , shall be determined from wide width tensile tests (ASTM D 4595) or rib tensile test for geogrids (ASTM D 6637). Geogrid samples

## EXHIBIT 5 - SPECIAL PROVISIONS

tested in accordance with ASTM D 4595 shall have at least two geogrid apertures and a minimum gage length of 4 inches. All geogrid strength tests (ASTM D 4595 and ASTM D 6637) shall be conducted at a strain rate of 10% per minute based on actual gage length necessary to meet the testing sample dimension requirements. Laboratory test results documenting the ultimate tensile strength,  $T_{ult}$ , in the reinforcement direction shall be based on the minimum average roll values (MARV) for the product.

**4.2 Allowable Long-term Tensile Load ( $T_{al}$ ):** The allowable tensile load,  $T_{al}$ , per unit width of geosynthetic soil reinforcement in accordance to the backfill type used shall be computed as follows:

$$T_{al} = \frac{T_{ult}}{RF}$$

**4.3 Reduction Factor (RF):** The total reduction factor, RF, is the combined reduction factor for long-term degradation due to installation damage, creep, and durability. The total reduction factor, RF, shall be defined as follows:

$$RF = RF_{ID} \times RF_{CR} \times RF_D \geq 3.0$$

The individual reduction factors shall be documented in accordance with the site conditions, design calculations, and specifications. When sufficient documentation is not provided for individual reduction factors,  $RF_{ID}$ ,  $RF_{CR}$ , and  $RF_D$ , a reduction factor RF of 7.0 shall be used. The reinforcement manufacturer shall certify and document the individual reduction factors as follows:

**4.3.1 Installation Damage Reduction Factor ( $RF_{ID}$ ):** The reduction factor for installation damage,  $RF_{ID}$ , shall be documented by field and laboratory test results and literature review, as described in ASTM D 5818 for the reinforced backfill specified or for more severe soils. Samples subjected to installation damage shall be tested for tensile strength and deformation characteristics in accordance with ASTM D 4595 (modified for geogrid testing). Recommended values for reduction factors for installation damage ( $RF_{ID}$ ) for various soils shall also be documented. The minimum installation damage reduction factor,  $RF_{ID}$ , shall be 1.1, regardless of product specific test results.

**4.3.2 Creep Reduction Factor ( $RF_{CR}$ ):** Laboratory test results documenting creep performance over a range of load levels, for a minimum duration of 10,000 hours based on tension creep test (ASTM D 5262) shall be required. Creep test samples shall be of sufficient width to be representative of overall product creep response (fiber creep testing will not be accepted).

The creep-limiting strength,  $T_l$ , shall be based on extrapolating the 10,000 hours (or longer duration) tension creep tests to a 75-year design life, unless a 100-year design life is specified in the plans. The creep extrapolation method shall be based on methods described in FHWA NHI-00-43, "*Mechanically Stabilized Earth Walls and Reinforced Soil Slopes*" - Appendix "B". Laboratory test results and extrapolation methodology shall be documented.

The reduction factor for creep,  $RF_{CR}$ , is defined as the ratio of the average lot specific ultimate tensile strength,  $T_{ULTLOT}$ , to the creep-limiting strength,  $T_l$ . The average lot specific ultimate tensile strength,  $T_{ULTLOT}$ , for the lot of material used for creep testing,  $T_{ULTLOT}$ , shall be determined from wide width tensile test, ASTM D 4595, (modified for geogrid testing).

**4.3.3 Durability Reduction Factor ( $RF_D$ ):** The total reduction factor for durability,  $RF_D$ , shall be defined as the combined effects of chemical and biological degradation. Laboratory test results, extrapolation techniques, and a comprehensive literature review shall document the reduction factor for durability for all material components in accordance with FHWA NHI-00-044, "*Corrosion/Degradation of Soil Reinforcements for Mechanically Stabilized Earth Walls and Reinforced Soil Slopes*". The minimum durability reduction factor,  $RF_D$ , shall be 1.1, regardless of product specific test results.

**4.4 Soil Reinforcement Pullout Coefficients ( $F^*$ ,  $\alpha$ ):** The Certification Package shall document the pullout coefficients ( $F^*$ ,  $\alpha$ ) meet or exceed the required coefficients necessary to obtain the  $T_{al}$  provided above.

**EXHIBIT 5 - SPECIAL PROVISIONS**

The pullout friction factor,  $F^*$ , and the scale effect correction factor,  $\alpha$ , shall be documented by laboratory testing from pullout tests. Pullout testing shall be conducted for site-specific materials or for materials representative of the reinforced backfill at confining pressures ranging from 2 to 10 psi. When laboratory tests are used from representative soils, the representative soils shall be documented by providing the soil's angle of internal friction, gradation, and coefficient of uniformity ( $C_u = D_{60}/D_{10}$ ). Recommended pullout coefficients for various soil types shall also be documented. The pullout coefficients shall be determined by using the quick effective stress pullout tests ("Measuring Geosynthetic Pullout Resistance in Soil" per ASTM D 6706) and through-the-junction creep testing of the geogrid per ASTM D 5262. The soil interaction coefficient,  $C_i$ , shall be documented when computing the pullout friction factor,  $F^*$ . When sufficient documentation is not provided for pullout coefficients,  $F^*$  and  $\alpha$ , and the coefficient of uniformity,  $C_u$ , is greater or equal to 4, the default values indicated in this specification can be used. If the coefficient of uniformity of the reinforced backfill is less than 4, laboratory pullout test shall be required to determine pullout friction factor,  $F^*$ , and the default scale effect factor,  $\alpha$ .

**5.0 Manufacturing Quality Control.** The Contractor shall provide to the RCE a manufacturing quality control certificate and conformance testing results for all geosynthetic soil reinforcement delivered to the site. Sampling and conformance testing shall be in accordance with ASTM D 4354. Geosynthetic product acceptance shall be based on ASTM D 4759. Geogrid samples tested in accordance with ASTM D 4595 shall have at least two geogrid apertures and a minimum gage length of 4 inches. All geogrid strength tests (ASTM D 4595 and ASTM D 6637) shall be conducted at a strain rate of 10% per minute based on actual gage length necessary to meet the testing sample dimension requirements. Laboratory test results documenting the ultimate tensile strength,  $T_{ult}$ , in the reinforcement direction shall be based on the minimum average roll values (MARV) for the product. Conformance testing of the applicable index testing shown in Table 5.0 shall be provided for all geosynthetic soil reinforcement. The quality control certificate shall include roll numbers and identification, sampling procedures, and results of the conformance testing with a description of test methods used. The geogrid manufacturer shall have a manufacturing quality control program that includes QC testing no less frequently than each 200,000 sf (20,000sm) of production.

Table 5.0 – Applicable Index Testing

Type	Property	Test Method	Criteria
Polypropylene (PP)	UV Oxidation Resistance	ASTM D 4355	Minimum 70% strength retained after 500 hrs. in weatherometer
	Melt Flow Rate	ASTM D 1238	≤ 12 g/10 min
Polyethylene (HPDE)	UV Oxidation Resistance	ASTM D 4355	Minimum 70% strength retained after 500 hrs. in weatherometer
	Melt Flow Rate	ASTM D 1238	< 0.4 g/10 min
	Specific Gravity	ASTM D 792	1.2 Average
Polyester (PET)	Hydrolysis Resistance	Intrinsic Viscosity Method (ASTM D 4603 and GRI Test Method GG8) with Correlation or Determine Directly Using Gel Permeation Chromatography	Minimum Number Average Molecular Weight of 25,000
	Hydrolysis Resistance	GRI GG7	Maximum Carboxyl End Group (CEG) Content of 30
All Polymers	Survivability	Weight per Unit Area ASTM D 5261	Minimum 270 g/m <sup>2</sup> (7.9 oz/yd <sup>2</sup> )

**EXHIBIT 5 - SPECIAL PROVISIONS**

	% Post Consumer Recycled Material by Weight	Certification of Material Used	Maximum 0%
--	---	--------------------------------	------------

**6.0 Measurement and Payment.** All costs for installing the geogrid soil reinforcement (primary and secondary) is to be included in the amount bid for the pay items below.

Measurement of primary and secondary geogrid soil reinforcement is on a square yard basis and will be computed based on the total area of primary or secondary geogrid soil reinforcement shown in the plans, exclusive of the area of geogrids used in any overlaps. Overlaps and any geogrid waste are an incidental item. The quantity of primary geogrid soil reinforcement (biaxial or uniaxial) shall be paid at the contract unit price for Geogrid Reinforcement.

**Payment will be made under:**

Item No.	Pay Item	Pay Unit
2037000	Geogrid Reinforcement (Uniaxial)	SY
2037010	Geogrid Reinforcement (Biaxial)	SY

**(76) DIVISION 200: GROUND MODIFICATION – VIRBRO STONE COLUMN**

(VIBRO DISPLACEMENT)

January 9, 2013

Division 200 is expanded as follows.

**1.0 DESCRIPTION**

This section presents vibro-displacement requirements for ground modification by stone column (SC) construction at both bridge approaches using the dry bottom feed method. This Special Provision details the technical and quality assurance requirements for furnishing all supervision, labor, material, equipment, and related services necessary to construct all soil improvements by vibro-displacement. The construction work includes subsurface soil improvement by vibro-displacement and delivery and placement of all backfill necessary in the improvement process. Soil improvement by vibro-displacement method shall be provided in the areas shown in the roadway plans and as required by this Special Provision. Ground modification is for mitigation of settlement due to consolidation, settlement due to liquefaction and embankment stability.

The Contractor or Sub-contractor performing the vibro-displacement construction shall be one who can provide a minimum 5 year experience record documenting 15 recent successful projects completed with specific application to these site conditions, ground modification technique, and soil improvement criteria. References asserting this documentation shall be provided upon request. The Contractor must have sufficient production capacity to produce the required work without causing delay to the project.

The Contractor shall layout, and measure the locations for vibro work. Vibro points may be surveyed in or located by measuring offsets from surveyed points (e.g., project stations) using a tape measure.

The Contractor shall notify the Engineer and the Department 48 hours prior to commencement of the vibro operations.

## EXHIBIT 5 - SPECIAL PROVISIONS

The Contractor shall submit plans and shop drawings to the Engineer and the Department for review and approval at least 30 days prior to work beginning, indicating the sequence, spacing, location, and depth of the vibro points to achieve the criteria outlined in this specification and shown in the roadway plans. Any change in the predetermined vibro program necessitated by a change in the subsurface conditions shall be immediately reported and submitted to the Engineer and the Department. Upon completion of the work, the Contractor shall submit a drawing of as-built locations of the stone columns.

### 2.0 MATERIALS

The backfill for vibro-displacement shall consist of hard, durable crushed gravel or crushed stone with a gradation consistent with #57 sized crushed aggregate (meeting ASTM C33 coarse aggregate requirements). Fossiliferous or soft limestone materials shall not be used.

The Contractor shall submit certifications and test reports that indicate the backfill materials meet specified requirements prior to commencing field work.

### 3.0 CONSTRUCTION METHODS

Prior to commencing work, the Contractor shall examine the following: site conditions, drawings, records of existing utilities and other existing subsurface structures, and Geotechnical Reports, including soil boring logs. This data will be made available by the Engineer to help determine vibro-displacement installation conditions.

Data on indicated subsurface conditions is provided solely for convenience of the Contractor. It is expressly understood that the Department, Engineer, or the Engineer's sub-consultants will not be responsible for interpretations or conclusions drawn therefrom by the Contractor. The Department and Engineer expressly encourage the Contractor to perform soil test borings or other subsurface explorations to determine whether the Contractor's proposed ground modification method is capable of installing the specified vibro-displacement stone columns. If the Contractor needs additional test borings and other exploratory operations, they may be conducted at no additional cost to the Department.

The vibro-displacement stone columns shall be constructed prior to bridge foundations. Positive site drainage shall be established prior to construction of the vibro-displacement stone columns. Contractor shall control all spoils generated during vibro-displacement stone column construction and prevent spoils from flowing offsite. Spoils generated by vibro-displacement stone column construction shall be disposed of properly and removed from the site by the Contractor. No additional compensation shall be made for handling spoil.

Vibro-displacement stone columns shall be constructed at the locations shown on the project roadway plans and in accordance with this special provision.

If stone columns are installed through embankment fill that will be later excavated, #57 stone should be used to backfill the portion above the excavation limit. No payment will be made for stone columns installed within areas that are later excavated. The contractor shall be responsible to construct vibro-displacement stone columns to the depths required, and shall use the methods necessary to penetrate to the required depth, including but not limited to pre-augering through stiff and dense layers that may be present, as well as obstructions from existing construction.

The stone columns shall be installed to the minimum required Area Replacement Ratio. The required minimum area replacement ration ( $A_r$ ) achieved at any depth by the vibro-displacement stone columns shall be that which is equivalent to 36-inch diameter stone columns spaced 8 ft. center-to-center (c-c) on a triangular pattern.

The area replacement ratio shall be defined by the following relationships:

$$A_r = \frac{\text{Stone Column Area}}{\text{Area}} \times 100\%$$

## EXHIBIT 5 - SPECIAL PROVISIONS

### Tributary Area

Where: Stone Column Area = Area of circle based on column diameter as defined below.  
Tributary Area =  $0.866 (\text{Column Spacing})^2$  for triangular spacing

Acceptance of the constructed column will be based on the theoretical column diameter determined from the volume of backfill installed and an assumed relative density of compacted washed stone equal to 90%.

The Contractor shall, at all times, protect structures, underground utilities and other construction from damage caused by vibro operations. Damaged material shall be replaced or repaired to the satisfaction of the Engineer and the Department at no additional cost to the Department.

At no time during stone column installation will the use of water be allowed to flush soil cuttings from mitigated zone.

The Contractor shall:

1. Verify the location of existing underground utilities by excavation before starting vibro operations. If utility lines are to remain in place, provide protection from damage during vibro operations.
2. Consult the Engineer and the Department immediately for directions as to procedure if uncharted or incorrectly charted piping or other utilities are encountered during excavation or execution of work. Cooperate with Department and public or private utility companies in keeping their respective service and facilities in operation. Repair damaged utilities to satisfaction of utility Department at no additional cost to Department.
3. Ensure that existing utilities serving facilities occupied by Department or others are not interrupted, except when permitted in writing by Engineer and the Department and then only after temporary utility services have been provided.
4. To ensure that stone columns for vibro-displacement are not installed at locations designated for future structural piles, installation should only be conducted at the locations shown on the roadway plans.

A pre-job conference is required between Engineer, the Department, and Contractor(s), to review special requirements for work. Conference shall be arranged by Contractor and shall be planned sufficiently in advance of work to allow required attendees adequate notice (one week minimum) to make arrangements to attend.

The Contractor shall use a down-hole vibrator capable of providing at least 160 horsepower and 20 tons of force.

Specific equipment and procedural specifications are left to the Contractor to achieve the specified criteria. However, the following general guidelines are identified:

1. After penetration to the treatment depth, the vibrator should be slowly retrieved in 12-inch to 18-inch increments to allow backfill placement.
2. The vibrator should be re-driven through each increment into a recently treated depth interval to observe amperage buildup or increase (or equivalent pressure increase for hydraulic vibrators).
3. Amperage buildup and backfill quantities are contingent to the type of vibrator, type of backfill, in situ soil conditions, and Contractor's procedure. Discussion between the Engineer, the Department, and Contractor shall be conducted prior to work regarding individual equipment capabilities and expectations.

**EXHIBIT 5 - SPECIAL PROVISIONS**

**4.0 QUALITY CONTROL**

Various production columns shall be evaluated by the Engineer and the Department on the basis of volume backfill installed per vibro point. At the request of the Department, Standard and/or Cone Penetration Testing (SPT and/or CPT) will also be performed by the Engineer to explore specific production columns. The test locations shall be determined by the Engineer and the Department once the plans and shop drawings have been received from the Contractor and reviewed, but will typically be as shown on the SC Testing Detail in the project plan sheets. The Contractor shall inform the Engineer 30 days prior to the installation of the first production column so that the field testing can be scheduled appropriately.

The Engineer and/or the Department reserves the right to perform tests and to prepare test reports on items stated below.

The Engineer will make continuous inspections of vibro operations to determine the following:

- a. Proper depth of penetration is obtained
- b. Volume of backfill material installed per vibro point
- c. Theoretical column diameter

The Contractor shall furnish a complete log for each vibro point on the project, to include the following:

- a. Column identification
- b. Date of installation
- c. Recording of probe number
- d. Start/finish time of probe
- e. Approximate backfill quantities
- f. Diameter of column
- g. Location of column
- h. Existing ground surface elevation
- i. Top and bottom elevation of each column

The acceptance criteria for the stone columns shall be the diameter and spacing to create the required minimum area replacement ratio.

**5.0 MEASUREMENT AND PAYMENT**

The quantity of ground modification measured for payments shall be the actual length of the installed stone columns acceptable to the Engineer and the Department. No payment will be made for ground modification beyond the limits required by the Contract Documents, unless such increases in the specified area are ordered by the Engineer in writing.

The accepted quantity, measured as above, will be paid for at the contract unit price per linear foot for Ground Modification, which price and payment shall be full compensation for mobilization, demobilization, furnishing, hauling, treating, compacting of materials, removal of spoils, constructing working platform, pre-augering/obstructions and for all labor, equipment, tools, maintenance, and incidentals necessary to complete this item of work.

Payment will be made under:

<u>Item No.</u>	<u>Pay Item</u>	<u>Pay Unit</u>
2051112	Ground Modification – Vibro-Stone Column	Linear feet



**(77) DIVISION 200: LIGHTWEIGHT AGGREGATES**

**1.0 Description.** This work shall consist of furnishing, loading, hauling, placing and compacting lightweight aggregates (either man-made or natural) for use as fill materials in accordance with these specifications. The lightweight aggregate must be manufactured by expanding shale, clay, or slate in a rotary kiln operation or be naturally made. Wood fiber, blast furnace slag, fly ash, shredded tires, or boiler slag will not be allowed. The material must be sub angular to angular conforming to ASTM C 330 (latest edition). The material requirements presented in this specification are appropriate for borrow materials placed in embankments or placed as retained materials. If lightweight aggregates are used as reinforced backfill materials for the construction of Mechanically Stabilized Earth (MSE) walls or other reinforced soil structures, additional material properties, construction, and testing frequency requirements may be required based on the appropriate specifications.

**2.0 Material.** The Lightweight aggregate must have a proven record of durability, be non-corrosive, and conform to the following requirements:

- pH (AASHTO T-289): pH values shall range between 5 and 10.
- Organic Content (AASHTO T-267): Organic content shall be less than 0.1 percent (weight of organic material to weight of total sample).
- Soundness Loss (AASHTO T104): Soundness loss shall be less than 15% when subjected to 5 cycles of Sodium Sulfate.
- Los Angeles Abrasion (AASHTO T96): Abrasion loss shall be less than 45%.
- Chloride Content (AASHTO T291): Chloride content shall be less than 100 ppm.
- Sulfate (AASHTO T-290): Sulfate content shall be less than 200 ppm.
- Resistivity (ASTM D1125): Resistivity must be greater than 3000-ohm-cm. If resistivity is greater than 5000-ohm-cm, chloride and sulfate requirements and testing are waived.
- Absorption (AASHTO T19): Absorption must be less than 6%.
- Gradation (ASTM 136): The gradation will be as shown in the following Table. Other gradations may be acceptable upon approval by the Engineer and the Department.

**Table – Lightweight Aggregate Gradation**

Sieve Size or Number	Percent Passing
¾ inch	100
½ inch	90 – 100
3/8 inch	50 – 90
No. 4	0 – 50
No. 8	0 – 20
No. 16	Less than 10
No. 30	Less than 10
No. 50	Less than 5
No. 100	Less than 5

- The coefficient of uniformity,  $C_u$ , shall be 4 or greater. The coefficient of uniformity,  $C_u$ , shall be computed as follows:

$$C_u = \frac{D_{60}}{D_{10}}$$

**EXHIBIT 5 - SPECIAL PROVISIONS**

Where  $D_{60}$  is the particle diameter at 60% passing and  $D_{10}$  is the particle diameter at 10% passing. Written approval from the DOC will be required to use soils with a coefficient of uniformity,  $C_u$ , less than 4.

- Aggregate loose unit weight (ASTM C29): The loose unit weight must be less than 45 lbs/ft<sup>3</sup>.
- In-place density: (ASTM D4253, and D4254): The in-place compacted dry unit weight must be between 55 and 60 lbs/ft<sup>3</sup>. Material must be compacted to a minimum 65% relative density as determined by ASTM D4253 and D4254. Use a vibratory table when determining the maximum index density and unit weight in accordance with ASTM D4253. Determine the minimum index density and unit weight in accordance with ASTM D4254.
- Angle of Internal Friction (AASHTO T 236): The minimum angle of internal friction must be 40 degrees. Test a saturated representative sample (with particles larger than larger than 0.75 inch removed) in a round or square shear box that is a minimum of 12 inches across. Test sample shall be compacted to a minimum 65% relative density as determined by ASTM D4253 and D4254.

**3.0 Construction.** Place the lightweight fill in uniform layers. When required by the Engineer and/or the Department, compact each layer using vibratory compaction equipment weighing no more than 10 tons. Place layers no more than 12 inches in depth loose thickness and compact. Compact with three passes of an 8 – 10 ton vibratory roller in the vibratory mode if necessary, or as directed by the Engineer and/or the Department. In confined areas use vibratory plate compaction equipment (5 hp to 20 hp) with a minimum of two passes in 6” lifts for a 5 hp plate and 12” lifts for a 20 hp plate. The contractor must take all necessary precautions when working on or near the lightweight fill to ensure that the material is not over compacted. Construction equipment, other than for placement and compaction, must not operate on the exposed lightweight fill. Low ground pressure equipment (D6 LGP or lighter) is recommended for spreading and placing the lightweight aggregate.

**4.0 Testing Frequency:** All soil property requirements shall be tested during initial source evaluation or if a change in source is requested. Lightweight aggregate material shall be sampled once every 2,000 cubic yards and tested for gradation and pH. Lightweight aggregate material shall be sampled once every 5,000 cubic yards and tested for internal friction angle, organic content, resistivity, chloride content, and sulfate content. Chloride and sulfate content testing will not be required if resistivity test results indicate 5000 ohm-cm or greater. The internal friction angle shall be tested every 2,000 cubic yards if the gradation indicates that the coefficient of uniformity,  $C_u$ , is less than 4. A variation in testing frequency may be required if a variation in material gradation or composition is observed.

**5.0 Measurement and Payment.** Measurement of lightweight aggregate shall be the actual volume in-place at the project site. All costs for furnishing, loading, hauling, placing and compacting lightweight aggregates (either man-made or natural) shall be included in the unit price of the lightweight aggregates.

**Payment will be made under:**

Item No.	Pay Item	Pay Unit
2033020	Borrow Excavation (Lightweight)	CY

**(78) DIVISION 200: HIGH-STRENGTH GEOTEXTILE FOR EMBANKMENT REINFORCEMENT**

June 17, 2010

**1.0 DESCRIPTION**

This work shall consist of furnishing and installing construction geotextiles in accordance with the details shown in the plans, specifications, or as directed by the RCE.

**EXHIBIT 5 - SPECIAL PROVISIONS**

**2.0 MATERIALS**

A geotextile is defined as any permeable polymeric textile used with foundation, soil, rock, earth, or any other geotechnical engineering related material, as an integral part of a civil engineering project, structure, or system. Use geotextiles and thread used in joining geotextiles manufactured from fibers consisting of long-chain polymers, composed of at least 95 percent by weight of polyolefins or polyesters. Use geotextiles with fibers formed into a stable network such that the fibers or yarns retain their dimensional stability relative to each other, including selvages (edges) during shipping, handling, placement, and in service. Use geotextile free from defects or tears.

- E. **Minimum Average Roll Values:** All property values, with the exception of Apparent Opening Size (AOS), represent Minimum Average Roll Values (MARV) in the weakest principal direction. Provide geotextiles whose average test results from any roll sampled in a lot for conformance or quality assurance testing meets or exceeds minimum values provided in this Section.
- F. **Apparent Opening Size:** Values for Apparent Opening Size (AOS) represent maximum average roll values. Acceptance will be based on ASTM D 4759.
- G. **Reinforcement Geotextile:** Use reinforcement geotextile within existing and/or proposed fills for slope reinforcement.

Furnish geotextiles meeting the property requirements outlined in Table 1.

**Table 1: High Strength Geotextile Properties (Design Requirements)<sup>1,2</sup>**

Property	Test Method	Geotextile Property Requirements
Long-Term Design Strength, $T_{al}$ , MD		22,800 lb/ft
Long-Term Design Strength, $T_{al}$ , XD		2,280 lb/ft
Sewn Seam Breaking Strength <sup>3</sup>	ASTM D4884	900 lbs/ft
AOS	ASTM D4751	$\leq (1.0 \text{ to } 2.0)D_{85(\text{soil})}$
Permeability	ASTM D4491	$\geq 10k_{\text{soil}}$
Default Pullout Friction Factor, $F^*$	ASTM D6706	$0.6 \tan \phi$
Default Alpha, $\alpha$	ASTM D6706	0.6
Ultraviolet Stability	ASTM D4355	$\geq 50\%$ after 500 hrs of exposure

Notes: 1. The test procedures shall conform to the most recently approved ATSM geotextile test procedures.

2. All numeric values represent Minimum Average Roll Value (MARV).

3. Applies to factory or field sewn seams.

**2.1 Source Approval and Certification.** Prior to construction, the Contractor shall submit to the Resident Construction Engineer (RCE) a Certification Package prepared by the geotextile reinforcement manufacturer. The Contractor shall allow 21 calendar days from the day the submittals are received by the RCE for review and acceptance. Submit the following information regarding each geotextile proposed for use:

- Manufacturer's name and current address;
- Full product name/number, including roll number;
- Geosynthetic material (i.e. polymer type) and structure (including fiber/yarn type);
- Proposed geotextile use(s); and
- Certified test results for the properties outlined in Table 1 and below in Section 2.

The Certification shall state that the furnished geotextile soil reinforcement is in full compliance with the design requirements as stated in this specification and the design drawings and is fit for use in long-term critical soil reinforcement applications. In addition to the minimum required properties in Table 1, the submittal shall also certify the following values for each geotextile soil reinforcement used on the project:

- 4. The ultimate tensile strength,  $T_{ULT}$ , (MARV) for geogrid soil reinforcements, MD/XD
- 5. The tensile strength at 5% strain, MD
- 6. The creep reduced tensile strength, MD

**EXHIBIT 5 - SPECIAL PROVISIONS**

**7. The geotextile's pullout coefficients ( $F^*$ ,  $\alpha$ )**

The Contractor's submittal package shall include, but not be limited to, actual test results for tension, creep, durability, construction damage, joint/seam strength, pullout and quality control. A person having the legal authority to bond the manufacturer shall attest to the certificate. Any tests required shall be performed at no additional cost to the Department. If in the opinion of the RCE, the required documentation is not provided for individual reduction factors (RF) or pullout coefficients ( $F^*$ ,  $\alpha$ ), default values for these design parameters shall be used in accordance with this specification.

**2.1.1 Ultimate Tensile Strength ( $T_{ult}$ ):** The ultimate tensile strength,  $T_{ult}$ , shall be determined from wide width tensile tests (ASTM D 4595). Geotextile samples tested in accordance with ASTM D 4595 shall be with an 8-inch width specimen, or a 4-inch specimen width with correlation to an 8-inch width. Correlation methodology shall be submitted to, and is subject to acceptance by the RCE. All geotextile strength tests (ASTM D 4595 and ASTM D 6637) shall be conducted at a strain rate of 10% per minute based on actual gage length necessary to meet the testing sample dimension requirements. Laboratory test results documenting the ultimate tensile strength,  $T_{ult}$ , in the reinforcement direction shall be based on the minimum average roll values (MARV) for the product.

**2.1.2 Long-Term (Allowable) Design Tensile Strength ( $T_{al}$ ):** The allowable tensile load per unit width of geotextile soil reinforcement,  $T_{al}$ , in accordance to the backfill type used shall be computed as follows:

$$T_{al} = \frac{T_{ult}}{RF}$$

**2.1.3 Reduction Factor (RF):** The total reduction factor, RF, is the combined reduction factor for long-term degradation due to installation damage, creep, and durability. The total reduction factor, RF, shall be defined as follows:

$$RF = RF_{ID} \times RF_{CR} \times RF_D \geq 3.0$$

The individual reduction factors shall be documented in accordance with the site conditions, design calculations, and specifications. When sufficient documentation is not provided for individual reduction factors,  $RF_{ID}$ ,  $RF_{CR}$ , and  $RF_D$ , a reduction factor RF of 7.0 shall be used. The reinforcement manufacturer shall certify and document the individual reduction factors as follows:

**2.1.4 Installation Damage Reduction Factor ( $RF_{ID}$ ):** The reduction factor for installation damage,  $RF_{ID}$ , shall be documented by field and laboratory test results and literature review, as described in ASTM D 5818 for the reinforced backfill specified or for more severe soils. Samples subjected to installation damage shall be tested for tensile strength and deformation characteristics in accordance with ASTM D 4595. Recommended values for reduction factors for installation damage ( $RF_{ID}$ ) for various soils shall also be documented. The minimum installation damage reduction factor,  $RF_{ID}$ , shall be 1.1, regardless of product specific test results.

**2.1.5 Creep Reduction Factor ( $RF_{CR}$ ):** Laboratory test results documenting creep performance over a range of load levels, for a minimum duration of 10,000 hours based on tension creep test (ASTM D 5262) shall be required. Creep test samples shall be of sufficient width to be representative of overall product creep response (fiber creep testing will not be accepted).

The creep-limiting strength,  $T_l$ , shall be based on extrapolating the 10,000 hours (or longer duration) tension creep tests to a 75-year design life, unless a 100-year design life is specified in the plans. The creep extrapolation method shall be based on methods described in FHWA NHI-10-025, "Design and Construction of Mechanically Stabilized Earth Walls and Reinforced Soil Slopes" - Appendix "D". Laboratory test results and extrapolation methodology shall be documented.

The reduction factor for creep,  $RF_{CR}$ , is defined as the ratio of the average lot specific ultimate tensile strength,  $T_{ULTLOT}$ , to the creep-limiting strength,  $T_l$ . The average lot specific ultimate tensile

## EXHIBIT 5 - SPECIAL PROVISIONS

strength,  $T_{ULTLOT}$ , for the lot of material used for creep testing,  $T_{ULTLOT}$ , shall be determined from wide width tensile test, ASTM D 4595.

**2.1.6 Durability Reduction Factor ( $RF_D$ ):** The total reduction factor for durability,  $RF_D$ , shall be defined as the combined effects of chemical and biological degradation. Laboratory test results, extrapolation techniques, and a comprehensive literature review shall document the reduction factor for durability for all material components in accordance with FHWA NHI-09-087, "*Corrosion/Degradation of Soil Reinforcements for Mechanically Stabilized Earth Walls and Reinforced Soil Slopes*". The minimum durability reduction factor,  $RF_D$ , shall be 1.1, regardless of product specific test results.

**2.1.7 Soil Reinforcement Pullout Coefficients ( $F^*$ ,  $\alpha$ ):** The Certification Package shall document the pullout coefficients ( $F^*$ ,  $\alpha$ ) meet or exceed the required coefficients necessary to obtain the  $T_{ai}$  provided above where,

$F^*$  = Minimum pullout friction factor =  $C_i \tan \Phi$ ,  
 $C_i$  = soil interaction coefficient  $\geq 0.6$   
 $\Phi$  = Soil Angle of Internal Friction

The pullout friction factor,  $F^*$ , and the scale effect correction factor,  $\alpha$ , shall be documented by laboratory testing from pullout tests. Pullout testing shall be conducted for site-specific materials or for materials representative of the reinforced backfill at confining pressures ranging from 2 to 10 psi. When laboratory tests are used from representative soils, the representative soils shall be documented by providing the soil's angle of internal friction, gradation, and coefficient of uniformity ( $C_u = D_{60}/D_{10}$ ). Recommended pullout coefficients for various soil types shall also be documented. The pullout coefficients shall be determined by using the quick effective stress pullout tests ("Measuring Geosynthetic Pullout Resistance in Soil" per ASTM D 6706). The soil interaction coefficient,  $C_i$ , shall be documented when computing the pullout friction factor,  $F^*$ . When sufficient documentation is not provided for pullout coefficients,  $F^*$  and  $\alpha$ , and the coefficient of uniformity,  $C_u$ , is greater or equal to 4, the default values indicated in this specification can be used. If the coefficient of uniformity of the reinforced backfill is less than 4, laboratory pullout test shall be required to determine pullout friction factor,  $F^*$ , and the default scale effect factor,  $\alpha$ .

**2.2 Sample Approval.** To confirm that the on-site geotextile meets the property values specified, random samples shall be submitted to the RCE for evaluation. The machine direction shall be marked clearly on each sample submitted for evaluation. The machine direction is defined as the direction perpendicular to the axis of the roll.

Cut a sample from the geotextile roll with the minimum dimensions of 4 feet by the full width of the roll beyond the first wrap. The geotextile samples shall be cut from the roll with scissors, sharp knife, or other suitable method that produces a smooth edge and does not cause geotextile ripping or tearing. Submit a manufacturer's certificate of compliance signed by an authorized manufacturer's official. The certificate must attest that the geotextile meets all the Minimum Average Roll Value (MARV) requirements specified in Table 1 as evaluated under the manufacturer's quality control program. Geotextiles supplied for construction of the project shall be certified in accordance with the following criteria. The tests described in the specification shall be conducted by the manufacturer or by an approved independent testing laboratory on samples taken from the same lot number as the material actually shipped to the project and at the specified frequency. The manufacturer or independent testing laboratory shall maintain the appropriate accreditations and must be preapproved by the Department. All rolls shall be marked with individual and distinct roll numbers. All roll numbers shall have traceable certified mill test reports from the given lot that they were manufactured. These test reports must be supplied to the Department prior to installation of any geotextile materials. After the sample and the required information have been submitted to the RCE, allow 30 calendar days for evaluation.

Product acceptance is determined by comparing the average test results of all specimens within a given sample to the Minimum Average Roll Values (MARV) listed in Table 1. Install geotextiles only after

## EXHIBIT 5 - SPECIAL PROVISIONS

the material has been tested and/or evaluated and accepted. Replace all geotextiles installed prior to acceptance that do not meet specifications at Contractor's expense.

**2.2.1 Sewn Seam Approval.** If the geotextile seams are to be sewn in the field, the Contractor shall provide a section of sewn seam that can be sampled by the RCE before the geotextile is installed. The sewn seam shall be in accordance with ASTM 6193.

The seam sewn for sampling shall be sewn using the same equipment and procedures as will be used to sew the production seams. The seam sewn for sampling must be at least 6 feet in length. If the seams are sewn in the factory, the Contractor shall provide samples of the factory seam at random from any of the rolls to be used. Regardless of whether the seam is to be sewn in the factory or the field, the manufacturer and/or Contractor shall certify that the strength meets the requirement set forth in Table 1. If seams are to be sewn in both the machine and cross-machine direction, provide samples of seams from both directions. The seam assembly description shall be submitted by the Contractor to the Engineer and the Department and will be included with the seam sample obtained for testing. This description shall include the seam type, stitch type, sewing thread type(s), and stitch density.

If sewn seams are used for seaming the geotextile, use thread that consists of high strength polypropylene or polyester. Do not use nylon thread. Use thread that is of contrasting color to that of the geotextile itself.

If the manufacturer can provide a  $T_{ai}$  MD that is greater than the sum of the required  $T_{ai}$  MD and sewn seam breaking strength (for each specified in the project plans), the sewn seams may be eliminated and a minimum overlap of 1 foot may be used.

**2.3 Identification, Shipment and Storage.** Conform to ASTM D 4873, *Standard Guide for Identification, Storage, and Handling of Geotextiles*. Clearly label each roll of geotextile shipped to the project with the name and address of the manufacturer, full product name/number, quantity, and roll number.

The RCE will reject materials that are mislabeled or misrepresented. Wrap each roll with a material that protects the geotextile, including ends of the roll, from damage due to shipment, water, sunlight, and contaminants. Maintain the protective wrapping during periods of shipment and storage. Do not damage the geotextile or wrapping when unloading or transferring from one location to another. Do not drag the rolls.

During storage, elevate geotextile rolls off the ground and adequately cover to protect them from the following:

- Site construction damage;
- Precipitation;
- Ultraviolet radiation including sunlight;
- Chemicals that are strong acids or strong bases;
- Flames including welding sparks, temperatures in excess of 140 °F (60 °C); and
- Mud, dirt, dust, debris and any other environmental condition that may damage the physical property values of the geotextile.

### 3.0 CONSTRUCTION REQUIREMENTS

**3.1 General.** Prepare the surface on which the geotextile is to be placed so that no damage occurs to the geotextile. Do not drive or operate any construction equipment on the geotextile. Dispose of material with defects, rips, holes, flaws, deterioration, or other damage. Do not use defective material in the work. The manufacturer shall be present on site for a minimum of two days of geotextile installation such that the manufacturer observes any field-sewn seams.

**3.2 Installation Plan.** Within thirty (30) calendar days after award of the contract or no later than thirty (30) calendar days before beginning high-strength geotextile installation, the Contractor shall submit to

## EXHIBIT 5 - SPECIAL PROVISIONS

the Department for review a high-strength geotextile installation plan that includes as a minimum the following information:

- a) The Contractor shall certify and provide proof to the Department of experience in the work described. The Contractor shall have successfully installed at least 500,000 square yards of any geotextile that has sewn seams during the last five years. In addition, the Contractor shall have successfully completed at least five projects within the last five years of similar size and complexity to that of the Project.

The Contractor's experience shall be documented by providing a project summary that includes for each referenced project, the project start and completion dates, total quantity of geotextile installed (specifically indicate if high-strength geotextile installed), and a detailed description of the project, site conditions, and subsurface conditions. The project description shall include details of the geotextile materials, the equipment and technique used to install the geotextiles, the average and maximum area of geotextile installed, the client name and address, the name and telephone number of the representative of the consultant and owner for whom the work was performed and who can attest to the successful completion of the work, and any other information relevant to demonstrating the Contractor's qualifications.

- b) Resume of supervisor documenting experience and qualifications in the installation of both normal and high-strength geotextile. The Contractor shall have a full-time supervisor who has been in responsible charge of supervising geotextile installation operations for at least five projects in the last five years. The supervisor shall be present at the work site at all times during installation operations. The acceptability of the supervisor, as well as any replacement for the supervisor, will be subject to the approval of the Department.
- c) Shop drawings showing the planned locations and elevations of all high-strength geotextiles. The installation sequence shall also be provided including any required staging. The shop drawings shall also show the location of the bridge abutment, and the limits of the final embankment and construction staging.
- d) Detailed description of proposed installation procedures.
- e) Proposed methods and equipment for sewn seams.

**3.3 Site Preparation.** Prepare the installation site by clearing, grubbing, and excavating or filling the area to the design grade. This includes removal of topsoil or vegetation. The RCE will identify soft spots and unsuitable areas during site preparation. This may include but not be limited to proof-rolling specific areas defined by the RCE. Excavate these areas and backfill with approved borrow or bridge lift material and compact as specified. The area to be covered by the geotextile shall be graded to a smooth, uniform condition free from ruts, potholes, and protruding objects such as rocks or sticks.

The Contractor may construct a working platform, up to 2 feet in thickness, in lieu of grading the existing ground surface. A working platform is required where stumps or other protruding objects which cannot be removed without excessively disturbing the subgrade are present. These areas shall be prepared in accordance with the 2007 Standard Specifications for Highway Construction. The stumps shall be covered with at least 6 inches of fill before placement of the first geotextile layer.

**3.4 Geotextile Placement.** The geotextile shall be spread immediately ahead of the covering operation. The geotextile shall be laid with the machine direction perpendicular or parallel to centerline as shown in Plans. All seams shall be sewn. Seams to connect the geotextile strips end to end will not be allowed. The geotextile shall not be left exposed to sunlight during installation for a total of more than 14 calendar days. The geotextile shall be laid smooth without excessive wrinkles. Under no circumstances shall the geotextile be dragged through mud or over sharp objects, which could damage the geotextile.

Small soil piles or the manufacturer's recommended method shall be used as needed to hold the geotextile in place until the specified cover material is placed. Remove wrinkles and folds by pulling the geotextile taut as required.

## EXHIBIT 5 - SPECIAL PROVISIONS

Should the geotextile be torn or punctured or the sewn joints disturbed, as evidenced by visible geotextile damage, subgrade pumping, intrusion, or roadbed distortion, the backfill around the damaged or displaced area shall be removed and the damaged area repaired or replaced by the Contractor at no expense to the Department. The repair shall consist of a patch of the same type of geotextile placed over the damaged area. The patch shall be sewn at all edges.

If geotextile seams are to be sewn in the field or at the factory, the seams shall consist of two parallel rows of stitching, or shall consist of a J-seam, Type SSn-2. The two rows of stitching shall be 1 inch apart with a tolerance of plus or minus 0.5 inches and shall not cross, except for restitching. The stitching shall be a lock-type stitch. The minimum seam allowance, i.e., the minimum distance from the geotextile edge to the stitch line nearest to that edge, shall be 1.5 inches if a flat or prayer seam, Type SSa-2, is used. The minimum seam allowance for all other seam types shall be 1 inches. The seam, stitch type, and the equipment used to perform the stitching shall be as recommended by the manufacturer of the geotextile and as approved by the RCE.

The seams shall be sewn in such a manner that the seam can be inspected readily by the RCE or his representative. The seam strength will be tested and shall meet the requirements stated herein.

**3.5 Fill Placement.** Embankment construction shall be kept symmetrical at all times to prevent localized bearing capacity failures beneath the embankment or lateral tipping or sliding of the embankment. Place fill over the geotextile by dumping onto previously placed material and pushing the material into place. Stockpiling of fill on the geotextile will not be allowed.

The cover material shall be placed on the geotextile in such a manner that a minimum of 8 inches of uncompacted material will be between the equipment tires or tracks and the geotextile at all times. Construction vehicles shall be limited in size and weight such that rutting in the initial lift above the geotextile is not greater than 3 inches deep, to prevent overstressing the geotextile. Do not blade material down to remove ruts. Fill any ruts or depressions with additional material and compact to the specified density. Turning of vehicles on the first lift above the geotextile will not be permitted. If the geotextile is being placed on soft ground, compaction of the first lift above the geotextile shall be limited to routing of placement and spreading equipment only. If groundwater is present within 2 feet of the any lift, vibratory compaction shall not be used. If the subgrade is very soft with an undrained shear strength less than 500 psf minimize pile heights to less than 3 feet and spread piles as soon as possible after dumping to minimize the potential for localized subgrade failure due to overloading of the subgrade.

A sandy material that meets the requirements of an A-2 AASHTO soil classification shall be the only borrow excavation soil allowed for placement between the lowest elevation geotextile and the bottom of the pavement section. The embankment fill soils shall be compacted in accordance with the 2007 Standard Specifications for Highway Construction. Fill shall be placed in 12-inch maximum lift thicknesses where heavy compaction equipment is to be used and 6-inch maximum uncompacted lift thicknesses where hand-operated equipment is used.

The geotextile shall be pretensioned during installation using either Method 1 or Method 2 as described herein. The method selected will depend on whether or not a mudwave forms during placement of the first one or two lifts. If a mudwave forms as fill is pushed onto the first layer of geotextile, Method 1 shall be used. Method 1 shall continue to be used until the mudwave ceases to form as fill is placed and spread. Once mudwave formation ceased, Method 2 shall be used until the uppermost geotextile layer is covered with a minimum of 1 foot of compacted fill. These special construction methods are not needed for fill construction above this level. If a mudwave does not form as fill is pushed onto the first layer of geotextile, then Method 2 shall be used initially and until the uppermost geotextile layer is covered with at least 1 foot of compacted fill.

### Method 1

After the working platform, if needed, has been constructed, the first layer of geotextile shall be laid as outlined in the project plans and the joints sewn together. The geotextile shall be



**EXHIBIT 5 - SPECIAL PROVISIONS**

stretched manually to ensure that no wrinkles are present in the geotextile. The fill shall be end-dumped and spread from the edge of the geotextile. The fill shall first be placed along the outside edges of the geotextile to form access roads. These access roads will serve three purposes: to lock the edges of the geotextile to form access roads, to contain the mudwave, and to provide access as needed to place fill in the center of the embankment. These access roads shall be approximately 16 feet wide. The access roads at the edges of the geotextile shall have a minimum height of 2 feet completed. Once the access roads are approximately 50 feet in length, fill shall be kept ahead of the filling operation, and the access roads shall be kept approximately 50 feet ahead of this filling operation. Keeping the mudwave ahead of this filling operation and keeping the edges of the geotextile from moving by use of the access roads will effectively pre-tension the geotextile. The geotextile shall be laid out no more than 20 feet ahead of the end of the access roads at any time to prevent overstressing of the geotextile seams.

Method 2

After the working platform, if needed, has been constructed, the first layer of geotextile shall be laid and sewn as in Method 1. The first lift of material shall be spread from the edge of the geotextile, keeping the center of the advancing fill lift ahead of the outside edges of the lift. The geotextile shall be manually pulled taut prior to fill placement. Embankment construction shall continue in this manner for subsequent lifts until the uppermost geotextile layer is completely covered with 1 foot of compacted fill.

**4.0 METHOD OF MEASUREMENT**

Measurement of geotextile is on a square yard basis and will be computed based on the total area of geotextile shown in the plans, exclusive of the area of geotextiles used in any overlaps, seams, and/or joints. This shall include all costs associated with installation of the geotextile. Overlaps and any geotextile waste are an incidental item.

**5.0 BASIS OF PAYMENT**

Payment at the contract unit price is full compensation for all resources necessary to complete the item of work under the contract. Payment for the completed and accepted quantities is made under the following:

<b>Item No.</b>	<b>Pay Item</b>	<b>Unit</b>
2037110	GEOTEX REINF.	SY

**(79) SECTION 203: MUCK EXCAVATION**

September 19, 2011

Section 203.2.1.3 is amended as follows:

Any areas identified on the plans and any additional areas defined by the RCE that are discovered to deflect or settle may require corrective action by the Contractor. This may include undercutting, placing granular aggregate, placing stone aggregate that is separated from other fine aggregate materials by a geotextile for separation of sub-grade and sub-base, and/or additional compacting to the approval of the Engineer **and the Department**.

In areas that require mucking or undercutting, borrow excavation soil may be placed as a bridge lift as long as the grade on which the material is being placed is at least 2 feet above ground water level. In the

## EXHIBIT 5 - SPECIAL PROVISIONS

event that groundwater does not allow backfilling with a borrow excavation soil, a stone or granular material shall be used as the bridge lift material. This stone or granular material shall be in accordance with the Bridge Lift Materials Special Provision. Stone bridge lift materials shall have a thickness of 2 feet and shall extend a minimum of 6 inches above the ground/surface water level. Granular lift materials shall also have a thickness of 2 feet, but shall extend a minimum of 2 feet above ground/surface water level. Individual granular bridge lifts shall not exceed a 2-foot thickness without some type of limited compactive/tamping effort. The depth at which mucking or undercutting shall take place is dependent upon encountering a suitable bearing material within the excavation or a predetermined elevation or depth. In most cases, undercutting shall not exceed 3 to 5 feet in depth, but the final mucking or undercutting thickness shall be based on the decision of the RCE, unless otherwise specified in the project plans and/or specifications. If a suitable bearing soil is not encountered within this depth range or unless otherwise specified in the plans and/or specifications, a P1 biaxial geogrid with an aperture size of less than or equal to 1 inch shall be placed beneath the stone or granular bridge lift material. The geogrid shall be placed in the bottom of the excavation and up the excavation side slopes. If additional compacted borrow excavation soil is needed to reach grade, a geotextile for separation of sub-grade and sub-base shall be placed between any stone bridge lift material and the overlying compacted soil. A bridge lift consisting of borrow excavation soil or granular bridge lift material should not be placed within 3 feet of the base of the pavement section. Only compacted borrow excavation soil or stone bridge lift material shall be placed within this zone. The biaxial geogrid shall be in accordance with the Special Provision provided in the project documents.

The quantities associated with mucking and undercutting, i.e. mucking, stone and granular bridge lift materials, geogrid, and geotextile for separation of sub-grade and sub-base, are for bid estimation purposes only. These bid items shall not be purchased and stockpiled on site without written approval from the RCE unless specific areas and details are defined in the plans.

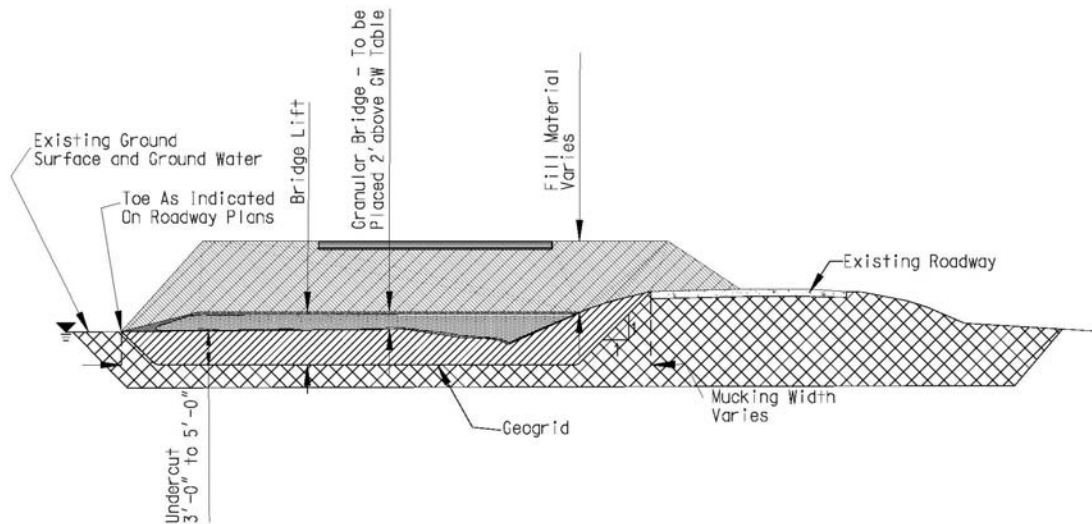

### UNDERCUT, GEOGRID, AND GRANULAR BRIDGE LIFT

## EXHIBIT 5 - SPECIAL PROVISIONS

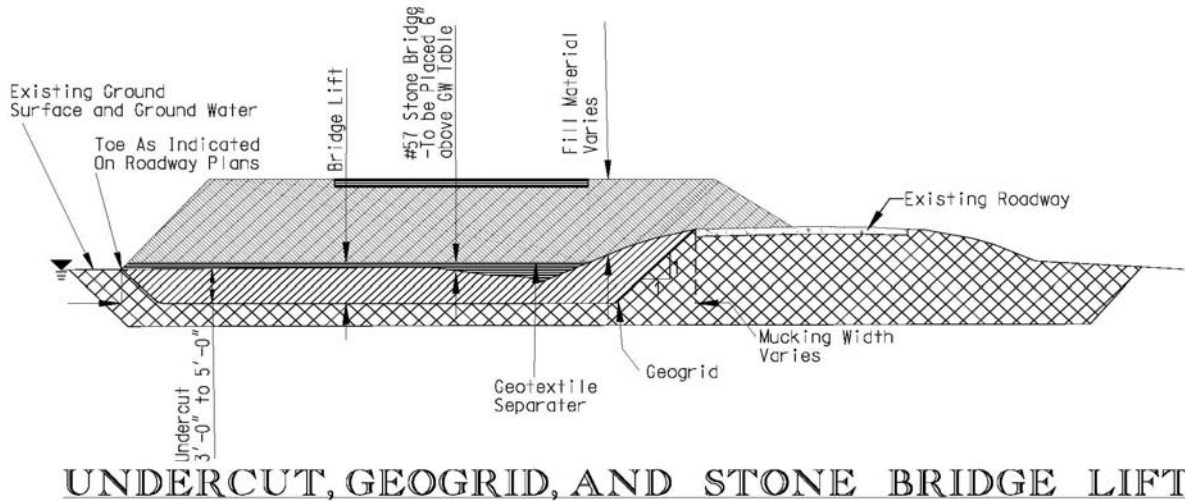

### (80) DIVISION 200: PREFABRICATED EARTHQUAKE DRAIN WITH FILTER FABRIC

January 24, 2012

Division 200 is expanded as follows:

#### 1.0 DESCRIPTION OF WORK

This work shall consist of furnishing all necessary submittals, materials, labor, equipment, and incidentals for the installation of prefabricated earthquake drains in accordance with the details shown on the plans and the requirements of the Supplemental Specifications. The earthquake drains shall consist of a corrugated pipe with slot type perforations enclosed by a geotextile filter fabric. Space within the pipes above the ground water table provides a reservoir for water expelled from the ground for liquefaction prevention. If required, additional reservoir space shall be constructed in accordance with details shown on the project drawings. The earthquake drains shall be installed at locations shown on the plans, unless otherwise directed by the Engineer **and the Department**. The earthquake drains shall be installed to full length without splicing. If splicing is required the Contractor shall contact the Department for instruction and additional requirements.

#### 2.0 QUALITY ASSURANCE

##### 2.1 Standards: American Society for Testing and Material (ASTM)

ASTM D3776 Standard Test Method for Measuring Mass per Unit Area of Geotextiles

ASTM D3786 Standard Test Method for Hydraulic Bursting Strength of Textile Fabrics – Diaphragm Bursting Strength Tester Method

ASTM D4491 Standard Test Method for Water Permeability of Geotextiles by Permittivity

ASTM D4533 Standard Test Method for Trapezoid Tearing Strength of Geotextiles

ASTM D4632 Standard Test Method for Grab Breaking Load and Elongation of Geotextiles

ASTM D4833 Standard Test Method for Index Puncture Resistance of Geotextiles, Geomembranes, and Related Products

## EXHIBIT 5 - SPECIAL PROVISIONS

**2.2 Quality Control:** The earthquake drains shall be installed with equipment that will maintain the mandrel in a vertical position. The Contractor shall consider the subsoils at the site when selecting equipment and developing the earthquake drain installation plan. The equipment shall generate sufficient pressure necessary to install the earthquake drains through all existing subsurface material to the depths shown on the plans. The equipment shall have the capability of installing the earthquake drains to a depth of not less than 10 feet greater than the maximum earthquake drain depth shown on the plans.

Approval of the sample earthquake drain material by the Engineer and the Department will be required prior to delivery of the earthquake drain material to the Project. The earthquake drain manufacturer shall be a specialist in the manufacture of earthquake drains, and shall have produced a minimum of 1,000,000 linear feet of the earthquake drain material proposed for the Project, that have been used in successful applications within the past five years.

The earthquake drains shall be free of defects, rips, holes, and/or flaws. During shipment and storage, the earthquake drains shall be wrapped in a protective covering. The earthquake drains shall be protected from sunlight, mud, dirt, dust, debris, and detrimental substances during shipping and on-site storage.

The Contractor shall certify and provide proof to the Department of experience in the work described. The Contractor shall have successfully installed at least 2,000,000 linear feet of earthquake drains during the last five years. In addition, the Contractor shall have successfully completed at least five projects within the last five years of similar size and complexity to that of the Project.

The Contractor's experience shall be documented by providing a project summary that includes for each referenced project, the project start and completion dates, total quantity of earthquake drains installed, and a detailed description of the project, site conditions, and subsurface conditions. The project description shall include details of the earthquake drain materials, the equipment and technique used to install the earthquake drains, the average and maximum length of earthquake drain installed, the client name and address, the name and telephone number of the representative of the consultant and owner for whom the work was performed and who can attest to the successful completion of the work, and any other information relevant to demonstrating the Contractor's qualifications.

The Contractor shall have a full-time supervisor who has been in responsible charge of supervising earthquake drain installation operations for at least five projects in the last five years. The supervisor shall be present at the work site at all times during earthquake drain installation operations. The acceptability of the supervisor, as well as any replacement for the supervisor, will be subject to the approval of the Department.

### 3.0 SUBMITTALS

**3.1 Prefabricated Earthquake Drain Installation Plan:** Within thirty (30) calendar days after award of the contract or no later than thirty (30) calendar days before beginning earthquake drain installation, the Contractor shall submit to the Department for review an earthquake drain installation plan that includes as a minimum the following information:

- a) Size, type, weight, maximum pushing force, vibratory-hammer rated energy, and configuration of the installation rig.
- b) Dimensions and length of the mandrel.
- c) Details of earthquake drain anchorage.
- d) Detailed description of proposed installation procedures.
- e) Proposed methods and equipment for pre-augering.
- f) Documentation of the successful application of the proposed earthquake drain installation operations.
- g) Method of measuring the installed length of the earthquake drain.

## EXHIBIT 5 - SPECIAL PROVISIONS

- h) Shop drawings showing the planned locations and bottom elevations of all earthquake drains and showing a unique identification number for each earthquake drain. The installation sequence shall also be provided. The shop drawings shall also show the location of the bridge abutment, and the limits of the final embankment and construction staging.
- i) Resume of supervisor documenting experience and qualifications in the installation of earthquake drains.

**3.2 Prefabricated Earthquake Drain Material:** At least thirty (30) calendar days before beginning earthquake drain installation, the Contractor shall:

- a) Submit to the Department for testing three samples of the earthquake drain to be used, with the accompanying manufacturer specifications for the earthquake drain material. The samples of the earthquake drain shall be at least five feet long. The samples shall be stamped or labeled by the manufacturer as being representative of the earthquake drain material having its specified trade name.
- b) Submit to the Department three samples of the proposed anchor plate to be used to anchor the earthquake drains at the design depth shown on the plans.
- c) Submit to the Department manufacturer's literature documenting the physical and mechanical properties of the earthquake drain components. Submit to the Department a manufacturer's list of other similar projects where the same drain has been installed, including details on prior performance on these projects.
- d) The Contractor shall identify the proposed source of the materials prior to delivery to the site. The Contractor shall supply a manufacturer's material certification that the earthquake drain with filter fabric meets or exceeds the material requirements of this Special Provision.

**3.3 Submittal Reviews:** All submittals to the Department shall be reviewed according to Section 725 of the SCDOT Standard Specifications for Highway Construction. The submittals shall be reviewed and accepted or rejected within twenty-one (21) calendar days of receipt by the Department. Acceptance of the proposed materials, equipment, construction sequence, and method by the Department shall not relieve the Contractor of its responsibility to install the earthquake drains in accordance with the plans and Special Provision. Approval by the Department of the method and equipment to be used to install the earthquake drains shall be contingent upon satisfactory demonstration of earthquake drain installation at the project site. If, at any time, the Department or the Engineer considers that the method of installation does not produce satisfactory earthquake drains, the Contractor shall alter the method and/or equipment as necessary to comply with the Special Provision. The Department will be the sole judge in determining the adequacy of the Contractor's methods and equipment.

**3.4 As-Built Plans:** The Contractor shall provide the Department with "as-built" plans of the earthquake drain installation. Such plans shall include the locations of the earthquake drains, the date the drains were installed, the surface elevation at the drain installation, the "as-built" vertical drain tip elevation, and shall identify any rejected or abandoned drain installations. "As-built" plans shall be submitted at least weekly during earthquake drain installation operations. A final "as-built" plan shall be submitted within seven calendar days of the completion of earthquake drain installation in all embankment locations. The final "as-built" plans will be subject to the approval of the Department.

### 4.0 MATERIALS

**4.1** The earthquake drains shall consist of newly manufactured materials and shall consist of an annular-corrugated interior and exterior plastic drainage core wrapped in a non-woven geotextile filter fabric. The filter fabric shall allow free passage of pore water to the core without loss of soil material or piping. The core shall provide drainage through slot type perforations and a reservoir in the space above the ground water table. Optional, additional reservoir space may take the form of a naturally occurring permeable soil layer if such layer is present. In other cases an artificial reservoir may need to be provided. This

**EXHIBIT 5 - SPECIAL PROVISIONS**

artificial reservoir may take any of several forms, ranging from a layer of open graded stone applied over the area, to individually constructed reservoirs at each drain as specified in the plans. The prefabricated earthquake drain material shall meet the following specifications:

Nominal Inside Diameter	As indicated on the plans
Minimum Pipe Stiffness @ 5% Deflection:	35psi
Minimum Drainage Slot Area:	0.013 ft <sup>2</sup> /ft
Minimum Water Permeability, fabric: (ASTM D4491)	0.01 in/sec (K-value)
Minimum Water Permittivity, fabric: (ASTM D4491)	0.1 sec <sup>-1</sup>
Minimum Tear Strength, fabric: (ASTM D4533)	50 lb
Minimum Tensile Strength, fabric: (ASTM 4632)	90 lb
Minimum Elongation at break: (ASTM D4632)	60 percent
Minimum Puncture Strength, fabric: (ASTM 4833)	35 lb
Minimum Mullen Burst, fabric: (ASTM D3786)	150 psi

**4.2** The filter fabric and core components shall conform to the following:

- a) The filter fabric shall be synthetic non-woven geotextile capable of resisting bending, punching and tensile forces imposed during installation and during the design life of the earthquake drain.
- b) The filter fabric shall not be subject to localized damage (e.g., punching through the filter by sand/gravel particles).
- c) The filter fabric shall be rigid enough to withstand lateral earth pressures due to embedment and surcharge so that the vertical flow capacity through the core will not be adversely affected.
- d) The filter fabric shall be flexible enough to bend smoothly during installation and induced densification without damage.
- e) The filter fabric shall not undergo cracking and peeling during installation of the earthquake drain.
- f) The core shall have an annular-corrugated interior and exterior. The assembled earthquake drain shall be resistant against wet rot, mildew, bacterial action, insects, salts in solution in the ground water, acids, alkalis, solvents, and other ingredients in the site ground water.

**4.3** Earthquake drain materials shall be labeled or tagged in such a manner that the information for sample identification and other quality control purposes can be read from the label. As a minimum, each roll shall be identified by the manufacturer as to lot or control numbers, individual roll number, date of manufacture, manufacturer and product identification of the filter fabric and core.

During shipment and storage, the earthquake drain shall be wrapped in burlap or similar heavy duty protective covering. The earthquake drain shall be protected from sunlight, mud, dirt, dust, debris, and other detrimental substances during shipping and on-site storage.

## EXHIBIT 5 - SPECIAL PROVISIONS

Material which is damaged during shipment, unloading, storage, or handling, or which does not meet the requirements of the earthquake drain material will be rejected by the Department. No payment will be made for rejected material.

### 5.0 INSTALLATION

**5.1** Earthquake drains shall be installed as indicated on the plans or as directed by the Department. Earthquake drains shall be spaced as indicated on the plans. Earthquake drains shall be installed in stages coinciding with construction stages. Earthquake drains shall be installed using a mandrel or a sleeve that shall advance through the soils to the elevations shown on the plans. The earthquake drains shall be installed using equipment that will maintain the mandrel in a vertical position. The mandrel or sleeve shall protect the drain material from tears, cuts, and abrasion during installation and shall be retracted after each earthquake drain is installed. The mandrel shall be fitted with three symmetrically spaced fins for transmitting vibrations to the soil during installation.

**5.2** The installation rig shall utilize a vibrator with an eccentric moment sufficient to generate vertical vibration to the mandrel during installation. The equipment shall also generate sufficient vertical force (static crowd) to the mandrel to install the earthquake drains through all existing subsurface materials to the depths shown on the plans.

**5.3** The earthquake drain shall be provided with an “anchor” plate or similar arrangement to anchor the bottom of the drain at the required depth during mandrel removal and to prevent soil from entering the bottom of the mandrel during drain installation. The anchorage shall be adequate to keep the bottom of the earthquake drain at the required depth subject to approval and field verification by the Department. The corresponding dimension of the anchor shall conform as closely as possible to the breadth dimensions of the mandrel to minimize soil disturbance.

**5.4** The Contractor shall notify the Department at least 24 hours prior to installation of the initial earthquake drains, to allow the Department sufficient time to provide the necessary inspection for the initial earthquake drain installation. Installation of the initial earthquake drains shall not proceed without the presence of the Department’s inspector. During the installation of the initial ten earthquake drains, the Contractor shall demonstrate that the equipment, method, and material produce a satisfactory installation, as determined by the Department. Following completion of the initial earthquake drain installations, the Contractor shall not proceed with the installation of the remaining earthquake drains until authorized by the Department.

**5.5** If foundations have been previously installed, the prefabricated earthquake drains shall be installed in a manner as to avoid foundation piles or spread footings. The location of the earthquake drains relative to the foundations shall be determined and staked out prior to the installation of the prefabricated earthquake drains. In addition, the Contractor shall be responsible for taking precautions to preserve the stake locations and is responsible for re-staking, if necessary.

**5.6** Earthquake drains shall be located, numbered, and staked out using a baseline and benchmark provided by the Contractor. The Contractor shall be responsible for all other construction staking, for taking precautions to preserve the stake locations, and is responsible for re-staking, if necessary. The as-installed locations of the earthquake drains shall not vary by more than six inches from the locations designated on the plans or approved shop drawings.

**5.7** Earthquake drains that deviate from the plan locations by more than six inches, that are damaged, or improperly installed will be rejected. Rejected earthquake drains shall be abandoned in place. Replacement earthquake drains shall be placed as close as possible to the correct original locations.

**5.8** The Contractor shall provide the Department with a means of verifying the plumbness of the mandrel and determining the depth of the earthquake drains. The equipment shall be checked for plumbness prior to installing each drain and shall not deviate from the vertical more than two percent (2%) during installation.

## EXHIBIT 5 - SPECIAL PROVISIONS

**5.9** Earthquake drains shall be installed as shown on the plans and as directed by the Department. The replacement of existing geotechnical instrumentation, if present, damaged because of the Contractor's activities will be the responsibility of the Contractor, as described in the Special Provision for the geotechnical instrumentation, if required on the project.

**5.10** Earthquake drains shall be installed from the working surface (top of fill soil) to the earthquake drain bottom elevations shown on the plans or to refusal. Refusal shall be defined as the point where the soils resist a reasonable effort at further penetration of the earthquake drains. The refusal criteria shall be established by the Engineer on the basis of existing soil borings and the initial earthquake drain installations to be performed by the Contractor in the presence of the Department's inspector, as specified herein. No earthquake drains shall be terminated above the design earthquake drain bottom elevations shown on the plans without the approval of the Engineer and the Department. The Engineer may vary the depths, spacing, and/or number of earthquake drains to be installed, and may revise the plan limits for this work based on the actual subsurface conditions encountered.

**5.11** The prefabricated earthquake drains shall be cut off neatly at least six inches above the working layer, unless otherwise shown on the plans. The filter fabric shall be knotted at the top of the drain to prevent soil from entering the drain.

**5.12** During earthquake drain installation, the Contractor shall provide the Department with a means of determining the depth of the advancing earthquake drain at any given time and the length of the drain installed at each location. A summary tabulation of the number and length (to the nearest ½-foot) of acceptable earthquake drains shall be submitted daily to the Department.

**5.13** Where obstructions are encountered below the working surface, the Contractor shall install a new drain within an 18 inch radius of the original location of the obstructed drain. A maximum of two additional attempts shall be made as directed by the Department for each obstructed earthquake drain. If the drain still cannot be installed to the design tip elevation, the drain location shall be abandoned and a new drain installed at a location directed by the Department. Locations where earthquake drains do not meet the depth criteria due to obstructions shall be clearly marked in the field. The Engineer will have the right to waive the replacement earthquake drain requirement upon written notice to the Department and the Contractor.

**5.14** Pre-augering for the earthquake drain installation shall be allowed to advance the drains through compacted fill material or other obstructions. The Contractor shall be responsible for penetrating the overlying fill material or any dense layers or obstructions when encountered to satisfactorily install the earthquake drains. Satisfactory installation shall allow for clearing obstructions defined as any man-made or natural object or a stratum that prevents the proper insertion of the mandrel and installation of the earthquake drain. Pre-augering shall not be allowed for the first stage of construction where earthquake drains will penetrate through geotextile, if present.

The Contractor may use augering or other approved methods to loosen the soil and obstructing material prior to the installation of the drains. The obstruction clearance procedure is subject to the approval of the Engineer and the Department; however, such approval shall not relieve the Contractor of the responsibility to clear obstructions in accordance with the specifications.

If augering is the selected method, the augers shall have a minimum outside diameter equal to the largest horizontal dimension of the mandrel, shoe, or anchor, whichever is greatest. The maximum outside diameter of the auger shall be no more than three inches greater than the maximum dimension of the mandrel.

Obstruction clearance procedures shall be kept to a minimum and shall be used only when approved by the Engineer and the Department. Augering or other obstruction removal techniques shall not penetrate more than two feet into the underlying compressible soil.



## EXHIBIT 5 - SPECIAL PROVISIONS

Where obstructions are encountered, the following procedure shall be implemented in the listed sequence:

- a) The Contractor shall immediately notify the Department prior to completing the drain and prior to installing other drains.
- b) The Contractor shall then attempt to install drains adjacent to the obstructed location. Based upon the results of these installations and at the direction of the Department, the Contractor shall:
  1. Attempt to install an offset drain within 18 inches horizontally of the obstructed drain, or
  2. Implement obstruction clearance procedures and install the drain at the design location. Obstruction clearance procedures shall be used only as approved by the Engineer and the Department.

**5.15** Earthquake drains shall be installed using a continuous push using static weight and vibration. Jetting or the use of an impact hammer will not be allowed to install the earthquake drains.

**5.16** A mandrel shall be used to protect the earthquake drains during installation. The mandrel shall be withdrawn after installation of the earthquake drains. In no case will alternative raising and lowering of the mandrel during advancement be permitted. Raising the mandrel will be permitted only after completion of the earthquake drain installation to the bottom of the drain elevation shown on the plans or otherwise authorized by the Engineer and the Department.

### 6.0 MEASUREMENT

**6.1 Prefabricated Earthquake Drains:** This item shall include the furnishing of all materials, supervision, equipment, crews, tools, required permits, survey stake out of earthquake drain locations, and other equipment and materials as necessary to properly execute the work.

The total length of earthquake drains for liquefaction mitigation shall be measured to the nearest one-half foot. The total length of earthquake drains to be paid for shall be as indicated on the plans.

### 7.0 BASIS OF PAYMENT

**7.1 Prefabricated Earthquake Drains:** Payment for earthquake drains shall be made at the contract unit price per linear foot of earthquake drains installed, which price shall be full compensation for the cost of furnishing the full length of the earthquake drain material, installing the earthquake drain, obstruction clearance, altering of the equipment and methods of installation in order to produce the required end result in accordance with the contract documents, and shall also include the cost of furnishing all tools, mobilization, materials, labor, equipment, supervision, survey stake out of earthquake drain locations, and all other costs necessary to complete the required work.

The Engineer may vary the depths, spacing, or numbers of earthquake drains to be installed and may revise the earthquake drain installation limits shown on the plans based on the actual subsurface conditions encountered. Such changes or revisions may increase or decrease the total quantity of the earthquake drains estimated based on the plans. In the event of such changes in required earthquake drain quantity, the payment for earthquake drains shall be made on the basis of the contract unit price per linear foot.

No payment will be made for earthquake drains, or for any delays or expenses incurred through changes necessitated by improper material or equipment.

Payments shall be made under:

**EXHIBIT 5 - SPECIAL PROVISIONS**

Item No.	Pay Item	Pay Unit
2052210	Prefabricated Earthquake Drain with Filter Fabric	LF

**(81) DIVISION 200: PREFABRICATED VERTICAL DRAIN WITH FABRIC**

August 24, 2011

**1.0 DESCRIPTION OF WORK**

This work shall consist of furnishing all necessary submittals, materials, labor, equipment, and incidentals for the installation of prefabricated vertical drains in accordance with the details shown on the plans and the requirements of the Supplemental Specifications. The vertical drains shall consist of a band-shaped plastic core enclosed in a suitable jacket material. The vertical drains shall be installed at locations show on the plans, unless otherwise directed by the Department.

**2.0 QUALITY ASSURANCE**

**2.1 Quality Control:** The vertical drains shall be installed with equipment that will minimize the disturbance of the subsoil during the installation operation and maintain the mandrel in a vertical position. The Contractor shall consider the subsoils at the site when selecting equipment and developing the prefabricated vertical drain installation plan. The equipment shall have sufficient push force necessary to install the vertical drains through all existing subsurface material to the depths shown on the plans. The equipment shall have sufficient power to penetrate into the materials underlying the compressible stratum. The equipment shall have the capability of installing the vertical drains to a depth of not less than 20 feet greater than the maximum vertical drain depth shown on the plans. The equipment shall be selected such that it will not force the fill soil into the existing soil, nor disturb the fill soil, nor cause any bearing capacity problems with the subgrade soils due to the weight of the equipment.

Approval of the sample vertical drain material by the Engineer and the Department will be required prior to delivery of the vertical drain material to the Project. The vertical drain manufacturer shall be a specialist in the manufacture of vertical drains and shall have produced a minimum of 1,000,000 linear feet of the vertical drain material proposed for the Project that have been used in successful applications within the past five years.

The vertical drains shall be free of defects, rips, holes, and/or flaws. During shipment and storage, the vertical drains shall be wrapped in a protective covering. The vertical drains shall be protected from sunlight, mud, dirt, dust, debris, and detrimental substances during shipping and on-site storage.

The Contractor shall certify and provide proof to the Department of experience in the work described. The Contractor shall have successfully installed at least 1,000,000 linear feet of vertical drains during the last five years and shall be a certified installer of the vertical drain manufacturer. In addition, the Contractor shall have successfully completed at least five projects within the last five years of similar size and complexity to that of the Project.

The Contractor's experience shall be documented by providing a project summary that includes for each referenced project, the project start and completion dates, total quantity of vertical drains installed, and a detailed description of the project, site conditions, and subsurface conditions. The project description shall include details of the vertical drain materials, the equipment and technique used to install the vertical drains, the average and maximum length of vertical drain installed, the client name and address, the name and telephone number of the representative of the consultant and owner for whom the work was performed and who can attest to the successful completion of the work, and any other information relevant to demonstrating the Contractor's qualifications.

## EXHIBIT 5 - SPECIAL PROVISIONS

The Contractor shall have a full-time supervisor who has been in responsible charge of supervising vertical drain installation operations for at least five projects in the last five years. The supervisor shall be present at the work site at all times during vertical drain installation operations. The Contractor shall provide a detailed resume of the supervisor's experience and qualifications. The acceptability of the supervisor, as well as any replacement for the supervisor, will be subject to the approval of the Department.

### 3.0 SUBMITTALS

**3.1 Prefabricated Vertical Drain Installation Plan:** Within thirty (30) calendar days after award of the contract or no later than thirty (30) calendar days before beginning prefabricated vertical drain installation, the Contractor shall submit to the Department for review a prefabricated vertical drain installation plan that includes as a minimum the following information:

- a) Size, type, weight, maximum pushing force, vibratory hammer rated energy, and configuration of the installation rig.
- b) Dimensions and length of the mandrel.
- c) Details of vertical drain anchorage.
- d) Detailed description of proposed installation procedures.
- e) Proposed methods for splicing the vertical drains.
- f) Proposed methods and equipment for pre-augering or spudding.
- g) Submit documentation of the successful application of the proposed vertical drain installation operations.
- h) Submit shop drawings showing the planned locations and bottom elevations of all vertical drains and showing a unique identification number for each vertical drain. The installation sequence shall also be provided. The shop drawings shall also show the location of all settlement sensors or plates, the location of the abutment, and the limits of the final embankment.

**3.2 Prefabricated Vertical Drain Material:** At least thirty (30) calendar days before beginning vertical drain installation, the Contractor shall:

- a) Submit to the Department for testing three samples of the unspliced vertical drain to be used and three samples of proposed splices, with the accompanying manufacturer specifications for the vertical drain material. The samples of unspliced vertical drain shall be at least five feet long. Samples of spliced vertical drain shall be long enough to include the splice plus two feet of unspliced drain on both sides of the splice. The samples shall be stamped or labeled by the manufacturer as being representative of the vertical drain material having its specified trade name.
- b) Submit to the Department three samples of the proposed anchor plate to be used to anchor the vertical drains at the design depth shown on the plans.
- c) Submit to the Department manufacturer's literature documenting the physical and mechanical properties of the vertical drain and other similar projects where the same drain has been installed, including details on prior performance on these projects.

## EXHIBIT 5 - SPECIAL PROVISIONS

- d) The Contractor shall identify the proposed source of the materials prior to delivery to the site. The Contractor shall supply a manufacturer's material certification that the prefabricated vertical drain with fabric meets or exceeds the material requirements of this specification.

3.3 **Submittal Reviews:** Approval of the proposed materials, equipment, construction sequence, and method by the Department shall not relieve the Contractor of its responsibility to install the vertical drains in accordance with the plans and specifications. Approval by the Department of the method and equipment to be used to install the vertical drains shall be contingent upon satisfactory demonstration of vertical drain installation at the project site. If, at any time, the Department or the Engineer considers that the method of installation does not produce satisfactory vertical drains, the Contractor shall alter the method and/or equipment as necessary to comply with the Supplemental Specifications. The Department will be the sole judge in determining the adequacy of the Contractor's methods and equipment.

3.4 **As-Built Plans:** The Contractor shall provide the Department with "as-built" plans of the vertical drain installation. Such plans shall include the locations of the vertical drains, the date the drains were installed, the length of each drain below the fill soil surface elevation, the fill soil surface elevation at the drain installation, the "as-built" vertical drain tip elevation, and shall identify any rejected or abandoned drain installations. "As-built" plans shall be submitted at least weekly during vertical drain installation operations. A final "as-built" plan shall be submitted within seven calendar days of the completion of vertical drain installation in all embankment locations. The final "as-built" plans will be subject to the approval of the Department.

### 4.0 MATERIALS

4.1 The prefabricated vertical drain shall consist of newly manufactured materials and shall consist of a continuous plastic drainage core wrapped in a nonwoven geotextile material jacket. The jacket shall allow free passage of pore water to the core without loss of soil material or piping. The core shall provide continuous vertical drainage. The prefabricated vertical drain material shall have a minimum perimeter of 7-1/2 inches and a minimum thickness of 1/8 inch.

4.2 The jacket and core components shall conform to the following:

- a) The jacket shall be synthetic nonwoven geotextile capable of resisting bending, punching and tensile forces imposed during installation and during the design life of the vertical drain.
- b) The jacket material shall not be subject to localized damage (e.g., punching through the filter by sand/gravel particles).
- c) The jacket material shall be rigid enough to withstand lateral earth pressures due to embedment and surcharge so that the vertical flow capacity through the core will not be adversely affected.
- d) The jacket material shall be flexible enough to bend smoothly during installation and induced consolidation settlement without damage.
- e) The jacket material shall not undergo cracking and peeling during installation of the vertical drain.
- f) The core shall be continuous plastic material fabricated to promote drainage along the axis of the vertical drain. The assembled vertical drain shall be resistant against wet rot, mildew, bacterial action, insects, salts in solution in the ground water, acids, alkalis, solvents, and other ingredients in the site ground water.

4.3 Vertical drain materials shall be labeled or tagged in such a manner that the information for sample identification and other quality control purposes can be read from the label. As a minimum, each roll shall be identified by the manufacturer as to lot or control numbers, individual roll number, date of manufacture, manufacturer and product identification of the jacket and core.

## EXHIBIT 5 - SPECIAL PROVISIONS

During shipment and storage, the vertical drain shall be wrapped in burlap or similar heavy duty protective covering. The vertical drain shall be protected from sunlight, mud, dirt, dust, debris, and other detrimental substances during shipping and on-site storage.

Material which is damaged during shipment, unloading, storage, or handling, or which does not meet the requirements of the drain material will be rejected by the Department. No payment will be made for rejected material.

### 5.0 INSTALLATION

**5.1** Prefabricated vertical drains shall be installed as indicated on the plans or as directed by the Department. The vertical drains shall be installed with equipment that will cause minimum disturbance of the subsoil during installation operations and maintain the mandrel in a vertical position. The vertical drains shall be installed using a mandrel or sleeve that shall be advanced through the soils to the required depth. The mandrel or sleeve shall protect the drain material from tears, cuts, and abrasion during installation and shall be retracted after each vertical drain is installed. To minimize disturbance of the subsoil, the mandrel or sleeve shall have a maximum cross-sectional area of 10 square inches. The mandrel or sleeve shall be sufficiently stiff to prevent wobble or deflection during installation.

**5.2** Constant load or constant rate of advancement methods shall be used. A vibrator shall only be used when approved by the Engineer and the Department in areas where constant load or constant rate of advancement methods cannot install the vertical drains to the design depths. The use of an impact hammer will not be allowed.

**5.3** The vertical drain shall be provided with an "anchor" plate or similar arrangement to anchor the bottom of the drain at the required depth during mandrel removal and to prevent soil from entering the bottom of the mandrel during drain installation. The anchorage shall be adequate to keep the bottom of the vertical drain at the required depth subject to approval and field verification by the Department. The corresponding dimension of the anchor shall conform as closely as possible to the breadth dimensions of the mandrel to minimize soil disturbance. The projected cross-sectional area of the mandrel and anchor combination shall not be greater than 14 square inches.

**5.4** The Contractor shall notify the Department at least 24 hours prior to installation of the initial vertical drains at each embankment location to allow the Department sufficient time to provide the necessary inspection for the initial vertical drain installation. Installation of the initial vertical drains at each area shall not proceed without the presence of the Department's inspector. During the installation of the initial ten vertical drains at each embankment location, the Contractor shall demonstrate that the equipment, method, and material produce a satisfactory installation, as determined by the Department. Following completion of the initial drain installations at each embankment location, the Contractor shall not proceed with the installation of the remaining vertical drains at the embankment location until authorized by the Department.

**5.5** If foundations have been previously installed, the prefabricated vertical drains shall be installed in a manner as to avoid foundations piles or spread footings. The location of the vertical drains relative to the foundations shall be determined and staked out prior to the installation of the prefabricated vertical drains. In addition, the Contractor shall be responsible for taking precautions to preserve the stake locations and is responsible for re-staking, if necessary.

**5.6** Vertical drains shall be located, numbered, and staked out using a baseline and benchmark provided by the Contractor. The Contractor shall be responsible for all other construction staking, for taking precautions to preserve the stake locations, and is responsible for re-staking, if necessary. The as-installed locations of the vertical drains shall not vary by more than six inches from the locations designated on the plans or approved shop drawings.

## EXHIBIT 5 - SPECIAL PROVISIONS

**5.7** Vertical Drains that deviate from the plan locations by more than six inches, that are damaged, or improperly installed will be rejected. Rejected vertical drains shall be abandoned in place. Replacement vertical drains shall be placed as close as possible to the correct original locations.

**5.8** The Contractor shall provide the Department with a means of verifying the plumbness of the mandrel and determining the depth of the vertical drains. The equipment shall be checked for plumbness prior to installing each drain and shall not deviate from the vertical more than two percent (2%) during installation.

**5.9** Splices or connections in the vertical drain material shall be done in accordance with the manufacturer's instructions and in a manner to insure continuity of the vertical drain material. Splicing of vertical drains shall be done by stapling to provide structural and hydraulic continuity of the drain. The jacket and core shall be overlapped a minimum of six inches.

**5.10** Vertical drains shall be installed as shown on the plans and as directed by the Department. The replacement of settlement sensors or plates damaged because of the Contractor's activities will be the responsibility of the Contractor, as described in the Supplemental Specifications for Settlement Sensors or Settlement Plates.

**5.11** Vertical drains shall be installed from the working surface (top of fill soil) to the vertical drain bottom elevations shown on the plans or to refusal in the stratum underlying the compressible stratum. The vertical drains shall penetrate through the compressible stratum, including any granular layers or lenses, and anchored in the underlying stratum. Refusal shall be defined as the point where the soils resist a reasonable effort at further penetration of the vertical drains. The refusal criteria shall be established by the Engineer on the basis of existing soil borings and the initial vertical drain installations to be performed by the Contractor in the presence of the Department's inspector, as specified herein. No vertical drains shall be terminated above the design vertical drain bottom elevations shown on the plans without the approval of the Engineer and the Department. The Engineer may vary the depths, spacing, and/or number of vertical drains to be installed, and may revise the plan limits for this work based on the actual subsurface conditions encountered.

**5.12** The prefabricated vertical drains shall be cut off neatly at least six inches above the working layer, unless otherwise shown on the plans.

**5.13** During vertical drain installation, the Contractor shall provide the Department with a means of determining the depth of the advancing vertical drain at any given time and the length of the drain installed at each location. A summary tabulation of the number and length (to nearest tenth of a foot) of acceptable vertical drains shall be submitted daily to the Department.

**5.14** Where obstructions are encountered below the working surface, the Contractor shall install a new drain within a 1-foot radius of the original location of the obstructed drain. A maximum of two additional attempts shall be made as directed by the Department for each obstructed vertical drain. If the drain still cannot be installed to the design tip elevation, the drain location shall be abandoned and a new drain installed at a location directed by the Department. Locations where vertical drains do not meet the depth criteria due to obstructions shall be clearly marked in the field. The Engineer will have the right to waive the replacement vertical drain requirement upon written notice to the Department and Contractor.

**5.15** Pre-augering or spudding for the vertical drain installation shall be allowed to advance the drains through compacted fill material or other obstructions. The Contractor shall be responsible for penetrating the overlying fill material or any dense layers or obstructions when encountered to satisfactorily install the vertical drains. Satisfactory installation shall allow for clearing obstructions defined as any man-made or natural object or strata that prevents the proper insertion of the mandrel and installation of the vertical drain.

The Contractor may use augering, spudding, or other approved methods to loosen the soil and obstructing material prior to the installation of the drains. The obstruction clearance procedure is subject

## EXHIBIT 5 - SPECIAL PROVISIONS

to the approval of the Engineer and the Department; however, such approval shall not relieve the Contractor of the responsibility to clear obstructions in accordance with the specifications.

If augering is the selected method, the augers shall have a minimum outside diameter equal to the largest horizontal dimension of the mandrel, shoe, or anchor, whichever is greatest. The maximum outside diameter of the auger shall be no more than three inches greater than the maximum dimension of the mandrel.

Obstruction clearance procedures shall be kept to a minimum and shall be used only when approved by the Engineer and the Department. Augering or other obstruction removal techniques shall not penetrate more than two feet into the underlying compressible soil.

Where obstructions are encountered, the following procedure shall be implemented in the listed sequence:

- b) The Contractor shall immediately notify the Department prior to completing the drain and prior to installing other drains.
- c) The Contractor shall then attempt to install drains adjacent to the obstructed location. Based upon the results of these installations and the at the direction of the Department, the Contractor shall:
  1. Attempt to install an offset drain within 1 foot horizontally of the obstructed drain, or
  2. Implement obstruction clearance procedures and install the drain at the design location. Obstruction clearance procedures shall be used only as approved by the Engineer and the Department.

**5.16** Vertical drains shall be installed using a continuous push using either static weight or, when approved by the Engineer and the Department, vibration. Jetting or the use of an impact hammer will not be allowed to install the vertical drains.

**5.17** A mandrel shall be used to protect the vertical drains during installation. The mandrel shall be withdrawn after installation of the vertical drains. In no case will alternative raising and lowering of the mandrel during advancement be permitted. Raising of the mandrel will be permitted only after completion of the vertical drain installation to the bottom of the drain elevation shown on the plans or otherwise authorized by the Engineer and the Department.

### 6.0 MEASUREMENT

**6.1 Vertical Drains:** This item shall include the furnishing of all supervision, equipment, crews, tools, required permits, survey stake out of vertical drain locations, and other equipment and materials as necessary to properly execute the work.

Vertical drains shall be measured to the nearest tenth of a foot. The length of the vertical drains to be paid for shall be the distance the installation mandrel tip penetrates below the working grade plus the required cut-off length above the working surface (top of fill soil). Payment will not be made for drains that are not anchored to the required depth.

No payment will be made for vertical drains placed deeper than the tip elevation designated on the plans unless authorized in writing by the Engineer.

**6.2 Obstructions:** Obstruction clearance by augering or spudding method shall be measured by the linear foot. The length of obstruction clearance to be paid for shall be the length from the working surface at the time of installation to the depth penetrated by the auger or spud, or to a depth two (2) feet into the

**EXHIBIT 5 - SPECIAL PROVISIONS**

underlying compressible soil, whichever is the lesser depth. The obstruction clearance depth is subject to verification by the Department.

Obstruction clearance by other methods shall be measured on a time and materials basis, subject to prior approval of the Department.

**7.0 BASIS OF PAYMENT**

**7.1 Vertical Drains:** Payment for vertical drains shall be made at the contract unit price per linear foot for acceptable drains, which price shall be full compensation for the cost of furnishing the full length of the vertical drain material, installing the vertical drain, altering of the equipment and methods of installation in order to produce the required end result in accordance with the contract documents, and shall also include the cost of furnishing all tools, materials, labor, equipment, supervision, survey stake out of vertical drain locations, an all other costs necessary to complete the required work.

The Engineer may vary the depths, spacing, or numbers of vertical drains to be installed and may revise the vertical drain installation limits shown on the plans based on the actual subsurface conditions encountered. Such changes or revisions may increase or decrease the total quantity of the vertical drains estimated based on the plans. In the event of such changes in required vertical drain quantity, the payment for vertical drains shall be made on the basis of the contract unit price per linear foot.

No payment will be made for vertical drains, or for any delays or expenses incurred through changes necessitated by improper material or equipment.

**7.2 Obstructions:** Payment for obstruction clearance using augering or spudding shall be made at the contract unit price per linear foot, which price shall be full compensation for the cost of preaugering, spudding, or performing other acceptable methods to clear obstruction and to satisfactorily install the vertical drains, including the cost of disposal of any surplus preaugered or obstruction clearance materials. The contract unit price shall include the cost of furnishing all tools, materials, labor, equipment, permits if required, an all other costs necessary to complete the required work.

Payment for the removal of obstructions using methods other than augering or spudding shall be on a time and materials basis as authorized the Department.

Payments shall be made under:

Item No.	Pay Item	Pay Unit
8012300	Prefabricated Vertical Drain with Fabric	LF
8990204	Obstructions	LF

**(82) DIVISION 200: REINFORCED SOIL SLOPES (RSS)**

February 11, 2013

**1.0 Description.** This work shall consist of constructing a reinforced soil slope in accordance with these specifications, plans, or as directed by the RCE and in conformance with the lines, grades, dimensions, and design shown on the plans. The work addressed by this specification includes furnishing and placing of reinforced embankment backfill, placing geosynthetic soil reinforcements (primary and secondary), furnishing secondary soil reinforcement, furnishing and placing topsoil and any associated facing material, and temporary/permanent wire forms (excluding concrete slope protection).



## EXHIBIT 5 - SPECIAL PROVISIONS

**2.0 Responsibility.** The Contractor shall be responsible for the satisfactory construction of the reinforced soil slope feature including materials, methods, and installation based on information provided in the plans, specifications, and the geosynthetic reinforcement supplier's recommendations. The Contractor shall purchase the geosynthetic reinforcement, facing material, geotextile erosion control blankets, sod, fasteners, hold-downs, splice or seaming hardware, wire forms, and all necessary incidentals. The Contractor shall cooperate with the Department in the event that the Department chooses to randomly sample the stock reinforcement geosynthetic reinforcement.

### **3.0 Materials.**

**3.1 Geosynthetic Materials:** The Contractor shall check the geogrid soil reinforcement upon delivery to ensure that the proper material has been received. Geosynthetic rolls shall be labeled per ASTM D 4873, Guide for Identification, Storage, and Handling of Geosynthetic Rolls. During all periods of shipment and storage, the geogrid shall be protected from temperatures greater than 60 C (140 degrees Fahrenheit), mud, dirt, dust, and debris. The manufacturer's recommendations regarding protection from direct sunlight shall be followed. At the time of installation, the geogrid shall be rejected if it has defects, tears, punctures, flaws, deterioration, or damage incurred during manufacture, transportation, or storage. The Contractor, at no additional cost to the Department, shall replace any geosynthetic reinforcement damaged during storage or installation. However, if approved by the RCE, placing a patch over the damaged area may repair torn or punctured sections. Any rejected geosynthetic shall be replaced or repaired at no additional cost to the Department.

For primary and secondary reinforcement, see Special Provision entitled "Geogrid Soil Reinforcement".

For separation of the granitic stone face material and the reinforced soil backfill or for preservation of the RSS, see Special Provision entitled "Geotextile for Separation of Subgrade & Subbase or Base Course Materials", if shown on the plans.

For erosion control reinforcement, see 2007 Standard Specifications, if shown on the plans.

**3.2 Reinforced Backfill Materials:** All backfill material used in the reinforced zone as shown in the plans shall have an internal friction angle equal to or greater than the friction angles specified in the plans for the design. The internal friction angles shall be determined on remolded specimens and shall be determined using either the direct shear (AASHTO T-236) or the triaxial test with pore pressure measurements (AASHTO T-234). The fill materials shall conform to the following gradation limits as determined in accordance with SC T-4 and SC T-5 and shall have a Coefficient of Uniformity,  $C_u$ , of four (4) or greater:

Sieve Size	Percent Passing
¾ inch	100
No. 4	20-100
No. 40	0 - 60
No. 100	0 - 30
No. 200	0 - 15

All reinforced backfill shall have the following soil properties:

1. pH values shall range between 4.5 and 9.0 (AASHTO T-289).
2. Organic content shall not exceed 1.0 percent (weight of organic material to weight of total sample) as determined by AASHTO T-267 for material finer than no. 10 sieve.
3. Internal friction angle shall not be less than the values specified above as determined by the standard direct shear test, AASHTO T-236 or the triaxial test, AASHTO T-234, on the portion finer than

## EXHIBIT 5 - SPECIAL PROVISIONS

the No. 10 sieve. Material test samples shall be compacted to 95% AASHTO T-99 (Method C or D) of maximum density at optimum moisture content.

4. The coefficient of uniformity,  $C_u$ , shall be 4 or greater. The coefficient of uniformity,  $C_u$ , shall be computed as follows:

$$C_u = \frac{D_{60}}{D_{10}}$$

Where  $D_{60}$  is the particle diameter at 60% passing and  $D_{10}$  is the particle diameter at 10% passing.

5. Plasticity Index (PI) shall be less than or equal to 6 and the Liquid Limit (LL) shall be less than or equal to 30 as determined by AASHTO T-90.

**3.3 Testing Frequency:** All soil property requirements shall be tested during initial source evaluation or if a change in source is requested. Reinforced backfill material shall be sampled once every 1,000 cubic yards and tested for gradation, organic content, liquid limit, plasticity index and pH. Reinforced backfill material shall be sampled once every 5,000 cubic yards and tested for internal friction angle. If the coefficient of uniformity,  $C_u$ , of the reinforced backfills is less than 4, the internal friction angle shall be tested every 2,000 cubic yards. A variation in testing frequency may be required if a variation in material gradation or composition is observed.

### 4.0 Construction.

**4.1 Foundation Preparation.** The foundation shall be prepared in accordance with the specifications, except as noted herein or on the plans. Unless otherwise shown on the plans or directed by the RCE, all existing vegetation and all unsuitable foundation materials shall be removed in those areas where the geosynthetic reinforcement is to be used for slope reinforcement.

Foundation soil shall be excavated to the lines and grades as shown on the plans or as directed by the RCE. Over-excavated or muck excavated areas shall be filled with compacted backfill material or as outlined in the special provisions. At the discretion of the RCE, foundation soil shall be proofrolled prior to backfill and geogrid placement.

Where the geosynthetic application is for slope reinforcing on firm foundation soils, the graded area shall also be proofrolled with a vibratory roller weighing a minimum of eight tons for at least five passes in the presence of the RCE or as directed by the RCE. Any soft or loose foundation subsoils, in the opinion of the RCE, incapable of sustaining the required proofrolling shall be removed and replaced in accordance with the specifications.

Surfaces on which reinforcements are to be placed shall be uniform, smooth and free of abrupt changes in slope, debris and irregularities that could damage the reinforcement. Any areas outside the limits of disturbance shown on the plans that are damaged as part of this work shall be promptly repaired and restored to their original condition at the Contractor's expense. The Contractor shall make every possible effort to avoid such damage.

**4.2 Fill Placement:** The moisture content of the backfill material prior to and during compaction shall be approximately uniform throughout each layer of material. Backfill material shall have an in-place moisture content on the dry side of the optimum moisture content. Excessively moist backfill materials shall not be transported to the site for any reason.

The reinforced embankment shall be constructed in accordance with Section 205. Reinforced backfill shall be compacted not less than 95 percent of the maximum dry density in accordance with AASHTO T-99 (Method A or C as applicable) or SC T-25 (Method A or C as applicable). Compaction control testing of the reinforced backfill shall be performed with a minimum frequency of one density test

## EXHIBIT 5 - SPECIAL PROVISIONS

per every two lifts for every 25 feet of reinforced slope at bridge abutments (including the first 150 feet of reinforced slope parallel to the roadway) and every 75 feet of reinforced slopes along roadways (more than 150 feet away from bridge abutments). Sheepsfoot or grid-type rollers shall not be used for compacting backfill within the reinforced backfill.

Backfill shall be placed, spread, and compacted in such a manner that minimizes the development of wrinkles in and/or movement of the geogrid. Tracked construction equipment shall not be operated directly upon the geogrid. A minimum fill thickness of 6 inches is required prior to operation of tracked vehicles over the geogrid. Turning of tracked vehicles should be kept to a minimum to prevent tracks from displacing the fill and damaging the geogrid. Rubber tired equipment may pass over the geogrid reinforcement at slow speeds, less than 10 mph. Sudden braking and sharp turning shall be avoided.

Backfill materials shall have a placement moisture content not more than 2 percentage points below the optimum moisture content and not more than the optimum moisture content. Backfill material with placement moisture content in excess of the optimum moisture content shall be removed and reworked until the moisture content is uniformly acceptable throughout the entire lift.

The maximum soil lift thickness (loose) will be 8 inches. The contractor shall decrease this lift thickness if necessary to obtain the density. Backfill compaction shall be accomplished without disturbance or distortion of the reinforcement. A minimum of 6 inches of backfill material shall be maintained at all times between the contractor's equipment and the soil reinforcement.

At the end of each day's operations, the Contractor shall shape the last level of backfill to permit runoff of rainwater away from the slope face. In addition, the contractor shall not allow surface runoff from adjacent areas to enter the reinforcement zone until this zone is protected from infiltration. Any damage or movement caused by erosion, sloughing, or saturation of the reinforced backfill or retained backfill shall be repaired at the Contractor's expense.

**4.3 Geosynthetic Placement:** Due to the unique nature of this type of construction, the Contractor shall negotiate with the geosynthetic supplier to provide a qualified and experienced representative of the geogrid manufacturer or its supplier for a minimum of one day of site assistance at the start of installation, to assist the Contractor and the RCE in the proper construction/installation techniques. Thereafter, the representative shall be available on an as needed basis, as requested by the RCE, during construction of the remainder of the project. The Contractor shall submit a copy of any instructions provided by the supplier to the RCE prior to beginning installation.

The geosynthetic shall be placed at the proper elevation, location, and orientation as shown on the plans. Geogrid shall be laid at the proper elevation and orientation as shown on the construction drawings or as directed by the RCE. Primary uniaxial strength geogrid shall be oriented perpendicular to the slope face or centerline. Primary biaxial strength geogrid may be laid out either perpendicular to the slope face or parallel to the slope face provided that it is being placed over a stable subgrade (not soft soils). If a biaxial geogrid is being placed over a soft foundation, the geogrid shall be placed perpendicular to the slope face. The Contractor shall verify correct orientation (roll direction) of the geogrid. Geogrid may be temporarily secured in-place with staples, pins, sand bags, or backfill as required by fill properties, fill placement procedures, or weather conditions, or as directed by the RCE. The geosynthetic material shall be pulled tight and secured as necessary to lay flat against the soil prior to fill placement.

Unless otherwise called for on the plans, adjacent rolls of geosynthetic shall be butted together to maintain 100% horizontal coverage. Vertical spacing of the primary soil reinforcing layers shall not exceed the locations shown in the plans.

Primary geogrid shall not be spliced or overlapped in the primary strength direction. No overlapping is required between adjacent rolls of primary soil reinforcement.

**EXHIBIT 5 - SPECIAL PROVISIONS**

Secondary soil reinforcement shall be overlapped a minimum of 12 inches along the roll edges parallel to the reinforcement direction. Overlaps are not allowed for edges perpendicular to the reinforcement direction.

Only that amount of geosynthetic material (including reinforcement and drainage material) required for immediately pending work shall be placed to prevent undue damage to the materials. After a layer of geosynthetic has been placed, the next succeeding layer of soil shall be placed and compacted. After the specified soil layer has been placed and compacted, the next geosynthetic layer shall be installed. The process shall be repeated for each subsequent layer of geosynthetic and soil.

Equipment shall not operate directly on the geosynthetics. Equipment shall be operated such that no turning movements occur on the areas where geosynthetic is in place with less than 12 inches of fill cover. Ruts of more than three inches in depth shall be filled and compacted as they develop.

The Contractor at no additional cost to the Owner shall replace any geogrid damaged during installation.

**5.0 Method of Measurement and Basis of Payment.** The quantity of geosynthetic reinforced slope to be used for payment shall be the area, in square feet, of the vertical projection of the slope face, measured from the top of slope to the proposed final ground line at the toe of the slope and from the beginning to end limits as shown on the plans, regardless of the length or number of layers of geosynthetic within the reinforced volume and including any reinforcement required below the toe of the slope elevation.

The quantity, determined as provided above, shall be paid for at the contract unit price per vertical square foot of geosynthetic reinforced soil slope. Payment shall be full compensation for all work, materials, and services required including, the soil slope secondary reinforcements, placement of reinforced embankment backfill, topsoil, any associated facing material (geotextile for slope preservation), and temporary wire forms (excluding concrete slope protection), installation, testing, and required submittals. The primary geosynthetic reinforcing will be measured and paid for as “Geogrid Reinforcement (Uniaxial)”. The reinforced backfill zone material will be measured and paid for as “Borrow Excavation”. Additional costs associated with using select material within the reinforced backfill zone will be included in the Reinforced Soil Slopes (RSS) item.

**Payment will be made under:**

<b>Item No.</b>	<b>Pay Item</b>	<b>Pay Unit</b>
2061200	Reinforced Soil Slopes (RSS)	SF

**(83) DIVISION 200: MONITORING DEVICES - PIEZOMETER**

Supplemental Specification for Monitoring Devices – Piezometer is revised as follows:

Section 2 Paragraphs 2 and 3 shall be replaced with the following:

“Piezometer shall be installed from the working surface to the depths shown on the plans. These depths refer to the middle of the piezometer referenced to the original ground surface. Enough cable shall be provided to run from the pressure cell to the location of the Vibrating Wire Data Collection Center (VW-DCC) plus 10 feet for each instrument. The cable used to connect the pressure cell to the VW-DCC shall meet the requirements of the instrument manufacturer/supplier. The Contractor shall supply non-conductive conduit to encase the cable between the pressure cell and VW-DCC. The conduit shall have a minimal nominal diameter of 1 inch and meet the requirements of Schedule 80 materials. Provide enough conduit to enclose all lengths of buried cable from the pressure cells to the VW-DCC. All connects in the conduit and in the cable between the pressure cell and VW-DCC shall be water proof.

## EXHIBIT 5 - SPECIAL PROVISIONS

During roadway construction and any delay period for settlement, the piezometers will be read and analyzed by the Engineer at the same times outlined in the Special Provision for Settlement Plates. If the piezometers indicate excessive excess pore pressures at a given location during embankment placement operations, the placing of embankment material shall be suspended.”

The following shall be added to the end of Section 2 Paragraph 4:

“Figure 1 depicts the installation of a single piezometer in a borehole; however, multiple piezometers may be placed in the same borehole. The installation of multiple piezometers is not shown for clarity.”

Section 4 Paragraph1 shall be replaced with the following:

Unit price bid for "Monitoring Devices-Piezometer" shall include all costs associated with supplying, installing, and maintaining the monitoring devices. The Contractor will monitor the devices throughout construction of the embankment and for up to a period of one year after the final delay period for settlement when embankment construction is completed. The Contractor will be responsible for ensuring the piezometers are in working order and accessible once the embankment is complete.”

### **(84) DIVISION 200: SETTLEMENT SENSORS**

#### 1.0 GENERAL

#### 3.2 Scope

The work under this Section consists of furnishing all supervision, labor, material, equipment, and related services necessary to furnish and install settlement sensors as indicated on the Drawings and specified herein. The Contractor shall accommodate the Engineer in the monitoring of settlement sensors.

The purpose of the settlement-monitoring program is to:

3. Confirm estimates of the time rate of settlement of embankments and retaining walls during construction so that construction methods may be adjusted, if necessary, to meet the project schedule;
4. Confirm that settlement is sufficiently completed prior to final grading and paving of roadways supported on embankments and retaining walls.

Consolidation settlement of the foundation soils is expected to occur during and for a period after construction of new embankments and retaining walls. The magnitude and rate of the settlement will depend on the variation of the stratigraphy and consolidation properties of the foundation soils. To effectively manage the post-construction settlement, settlement sensors shall be used to monitor the magnitude and rate of settlement during construction.

Settlement sensors shall be furnished and installed by the Contractor in the presence of the Engineer and the Department. Settlement sensors shall consist of a steel plate with the attached sensor equipment designed to be buried within soil fill and connected to a liquid reservoir, which is set in stable ground that is not subject to settlement. Settlement measurements are referenced to the fluid level of the reservoir supported on stable ground.

#### 3.3 Responsibilities of Contractor:

## EXHIBIT 5 - SPECIAL PROVISIONS

The Contractor shall notify the Engineer and the Department at least five (5) working days prior to the installation of settlement sensors.

The Contractor shall furnish and install the settlement sensors in the presence of the Engineer and the Department.

The Contractor shall provide a licensed surveyor to stake out and provide as-built locations and elevations of all settlement sensors and liquid reservoir locations.

The Contractor shall protect the settlement sensors and liquid reservoirs from damage for the duration of the Contract.

The Contractor shall provide the Engineer and the Department safe access to the settlement sensors for the purpose of data collection for the duration of the Contract.

The Contractor shall be responsible for locating all settlement sensors in the field and ensuring that no conflicts exist between settlement sensors, liquid reservoir locations and existing and proposed structures, utilities or other construction proposed or present at the site.

### 3.4 Site Preparation

The Contractor shall ensure a firm base on which heavy equipment and/or other necessary equipment can be operated safely under its own power for installation of settlement sensors.

The Contractor shall accurately locate all settlement sensors in accordance with Drawings. Settlement sensors shall be adjusted by the Contractor, with the approval of the Engineer and the Department, to avoid utilities, foundations, and all other underground construction.

### 3.5 Existing Soil Conditions:

The subsurface conditions encountered at the site are presented in the Contract Plans and documents.

## 2.0 PRODUCTS

### 2.1 Settlement Sensor

The settlement sensor shall consist of a 12-in. square, ¼-in. thick steel plate with an attached vibrating wire pressure sensor. A liquid reservoir and readout panel shall also be supplied in a waterproof casing. The Contractor shall supply weather resistant locks and keys for the casings. The Contractor shall provide all keys to the Engineer and the Department. The liquid reservoir shall have a graduated scale attached so that the liquid level can be checked visually. The manufacturer's instruction and installation manual shall be supplied with the settlement sensor. The sensor shall have the signal cable and tubing attached and factory saturated with a 50% ethylene glycol antifreeze solution, ready for connection to the readout panel and liquid reservoir. The liquid reservoir shall have two tubing connections to the sensor to allow for flushing if necessary. Additional antifreeze solution shall be provided to fill the liquid reservoir and saturate the tubing connections. The vibrating wire pressure sensor shall be self-compensated for variations in barometric pressure, and have a built in temperature sensor for correction of temperature variations. The vibrating wire sensor shall be vented to the air space at the top of the liquid reservoir to accomplish the self-compensation for barometric pressure, and a moisture trap shall be included in series with the vent tubing. The settlement sensor shall have a minimum range of 5 ft, a resolution of 0.01 ft, and a system accuracy of ±0.02 ft.

Settlement sensor model 4650 manufactured by Geokon, Inc. of Lebanon, NH, or equivalent,

## EXHIBIT 5 - SPECIAL PROVISIONS

shall be supplied. Catalog sheet for 4650 Settlement sensor is attached at the end of this specification for reference.

### 2.2 Support Post

A metal or wooden post shall be provided for mounting the liquid reservoir and readout panel. The post shall be long enough so that it can be set a minimum of 3-ft below the stable ground surface, and the readout panel will be mounted no less than 2-ft off of the ground.

### 2.3 Sand Backfill

Clean sand backfill with no particles larger than 3/8-in. shall be provided to backfill around the signal cable and tubing leading from the settlement plate to the liquid reservoir and readout panel.

### 2.4 Incidentals

Incidental conduit, hardware, fasteners, tools, electronic readouts and the like, as necessary to install the system in accordance with the manufacturer's manual, shall be provided.

## 3.0 SUBMITTALS

The Contractor shall submit the Specification sheet for the settlement sensor prior to purchase of settlement sensor for review and approval of the Engineer **and the Department**. Locations for the liquid reservoir shall also be submitted for approval, so that the proper length of signal cable and tubing can be purchased.

Upon receipt of the settlement sensor, the Contractor shall submit copies of calibration sheets and the manufacture's installation and instruction manual for review and approval of the Engineer **and the Department**, and shall make available the settlement sensor for inspection by the Engineer.

Within 1 week following installation, the contractor shall submit an installation record for each settlement plate which includes the plate designation, station, offset, and elevation of the Settlement sensor, and station offset and elevation of the liquid reservoir. The settlement sensor shall be located to an accuracy of 0.01 ft (both vertically and horizontally).

## 4.0 EXECUTION

### 4.1 Settlement Sensor Installation

The Contractor shall furnish and install settlement sensors in accordance with the Drawings and these specifications and in the presence of the Engineer **and the Department**. Settlement sensors shall be installed prior to embankment or retaining wall construction and following installation of wick drains, stone columns, or other ground improvement, and grubbing and clearing in the immediate vicinity of each settlement plate. Settlement sensor locations shall be adjusted by the Contractor only with the approval of the Engineer **and the Department**.

Settlement sensor installation shall be in accordance with the manufacturer's recommendations as presented in their instruction and installation manual. The liquid reservoir shall be located clear of the construction area, in an area where no fill will be placed and no settlement is anticipated. The liquid reservoir and readout panel shall not be located in drainage swales, storm water detention ponds or other areas where the panel may become submerged. A licensed surveyor shall provide a survey of the installed sensor and liquid reservoir. The survey reference point for the liquid reservoir and readout panel shall be permanently marked so that subsequent surveys may be referenced to this mark.

**EXHIBIT 5 - SPECIAL PROVISIONS**

4.2 Allowance for Settlement Sensor Monitoring

The contractor shall accommodate the Engineer **and the Department** during construction to provide safe and timely access to settlement sensors for the purpose of obtaining measurements, as construction progresses. Evaluation of the settlement sensor data will be the responsibility of the Engineer **and the Department**.

4.3 Fill Height Survey and Liquid Reservoir Survey

The Contractor shall make a survey of the ground surface elevation above each settlement sensor twice weekly while fill is being placed, and **once every two weeks** when fill is not being placed, unless directed otherwise by the Engineer **and the Department**. The purpose of these measurements is to provide the Engineer with a time-history of the embankment or retaining wall height for correlation with settlement measurements. Survey of the liquid reservoir and readout panel elevation shall be made every four weeks, or if disturbance of the liquid reservoir is suspected, or as directed by the Engineer **or the Department**. Surveys made by the Contractor shall be provided to the Engineer **and the Department** within one week.

4.4 Protection of Settlement Sensors

The Contractor shall protect settlement sensors from damage and vandalism for the duration of the Contract and repair or replace damaged or inoperative settlement sensors at no cost to the Department.

4.5 Abandonment of Settlement Sensors

Once the Engineer **and the Department** has determined that the settlement sensors have served their purpose and are no longer needed, they shall be abandoned in-place. The Contractor shall remove recoverable portions of the settlement sensor, likely consisting of only the liquid reservoir and readout panel. All recoverable instrumentation shall remain property of the Contractor. The Contractor shall remove the ethylene glycol antifreeze solution from the buried tubing that is left in place by use of either a vacuum pump or by blowing out the tubing with air pressure. The antifreeze solution shall be contained and disposed of offsite in a proper manner by the Contractor.

5.0 METHOD OF MEASUREMENT

The number of settlement sensors, as provided in the plans, will be paid for at the contract unit price bid for "Monitoring Device - Settlement Sensors" which shall include all equipment, including but not limited to the settlement sensor, liquid reservoir, water proof casing; mobilization; labor; surveys; materials; incidentals and abandonment required by these Specifications.

6.0 BASIS OF PAYMENT

The price and payment for this work shall be full compensation for furnishing the necessary Settlement Sensor, including the settlement sensor, the liquid reservoir, the waterproof casing, surveys and incidental items based on the acceptance of the Settlement Sensor installation by the Engineer.

**Payments shall be made under:**

<b>Item No.</b>	<b>Pay Item</b>	<b>Pay Unit</b>
2038115	MON. DEVICE – SETTLEMENT SENSOR	EA



## EXHIBIT 5 - SPECIAL PROVISIONS

### Model 4650 Settlement System



● Model 4650 Settlement System.

#### Applications

The Model 4650 is designed for remote measurement of the settlement of a point in or below fills, surcharges, embankments, etc. Systems with tube lengths of up to 300 m have been used successfully to measure settlements in earth dam embankments.

#### Operating Principle

A vibrating wire pressure sensor is attached to a settlement plate located at the point of settlement. The sensor is connected via two liquid-filled tubes, extending laterally, to a reservoir located on stable ground. The sensor measures the hydraulic head of liquid between the sensor and reservoir locations.

#### Advantages and Limitations

A vented cable runs from the sensor to the remote readout location and connects to the reservoir so that barometric pressure fluctuations do not affect the readings.

The liquid-filled tubes can be flushed to remove any air bubbles that might form.

It is possible to perform in-situ checks at any time on both the calibration and zero stability.

#### Technical Specifications

Standard Ranges <sup>1</sup>	7, 17 m (20, 50 ft.)
Resolution/Sensitivity	2, 4 mm (0.08, 0.16 in.)
System Accuracy <sup>2</sup>	±4 to ±6 mm (±0.16 to ±0.24 in.)
Temperature Range <sup>1</sup>	-20°C to +80°C

<sup>1</sup>Other ranges available on request.  
<sup>2</sup>Sensor accuracy 0.1% F.S.

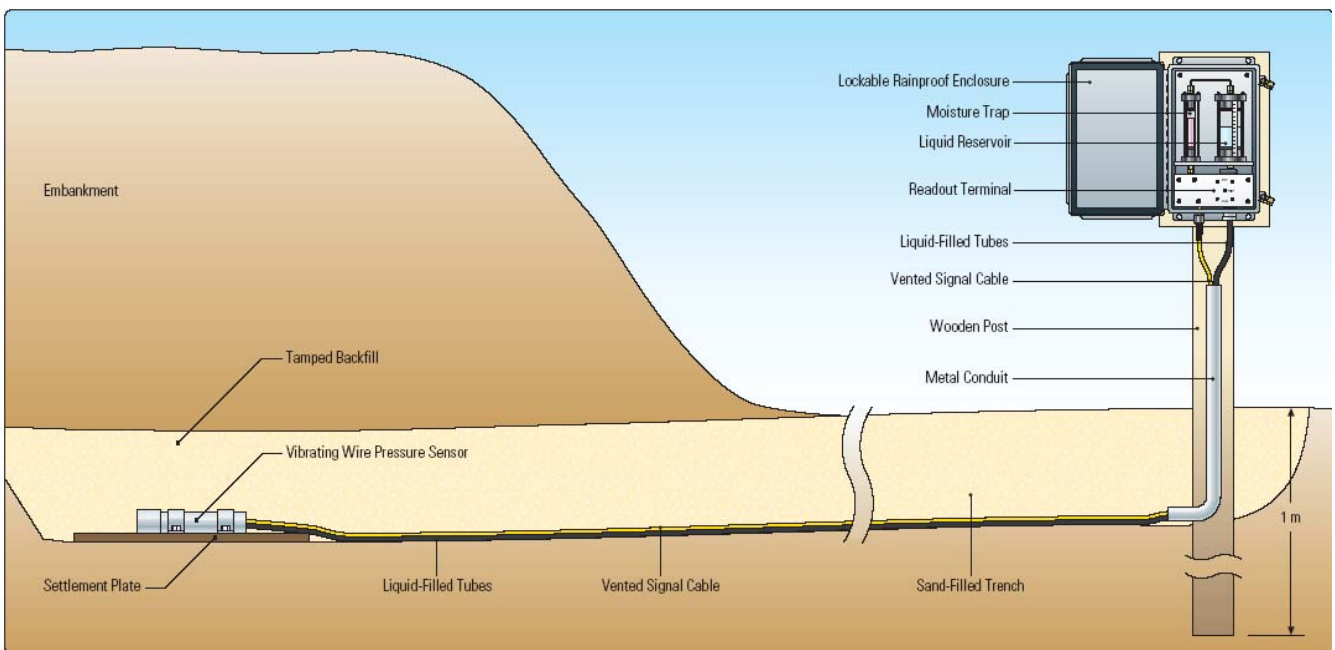

● Model 4650 installation for the remote measurement of subsurface settlement beneath a large embankment.

**(85) DIVISION 200: TOTAL PRESSURE CELLS**

**1.0 Description.** This work includes furnishing all supervision, materials, equipment, labor, and related services necessary for installing pressure monitoring instrumentation consisting of a vibrating wire (VW) total (earth) pressure cell at the locations indicated in the plans and in accordance with these specifications. This item includes the furnishing of as-built drawings of actual locations where instrumentation was installed, survey data recorded during instrumentation installation, and installation field reports. Also included in this item of work is the initial and periodic/continuous recording of total pressure readings and reporting to the Engineer and the Department in accordance with the Department's Geotechnical Instrumentation Monitoring Plan for the entire duration of the project.

The purpose of the instrumentation monitoring program is to:

5. Confirm estimates of load transfer to the stone columns beneath the column supported embankment;
6. Confirm that the soil located between the stone columns does not carry excessive loads that could induce consolidation settlement, thus affecting the performance of the bridge foundations.

The Contractor shall be familiar with project geotechnical conditions and recognize that geotechnical data is available with geotechnical boring logs, laboratory testing results, and other pertinent information.

**2.0 Pressure Instrumentation.** VW total (earth) pressure cell shall consist of 2 steel plates welded at the edges with an incompressible fluid filled void located between the plates. The void between the plates shall be hermetically sealed. The incompressible fluid shall be in contact with a pressure transducer that converts the pressure into an electronic signal that is recorded by the data collection unit outside of the embankment. The pressure cell shall be able to measure up to 50 psi and shall be designed to withstand point loads induced by stone of the stone columns and the load transfer platform on both sides. The aspect ratio ( $D/t$  –  $D$  - diameter of cell;  $t$  – thickness of cell) of the cell shall be greater than 15. The pressures cells shall have an accuracy  $\pm 0.1$  percent with a thermal affect of  $<0.05$  percent for a temperature range of  $-4^{\circ}\text{F}$  to  $176^{\circ}\text{F}$ . Enough cable shall be provided to run from the pressure cell to the location of the Vibrating Wire Data Collection Center (VW-DCC) plus 10 feet for each instrument. The cable used to connect the pressure cell to the VW-DCC shall meet the requirements of the instrument manufacturer/supplier. The Contractor shall supply non-conductive conduit to encase the cable between the pressure cell and VW-DCC. The conduit shall have a minimal nominal diameter of 1 inch and meet the requirements of Schedule 80 materials. Provide enough conduit to enclose all lengths of buried cable from the pressure cells to the VW-DCC. All connections in the conduit and in the cable between the pressure cell and VW-DCC shall be water proof.

**3.0 Submittals.** Within 30 calendar days before installing the total pressure cells, the Contractor shall submit to the Department for review the qualifications of the personnel installing the instrumentation as well as the installation plan. The submittals shall contain as a minimum the following information.

**3.1 Qualifications:** The Contractor shall identify the licensed surveyor who shall be responsible for providing survey services during the installation of the total pressure cell. The Contractor shall also identify the geotechnical engineer that will be responsible for installing the total pressure cell in accordance with the Department's Geotechnical Instrumentation Monitoring Plan. The geotechnical engineer's experience in providing instrumentation services using a total pressure cell and remote VW-DCC in accordance with the plans and Contract Documents shall be documented by providing a project summary, of at least three projects, that includes for each project the project name, role in providing instrumentation services, type of total pressure cell and VW datalogging equipment used, duration of the project (i.e. dates), magnitude of settlements, client name and address, name and phone number of representative of the consultant and owner for whom the work was performed and can attest to the successful completion of the work, and any other information relevant to demonstrating the geotechnical engineer's qualifications. In addition, the manufacturer/supplier shall also be on-site during the initial installation of the total pressure cells to ascertain that all instruments have been connected correctly. The manufacturer/supplier shall also be available for questions from either the geotechnical engineer

## EXHIBIT 5 - SPECIAL PROVISIONS

responsible for maintaining the total pressure cells or from the Department concerning the data being collected.

**3.2 Installation Plan:** The proposed total pressure cell installation plan shall include as a minimum the following information:

1. The Contractor shall submit the Specification sheet for the proposed total pressure cell system prior to purchase for review and approval of the Engineer and the Department.
2. Submit locations where the total pressure cells will be installed for approval. The location should indicate the number of the stone column that the total pressure cell will be located on or the numbers of the surrounding stone columns for the total pressure cell located between stone columns.
3. Proposed installation method of total pressure cell.
4. Proposed method to protect total pressure cell and cable during construction from construction equipment and vandalism.

**3.3 Submittal Reviews:** Approval of the personnel qualifications and installation plan by the Department shall not relieve the Contractor of its responsibility to successfully install the total pressure cells in accordance with the plans and specifications. Approval by the Department of the total pressure cell installation and instrumentation plan shall be contingent upon satisfactory demonstration that the instrumentation is meeting the objectives of the Department's Geotechnical Instrumentation Monitoring Plan. If, at any time, the Department or the Engineer considers that the method of installation or monitoring does not produce satisfactory results, the Contractor shall alter the method and/or equipment as necessary to comply with the Special Provisions and Department's Geotechnical Instrumentation Monitoring Plan. The Department will be the sole judge in determining the adequacy of the Contractor's installation and monitoring results and whether monitoring can be discontinued.

**4.0 Delivery, Storage, and Handling.** The Contractor shall check all materials and equipment upon delivery to ensure that the proper items are received and are not damaged. All materials shall be stored and maintained in a clean, uncontaminated condition throughout the course of the project. Upon receipt of the total pressure cells, the Contractor shall submit copies of the manufacturer's installation and instruction manual for review and approval by the Engineer and the Department, and shall make available the data logging system for inspection by the Engineer and the Department.

**5.0 Total Pressure Cell Installation.** Upon receipt of the total pressure cell, the Contractor shall submit copies of calibration sheets and the manufacturer's installation and instruction manual for review and approval by the Engineer and the Department, and shall make available the pressure cell for inspection by the Engineer and the Department.

The Contractor shall notify the Engineer and the Department at least fourteen (14) days prior to the installation of total pressure cells. Total pressure cells shall be furnished and installed by the Contractor in accordance with the plans and this specification and in the presence of the Engineer and the Department.

The Contractor shall be responsible for locating all total pressure cells in the field and ensuring that no conflicts exist between total pressure cells and foundations, structures, utilities or other construction proposed or present at the site.

The Contractor shall provide a licensed surveyor to stake out and provide as-built locations and elevations of all total pressure cells locations.

Total pressure cells shall be installed prior to construction of the load transfer platform and embankment construction and following installation of the stone columns. The Contractor shall ensure a firm base on which heavy equipment and/or other necessary equipment can be operated safely under its own power for installation of total pressure cells.

**EXHIBIT 5 - SPECIAL PROVISIONS**

Total pressure cell installation shall be in accordance with the manufacturer's recommendations as presented in their instruction and installation manual. The total pressure cell will be connected to the VW-DCC in accordance with the plans, contract documents, and manufacturer's recommendations.

The Contractor shall accurately locate all total pressure cells in accordance with plans. Total pressure cells may be adjusted by the Contractor, with the approval of the Engineer, to avoid utilities, foundations, and all other underground construction.

Within 1 week following installation, the contractor shall submit an installation record for each total pressure cell, which includes the instrumentation identification as provided in the plans, station/alignment, offset, and elevation of the total pressure cell. The total pressure cell shall be located to an accuracy of 0.01 ft (both vertically and horizontally).

The Contractor shall protect total pressure cell locations from damage and vandalism for the duration of the Contract and repair or replace damaged or inoperative total pressure cells at no cost to the Department.

**6.0 Abandonment of Total Pressure Cells.** Once the Engineer and the Department has determined that the total pressure cells have served their purpose and are no longer needed, the total pressure cells shall be abandoned in-place. The Contractor shall remove recoverable portions of the total pressure cell. All recoverable instrumentation shall remain property of the Contractor. The Contractor shall remove no more than 2 feet of the conduit that extends into the embankment and shall seal the conduit left in place within the embankment using a lean grout mix.

**7.0 Method of Measurement.** The number of total pressure cells, as provided in the plans, will be paid for at the contract unit price bid for "Monitoring Device – Total Pressure Cells" which shall include all equipment, including but not limited to the total pressure cell, water proof casing; mobilization; labor; surveys; materials; incidentals and abandonment required by these Specifications along with total pressure cell data as outlined in the Geotechnical Instrumentation and Monitoring Plan. Payment will not be made for total pressure cells that malfunction or are rejected for their inability to perform, or do not meet the requirements in the plans and these specifications.

**8.0 Basis of Payment.** The price and payment for this work shall be full compensation for furnishing the necessary Total Pressure Cell, including the total pressure cell, the waterproof casing, surveys, data as outlined in the Geotechnical Instrumentation and Monitoring Plan, and incidental items based on the acceptance of the Total Pressure Cell installation by the Engineer.

**Payments shall be made under:**

Item No.	Pay Item	Pay Unit
2038108	MON. DEVICE – TOTAL PRESSURE CELL	EA

**(86) DIVISION 200: VIBRATING WIRE DATA COLLECTION CENTERS**

February 23, 2012

**1.0 Description.** This work includes furnishing all supervision, materials, equipment, and labor, and related services necessary for providing and maintaining a Vibrating Wire Data Collection Center (VW-DCC) at the locations indicated in the plans and in accordance with these specifications. This work consists of automating the data collection for vibrating wire rod extensometers and piezometers with a real-time system that is accessible via the internet in accordance with the Department's Geotechnical Instrumentation Monitoring Plan for the entire duration of the project as determined necessary for evaluating the settlement instrumentation of the embankments being constructed.

**2.0 Vibrating Wire Data Collection Center.** The Vibrating Wire Data Collection Centers (VW-DCC) is an automated centralized vibrating wire data collection center. The VW-DCC will be used to collect

## EXHIBIT 5 - SPECIAL PROVISIONS

vibrating wire rod extensometer (VWRE) and piezometer (PZ) readings. Temperature readings shall also be collected when instrumentation contains thermistors. The automated collection of VW data shall be accomplished by using a data logging system that is sufficiently capable to monitor the VW sensors indicated in the plans and with the capability of adding four additional rod extensometers and six piezometers to the system. Sufficient ports shall be provided to also monitor temperature. The reserve instrumentation monitoring capacity can be either achieved by using a data logging system with sufficient ports or by having the capability to expand the system if needed. The Contractor shall maintain compatibility between the data logging system and the rod extensometers and piezometer instrumentation. In order to maintain compatibility of the systems and be able to get technical assistance from the manufacturer during installation and throughout the project the VW-DCC system should be supplied/manufactured by the same company that is supplying the rod extensometer and piezometer instrumentation. In addition, the VW-DCC shall have the following features:

Data logging system with sufficient capacity to read and save instrumentation readings.

The data logging system shall have the reserve capacity to add additional instrumentation if needed.

Powered by on-site AC current

Battery power back-up with surge suppression

Telephone/cellular access for transmitting data through the internet

Dedicated server for storing and running viewing software.

On-line instrumentation software for reviewing/downloading instrumentation data

Enclosure that protects the equipment from damage during construction, vandalism, and weather.

**3.0 Submittals.** Within 30 calendar days before installing the VW-DCC, the Contractor shall submit to the Department for review the personnel qualification, installation plan, and monitoring plan. The submittals shall contain as a minimum the following information.

**3.1 Qualifications:** The Contractor shall identify the geotechnical engineer that will be responsible for installing and maintaining the VW Data Collection Center. The same geotechnical engineer that is responsible for the vibrating wire rod extensometers and piezometers will also be responsible for the VW-DCC. The geotechnical engineer's experience in providing automated data logging capabilities such as the VW-DCC in accordance with the plans and Contract Documents shall be documented by providing a project summary, of at least three projects, that includes for each project the project name, role in providing instrumentation services, type of data logging system, equipment used, duration of the project (i.e. dates), client name and address, name and phone number of representative of the consultant and owner for whom the work was performed and can attest to the successful completion of the work, and any other information relevant to demonstrating the geotechnical engineer's qualifications. In addition, the manufacturer/supplier shall also be on-site during the initial installation of the VW-DCC to ascertain that all instruments have been connected correctly. The manufacturer/supplier shall also be available for questions from either the geotechnical engineer responsible for maintaining the VW-DCC or from the Department concerning the data being collected.

**3.2 Installation Plan:** The installation plan shall include as a minimum the following information:

The Contractor shall submit the Specification sheet for the proposed VW-DCC system for review and approval by the Engineer and the Department.

Submit locations where VW-DCC will be installed.

Proposed installation method.

Proposed method to protect VW-DCC during construction from construction equipment, vandalism, weather.

**3.3 Submittal Reviews:** Approval of the personnel qualification and installation plan by the Department shall not relieve the Contractor of its responsibility to successfully install the VW rod extensometers and VW piezometers and monitor this instrumentation with VW-DCC in accordance with the plans and specifications. Approval by the Department of the VW-DCC installation plan shall be contingent upon satisfactory demonstration that the VW-DCC is meeting the objectives of the Department's Geotechnical Instrumentation Monitoring Plan. If, at any time, the Department or the Engineer considers that the VW-DCC does not produce satisfactory results, the Contractor shall alter the method and/or equipment

**EXHIBIT 5 - SPECIAL PROVISIONS**

as necessary to comply with the Special Provisions and Department's Instrumentation Plan. The Department will be the sole judge in determining the adequacy of the Contractor's VW-DCC.

**4.0 Delivery, Storage, and Handling.** The Contractor shall check all materials and equipment upon delivery to ensure that the proper items are received and are not damaged. All materials shall be stored and maintained in a clean, uncontaminated condition throughout the course of the project. Upon receipt of the VW-DCC, the Contractor shall submit copies of the manufacture's installation and instruction manual for review and approval by the **and the Department**, and shall make available the data logging system for inspection by the Engineer **and the Department**.

**5.0 Abandonment of VW-DCC.** Once the Engineer **and the Department** has determined that VW-DCC systems have served their purpose and are no longer needed, the VW-DCC shall be abandoned by removing all equipment and signal wires a minimum of 2 feet of ground surface.

**6.0 Method of Measurement.** The number of VW-DCC provided in the plans, will be paid for at the contract unit price bid for "Vibrating Wire Data Collection Center" which shall include, but not limited to, all labor, materials, and equipment necessary to install a vibrating wire data collection center. Payment will not be made for VW-DCC that malfunction or are rejected for their inability to perform, or do not meet the requirements in the plans and these specifications.

**7.0 Basis of Payment.** The price and payment for this work shall be full compensation for furnishing the necessary data logging system, enclosure, protection from vandalism and construction equipment, and incidental items based on the successful implementation of the VW-DCC system.

**Payments shall be made under:**

<b>Item No.</b>	<b>Pay Item</b>	<b>Pay Unit</b>
8990440	VW Data Collection Center	EA

**(87) DIVISION 200: VIBRATING WIRE ROD EXTENSOMETER**

**1.0 Description.** This work includes furnishing all supervision, materials, equipment, labor, and related services necessary for providing, installing and maintaining a Vibrating Wire Rod Extensometer (VWRE) at the locations indicated in the plans and in accordance with these specifications. This item includes the furnishing of as-built drawings of actual locations where instrumentation was installed, survey data recorded during instrumentation installation, and installation field reports. Also included in this item of work is the initial and periodic/continuous recording of VWRE readings and reporting to the Engineer **and the Department** in accordance with the **Department's** Geotechnical Instrumentation Monitoring Plan for the entire duration of the project.

The purpose of the instrumentation monitoring program is to monitor settlement of the approach embankments.

The Contractor shall be familiar with project geotechnical conditions and recognize that geotechnical data is available with geotechnical boring logs, laboratory testing results, and other pertinent information.

**2.0 Vibrating Wire Rod Extensometer.** The Vibrating Wire Rod Extensometer is an automated device for monitoring settlement. The VWRE shall contain 6 rod extensometers that will measure settlement at different depths below the ground surface. The depths of data collection are indicated in the project plans. The rod extensometers will be housed in a casing of sufficient diameter to allow for 6 rods in each casing. The VWRE shall be capable of measuring settlements of 18 inches. The VWRE shall have an accuracy  $\pm 0.1$  percent with a thermal effect of  $< 0.05$  percent for a temperature range of  $-4^{\circ}\text{F}$  to  $176^{\circ}\text{F}$ . In

## EXHIBIT 5 - SPECIAL PROVISIONS

addition, the VWRE shall have a long-term stability of <0.2 percent per year. The location of each rod extensometer cluster is indicated in the project plans. Each rod extensometer cluster will be connected to a data collection center. The cluster shall be installed in accordance with the manufacturer's recommendations. Each VWRE cluster shall be connected to the data collection center either via cable or via cellular communications. If cable is used, enough cable shall be provided to run from the VWRE to the location of the Vibrating Wire Data Collection Center (VW-DCC) plus 10 feet for each instrument. The cable used to connect the VWRE to the VW-DCC shall meet the requirements of the instrument manufacturer/supplier. The Contractor shall supply non-conductive conduit to encase the cable between the VWRE and VW-DCC. The conduit shall have a minimal nominal diameter of 1 inch and meet the requirements of Schedule 80 materials. Provide enough conduit to enclose all lengths of buried cable from the VWRE to the VW-DCC. All connections in the conduit and in the cable between the VWRE and VW-DCC shall be water proof.

**3.0 Submittals.** Within 30 calendar days before installing the VWRE, the Contractor shall submit to the Department for review the personnel qualification, installation plan, and monitoring plan. The submittals shall contain as a minimum the following information.

**3.1 Qualifications:** The Contractor shall identify the licensed surveyor who shall be responsible for providing survey services during the installation of the VWRE. The Contractor shall identify the geotechnical engineer that will be responsible for installing and maintaining the VWRE. The same geotechnical engineer that is responsible for the VW-DCC and piezometers will also be responsible for the VWRE. The geotechnical engineer's experience in installing VWRE in accordance with the plans and Contract Documents shall be documented by providing a project summary, of at least three projects, that includes for each project the project name, role in providing instrumentation services, type of VWRE, equipment used, duration of the project (i.e. dates), magnitude of settlements, client name and address, name and phone number of representative of the consultant and owner for whom the work was performed and can attest to the successful completion of the work, and any other information relevant to demonstrating the geotechnical engineer's qualifications. In addition, the manufacturer/supplier shall also be on-site during the initial installation of the VWRE to ascertain that all instruments have been connected correctly. The manufacturer/supplier shall also be available for questions from either the geotechnical engineer responsible for maintaining the VWRE or from the Department concerning the data being collected.

**3.2 Installation Plan:** The installation plan shall include as a minimum the following information:

5. The Contractor shall submit the Specification sheet for the proposed VWRE system for review and approval by the Engineer and the Department.
6. Submit locations where VWRE will be installed if different from the location shown on the plans.
7. Proposed installation method.
8. Proposed method to protect VWRE during construction from construction equipment, vandalism, weather.

**3.3 Submittal Reviews:** Approval of the personnel qualification and installation plan by the Department shall not relieve the Contractor of its responsibility to successfully install the VWREs in accordance with the plans and specifications. Approval by the Department of the VWRE installation plan shall be contingent upon satisfactory demonstration that the VWRE is meeting the objectives of the Department's Geotechnical Instrumentation Monitoring Plan. If, at any time, the Department or the Engineer considers that the VWRE does not produce satisfactory results, the Contractor shall alter the method and/or equipment as necessary to comply with the Special Provisions and Department's Instrumentation Plan. The Department will be the sole judge in determining the adequacy of the Contractor's VWRE.

**4.0 Delivery, Storage, and Handling.** The Contractor shall check all materials and equipment upon delivery to ensure that the proper items are received and are not damaged. All materials shall be stored and maintained in a clean, uncontaminated condition throughout the course of the project. Upon receipt of the VWRE, the Contractor shall submit copies of the manufacture's installation and instruction manual for

## EXHIBIT 5 - SPECIAL PROVISIONS

review and approval by the **and the Department**, and shall make available the data logging system for inspection by the Engineer **and the Department**.

**5.0 VWRE Installation.** Upon receipt of the VWRE, the Contractor shall submit copies of calibration sheets and the manufacturer's installation and instruction manual for review and approval by the Engineer **and the Department**, and shall make available the VWRE for inspection by the Engineer **and the Department**.

The Contractor shall notify the Engineer **and the Department** at least fourteen (14) days prior to the installation of VWRE. The VWREs shall be furnished and installed by the Contractor in accordance with the plans and this specification and in the presence of the Engineer **and the Department**.

The Contractor shall be responsible for locating all VWREs in the field and ensuring that no conflicts exist between VWREs and foundations, structures, utilities or other construction proposed or present at the site.

The Contractor shall provide a licensed surveyor to stake out and provide as-built locations and elevations of all VWREs locations.

VWREs shall be installed prior to construction of the embankment. VWRE installation shall be in accordance with the manufacturer's recommendations as presented in their instruction and installation manual. The VWRE will be connected to the VW-DCC in accordance with the plans, contract documents, and manufacturer's recommendations.

The Contractor shall accurately locate all VWREs in accordance with the plans. VWREs may be adjusted by the Contractor, with the approval of the Engineer **and the Department**, to avoid utilities, foundations, and all other underground construction.

Within 1 week following installation, the contractor shall submit an installation record for each VWRE, which includes the instrumentation identification as provided in the plans, station/alignment, offset, and elevation. The VWRE shall be located to an accuracy of 0.01 ft (both vertically and horizontally).

The Contractor shall protect VWRE locations from damage and vandalism for the duration of the Contract and repair or replace damaged or inoperative VWREs at no cost to the Department.

**6.0 Abandonment of VWRE.** Once the Engineer **and the Department** has determined that the VWRE systems have served their purpose and are no longer needed, the VWRE systems shall be abandoned in-place. The Contractor shall remove recoverable portions of the VWRE. All recoverable instrumentation shall remain property of the Contractor. The Contractor shall remove no more than 2 feet of the conduit that extends into the embankment and shall seal the conduit left in place within the embankment using a lean grout mix.

**7.0 Method of Measurement.** The number of VWRE provided in the plans, will be paid for at the contract unit price bid for "Vibrating Wire Rod Extensometer" which shall include all equipment, including but not limited to the VWRE, water proof casing; mobilization; labor; surveys; materials; incidentals and abandonment required by these Specifications along with VWRE data as outlined in the Geotechnical Instrumentation and Monitoring Plan. Payment will not be made for VWRE that malfunction or are rejected for their inability to perform, or do not meet the requirements in the plans and these specifications.

**8.0 Basis of Payment.** The price and payment for this work shall be full compensation for furnishing the necessary data logging system, enclosure, protection from vandalism and construction equipment, data as outlined in the Geotechnical Instrumentation and Monitoring Plan, and incidental items based on the successful implementation of the VWRE system.



**EXHIBIT 5 - SPECIAL PROVISIONS**

**Payments shall be made under:**

<b>Item No.</b>	<b>Pay Item</b>	<b>Pay Unit</b>
2038140	Mon. Device - Vibrating Wire Rod Extensometers	EA

**(88) DIVISION 700: AXIAL O-CELL LOAD TESTING OF DRILLED SHAFTS**

**1. DESCRIPTION**

This work shall consist of furnishing all materials, equipment, labor, and incidentals necessary for conducting axial load testing of one drilled shaft. Axial load tests shall be performed as shown on the plans.

The axial testing shall be performed using two levels of Osterberg-Cells. The Contractor will be required to supply material and labor as necessary to prepare for and perform the load test and to restore the site once the load test is completed. The drilled shaft used for the load test program will be instrumented by LOADTEST, Inc. (the Osterberg Cell supplier). The Contractor shall subcontract with LOADTEST, Inc. to supply the Osterberg-Cells and other necessary equipment and instrumentation, perform the test, and analyze the results of one axial load test on one test shaft. Immediately prior to the placement of the reinforcement cage, the shaft dimensions and verticality shall be determined using a soniCaliper system, as provided and operated by LOADTEST, Inc.

The Osterberg cell equipment shall have sufficient capacity to fully mobilize the test shafts' ultimate capacity. The applied load shall at least be equivalent to the test shaft load specified in the plans.

**2. ORDER OF ACTIVITIES**

For the test shaft, proposed instrumentation location shall be provided to the Department a minimum of 7 days prior to the fabrication of the shaft reinforcement cage. The Department will provide comments for the final instrumentation locations within 3 days after receiving this information.

Strain and pressure gage instrumentation, displacement transducers, CSL access tubes, O-cells and any other materials and equipment required by LOADTEST, Inc. shall be installed on the reinforcing cage.

Immediately prior to placement of the reinforcement cage, the dimensions and verticality of the drilled shaft excavation shall be determined by LOADTEST, Inc. using the soniCaliper system.

CSL testing will be performed by the Department personnel or a Department designated representative in accordance with Section 727 of the Standard Specifications. CSL logging will be performed between a minimum of 3 days and a maximum of 7 days after concrete placement provided the concrete has attained a compressive strength of at least 3,000 psi during this period.

The axial Osterberg-Cell (O-cell) testing shall not begin until at least 4 days after CSL testing and until the concrete has attained a compressive strength of 4,000 psi. With approval of the Engineer and the Department, high early strength concrete may be used to obtain this strength at an earlier time to prevent testing delays.

The Contractor shall cooperate with the Department's personnel whom shall be granted access to all facilities necessary for observation of the test and the viewing of the test results.

**3. SUBMITTALS**

The Contractor shall submit to the Department for approval three (3) sets of shop drawings, erection plans, test calculations and details associated with the axial O-cell testing within 21 days following the Notice to Proceed. The submittal shall include details with respect to the reinforcement cage fabrication,

## EXHIBIT 5 - SPECIAL PROVISIONS

instrumentation plans, reference beams and movement measuring systems. All details, drawings, calculations, and procedures shall be submitted to the Department for review a minimum of 21 days prior to beginning the axial load test. Approval of this submittal by the Department shall not relieve the Contractor from making subsequent changes that may become necessary to carry out the test.

### 4. MATERIALS

The Contractor shall supply all materials required to install the Osterberg cell, conduct the load test, and remove the load test apparatus as required.

The Contractor shall furnish two (2) Osterberg Cell assemblies as required for the test shaft, to be supplied by:

**LOADTEST, Inc.** 2631-D NW 41st Street Gainesville, FL 32606  
Phone: **(800) 368-1138**, (352) 378-3717, Fax: (352) 378-3934

The Osterberg cell assemblies to be provided shall have a capacity that fully mobilizes the test shafts' ultimate capacity and shall be equipped with all necessary hydraulic lines, fittings, pressure source, pressure gage and telltale devices.

Additional materials required include, but are not limited to, the following:

- Fresh, clean, potable water from an approved source to be used as hydraulic fluid to pressurize the Osterberg Cell(s).
- Materials sufficient to construct and shade a stable reference beam system for monitoring movements of the shaft during testing. The system shall be supported at a minimum distance of 3 shaft diameters from the center of the test shaft to minimize disturbance of the reference system. A tripod shall be provided to support an automated digital survey level used to monitor movement of the reference system during testing. Alternatively, two survey levels located in excess of three shaft diameters may be used to monitor the top of shaft displacement in lieu of the beam. In this case, two tripods and weather protection (Quikshade) shall be provided.
- Materials sufficient to construct a protected work area (including provisions such as a tent or shed for protection from inclement weather for the load test equipment and personnel) of size and type required by the Engineer, Department, and LOADTEST, Inc. In the case of cold weather, the protected work area shall be maintained at a temperature above 40° F in order to insure proper operation of the load testing equipment.
- Stable electric power source, as required for lights, welding, instruments, etc.
- Materials such as angle or channel iron, steel bearing plates and/or other devices needed to attach O-cell assembly to rebar cage or carrying frame, as required.

Materials supplied which do not become a part of the finished structure become the property of the Contractor at the conclusion of the load test and shall be removed from the job site.

### 5. EQUIPMENT

The Contractor shall supply equipment required to install the Osterberg cells, conduct the load tests, and remove the load test apparatus as required. Equipment required includes but is not limited to:

- Welding equipment and certified welding personnel, as required, to assemble the test equipment under the supervision of LOADTEST, Inc. attach hydraulic fittings and telltales to the Osterberg cells, and prepare the work area.
- Equipment and labor to construct the reinforcing steel cage and/or placement frame required for the test shaft, including steel bearing plates as required.
- Equipment and operators for handling the Osterberg cells and instrumentation and placement

## EXHIBIT 5 - SPECIAL PROVISIONS

frame or reinforcing steel cage during the installation of the Osterberg cells and during the conduct of the test, including but not limited to a crane or other lifting device for Osterberg cells and instrumentation, manual labor, and hand tools as required by LOADTEST, Inc.

- Equipment and labor sufficient to erect the protected work area and monitoring reference beam system, to be constructed to the requirements of the Engineer, the Department, and LOADTEST, Inc.
- Air compressor (minimum 150 cfm) for pump operation during load testing.
- Strain Gauges – the Contractor shall supply the number of strain gauges as required at each level. The number of strain gauges will be determined by the Contractor after consultation with Loadtest, inc., and as approved by the Department. All cost for supplying strain gauges will be included in the price bid for Axial Load Test with Osterberg Load Cell, and no additional payment will be made for this equipment.

### 6. PROCEDURE

The Contractor shall perform the drilled shaft excavation in accordance with Section 712 of the Standard Specifications.

The Osterberg Cells, hydraulic supply lines and other instruments will be assembled and made ready for installation under the direction of LOADTEST, Inc. and the Department, in a suitable area, adjacent to the test shaft, to be provided by the Contractor. The Osterberg Cell assemblies shall be welded to the rebar cage or carrying frame. The plane of the bottom plate(s) of the O-cell(s) shall be set at right angles to the long axis of the cage. The Contractor shall use the utmost care in handling the test assembly so as not to damage the instrumentation during installation. The contractor shall limit the deflection of the cage to two (2) feet between pick points while lifting the cage from the horizontal position to vertical. The maximum spacing between pick points shall be 25 feet. The contractor shall provide support bracing, strong backs, etc. to maintain the deflection within the specified tolerance. The O-cell assemblies must remain perpendicular to the long axis of the reinforcing cage throughout the lifting and installation process.

When the test shaft excavation has been completed, inspected, callipered using the soniCaliper equipment and accepted by the Department, the O-cell assembly and the reinforcing steel may be installed. A seating layer of concrete shall be placed in the base of the shaft to provide a level base and reaction for the lower O-cell assembly. The seating layer shall be placed using a pump line or tremie pipe extending through the O-cell assemblies to the base of the shaft. After seating the Osterberg cell assembly, the remainder of the drilled shaft shall be concreted in a manner similar to that specified for production shafts. At least four (4) concrete test cylinders, in addition to those specified elsewhere, shall be made from the concrete used in the test shaft, to be tested at the direction of LOADTEST, Inc. At least one of these test cylinders shall be tested prior to the load test and at least two cylinders shall be tested on the day of the load test.

During the load test, no casings may be vibrated into place in the foundation area, within a 100 ft radius of the load test. Drilling may not continue within a 100-foot radius of the test shaft. If test apparatus shows any interference due to construction activities outside of this perimeter, such activities shall cease immediately.

After the completion of the load test, and at the direction of the Department, the Contractor shall remove any equipment, material, waste, etc. which are not to be a part of the finished structure.

### 7. LOAD TESTING AND REPORTING

The load testing shall be performed by a qualified geotechnical engineer approved in advance by the Department. The geotechnical engineer must have a demonstrated knowledge of load testing procedures, and have performed at least 10 Osterberg cell load tests within the past two years. The load testing shall be performed in general compliance with *ASTM D 1143 Standard Test Method for Piles Under Static Axial Load* using the Quick Load Test Method for Individual Piles. Initially the loads shall be applied in increments equaling 5 to 10% of the anticipated ultimate capacity of the test shaft. The magnitude of the load increments may be increased or decreased depending on the project requirements

but should not be changed during the test. Direct movement indicator measurements should be made of the following: O-cell expansion either directly or with telltales (minimum of 3 indicators required), upward top-of-shaft displacement (minimum of 2 indicators required) and shaft compression above O-cell (minimum of 2 indicators required). Loads shall be applied in three stages by: 1) pressurizing the lower O-cell while the upper assembly remains closed, 2) pressurizing the upper O-cell while the lower O-cell is allowed to freely drain and 3) pressurizing the upper O-Cell while the hydraulics are closed on the lower O-cell. Loads shall be applied at the prescribed intervals until the ultimate capacity of the shaft is reached in either end bearing or side shear, until the maximum capacity or maximum stroke of an O-cell is reached, or unless otherwise directed by the Department. At each load increment, or decrement movement indicators shall be read at 1, 2, 4 and 8-minute intervals while the load is held constant. During unloading cycles the load decrement shall be such that at least 4 data points are acquired for the load versus movement curve. Additional cycles of loading and unloading using similar procedures may be required by the Department following the completion of the initial test cycle. Displacement sensors used to measure O-cell expansion and top-of-shaft displacement should have a minimum travel of 4 inches and be capable of being read to the nearest 0.001 inch division. When O-cell expansion is measured directly, LVWDTs capable of measuring the full stroke of the Osterberg Cell will be used (typically 6 inches). Displacement sensors used to measure shaft compression should have a minimum travel of 1 inch and be capable of being read to the nearest 0.001 inch division.

Unless otherwise specified by the Department, the Contractor will supply four (4) paper copies of a report of each load test, as prepared by LOADTEST, Inc. and a PDF electronic copy. An initial data report containing the load-movement curves and data tables will be provided to the Department within 3 working days of the completion of load testing, to allow evaluation of the test results. A final report on the load testing shall be submitted to the Department within 7 working days after completion of the load testing.

**8. METHOD OF PAYMENT**

The Axial Drilled Shaft Load Tests shall be considered as any material, labor, equipment, load cells, etc. required above the requirements of production drilled shaft installation necessary to install, conduct, and remove the drilled shaft load test at the direction of the Department and LOADTEST Inc. representative. All costs of the axial load test including subcontracting to LOADTEST Inc. will also be included in the price bid for this work.

All costs associated with the normal production of the drilled shaft are measured and paid for elsewhere in the contract documents.

**9. DISPOSITION OF TEST SHAFT**

After completion of all testing and the submittal of the required reports, the test shaft shall be cut-off at a depth of 1 ft below the ground surface. The cut-off portion of the shaft shall be properly disposed of by the contractor and the resulting hole shall be backfilled with soil in accordance with Section 205 of the Standard Specifications. The test area shall be graded smooth.

**10. BASIS OF PAYMENT**

The complete and accepted "Drilled Shaft Osterberg Cell Load Tests" shall be paid for at the contract lump sum price for each. This shall constitute full compensation for all costs incurred during the procurement, installation, conducting of the test, and subsequent removal of test apparatus and appurtenances.

**11. PAYMENT**

Payments shall be made under SCDOT Pay Item No. 8990181, Axial Load Test with Osterberg Cell Load".

**(89) DIVISION 700: APPLE LOAD TESTING**

April 18, 2013

**1.0 GENERAL**

This work shall consist of performing high-strain dynamic testing using the APPLE dynamic loading system on a test shaft for the purpose of determining and/or verifying the ultimate bearing capacity of the production shafts. Production shaft lengths may be adjusted after results of the test shaft have been analyzed. No materials shall be ordered until shaft lengths are approved by the Department. The test shaft depth, diameter, and location shall be as specified in the plans. The testing specified in the project documents shall be conducted in general accordance with ASTM D4945 and this Special Provision.

The APPLE Load Testing equipment shall have sufficient capacity to fully mobilize the test shafts' ultimate capacity. The applied load shall at least be equivalent to the test shaft load specified in the plans.

The location of the test shaft (non-production) shall be as indicated in the plans. The test shaft shall maintain a minimum distance of 25 feet from any foundation element of any future bent. The Contractor shall submit the proposed location to the Department for approval.

Load testing of the test shaft shall not begin until the concrete has attained a compressive strength of no less than 4,000 psi and had a curing time of no less than 7 days. High early strength concrete may be used to obtain the required strength at an earlier time to prevent testing delays, upon the approval of the Department.

The Contractor will be required to furnish and include all costs in the bid item for all materials, personnel, and equipment as described in the plans and Special Provisions and as required by the Contractor to adequately perform the APPLE Load Test. The Contractor shall engage the services of an approved APPLE supplier for instrumenting, performing, and reporting of the load test. The Contractor must provide a minimum of 45 days notice to the APPLE supplier before the load testing. An approved APPLE supplier may be contacted at:

GRL Engineers, Inc., 9912 Colvard Circle, Charlotte, NC 28269  
Phone: (704) 593-0992, Fax: (704) 593-0993

The Contractor shall submit to the Department for approval 3 sets of shop drawings, erection plans, and test calculations and details. The Contractor should include details with respect to the movement measuring system and the method for measuring the applied load. The Contractor shall also submit details and shop drawings of the proposed set up for review by the Department 2 weeks prior to beginning construction of the testing arrangements (including the test shaft). All details, drawing calculations, and procedures shall be submitted to the Department for review a minimum of 2 weeks prior to beginning the APPLE Load Test. Approval of these submittals by the Department shall not relieve the Contractor from making subsequent changes that may become necessary to carry out the test.

The Contractor, in cooperation with the APPLE supplier will supply and supervise the mobilization, assembly, and operation of the APPLE Load Test equipment. APPLE supplier will provide and install the required instrumentation for the test shaft, acquire the test data during testing, and culminate the APPLE data into a report. The report will be presented to the Contractor and the Department for evaluation. Interpretation of the test data with regard to foundation recommendations will be performed by the Department.

## 2.0 MATERIALS & EQUIPMENT

The APPLE supplier will supply all materials, personnel and equipment as described below and as required by the Contractor and the APPLE supplier to adequately perform the APPLE Load Test. Such materials and equipment are:

1. APPLE dynamic loading system and all items specifically incidental to the APPLE test system.
2. Means to insure flat, level (axial to test shaft), and solid concrete shaft top.
3. A drop weight of no less than 20 tons. The impacting surface of the drop weight should have an area between 70 and 130 percent of the test shaft top area. The cross-sectional shape of the drop weight shall be as regular as possible (square, round, hexagonal, etc.).
4. A guiding frame allowing variable drop heights typically between 3 and 7 feet, or as determined by the APPLE Testing Engineer (described herein **at as** Testing Engineer) in consultation with the Department.
5. A top cushion consisting of new sheets of plywood with a total thickness of 2 to 6 inches, or as determined by the Testing Engineer in consultation with the Department.
6. A surveyor's transit, laser light or equivalent for measurements of test shaft set under each drop weight impact.
7. Dynamic testing shall be performed and/or supervised by a Licensed Professional Engineer in South Carolina with at least two years of dynamic testing experience.
8. Final Report of APPLE Load Testing no later than 14 days after all APPLE Load Testing is completed and accepted by the Department. Field results of the APPLE Load Test will be provided within 72 hours of test completion.

The Contractor shall supply any additional equipment and personnel to assemble, perform, disassemble, and move to next test site (if applicable). This equipment includes, but not be limited to, the following:

1. Unloading and loading of the APPLE trucks during mobilization and demobilization.
2. Any necessary on-site mobilization of test equipment.
3. A level and firm surface surrounding the test shaft to support the APPLE testing system.
4. A level and smooth shaft top. The top of the test shaft shall incorporate permanent casing length as indicated in the plans and have a minimum ½-inch wall thickness. There shall be at least 6 inches between the top of the test shaft and the top of the casing left in place.
5. A crane, rigging and operator capable of lifting, unloading, assembling, disassembling, and packing all APPLE equipment. The crane and rigging should be of sufficient size and strength to handle the required APPLE equipment.
6. Power source adequate for electronic equipment.
7. For over water tests only, welding equipment and welder for falsework platform.

## 3.0 PREPARATION FOR TESTING

Notification of the requirement for an APPLE Load Test shall be provided by the Contractor to the Department at least 45 days in advance of the test. The Contractor shall perform site and foundation preparation. Foundation preparation includes the cutting and cleaning of the surface of the test shaft down to test elevation. The top of the test shaft shall be smooth and level. The area

around the test shaft, on land, should be leveled and compacted within a 15 foot radius. The top of shaft should be approximately 6 feet above grade for axial testing. For over water or elevated work areas, the area provided must be level and at the test elevation. The support falsework platform shall be assembled and installed by the Contractor at the test location.

Prior to performing the load test, the Testing Engineer must be provided with soil boring logs, test shaft installation records, concrete properties (strength, etc.) and details regarding the anticipated dynamic loading equipment. The Testing Engineer is required to perform wave equation analyses (using GRLWEAP or equivalent) to determine the suitability of the proposed dynamic load testing equipment and an acceptable range of drop weight heights so as not to cause damage in the test shaft during the test.

#### **4.0 PROCEDURE FOR APPLE LOAD TESTING**

The Contractor shall assist the Testing Engineer as necessary during all aspects of the APPLE Load Test. The following steps shall be taken in the performance of the APPLE Load Test.

1. Preparation for testing as described in Section 3.0.
2. Prior to testing, the Contractor shall make the upper 6 feet of the test shaft completely accessible to the Testing Engineer.
3. Four "windows" (approximate size of 6 by 6 inches) diametrically opposite of each other shall be located and removed from the casing, if appropriate, or an entire band of the casing removed to expose a smooth concrete surface for attachment of the sensors. Sensors are typically attached at least one diameter below the shaft top. Sensor locations will be determined by the Testing Engineer.
4. In areas where casing is not present, the Testing Engineer, or Contractor under the direction of the Testing Engineer, shall smooth (by grinding) areas around the test shaft circumference such that proper sensor attachment can be accomplished.
5. Sensors shall be attached by the Testing Engineer or under the direction of the Testing Engineer to the exposed concrete in a secure manner as to prevent slippage under impact.
6. Shaft top should be examined to insure having a smooth level surface.
7. Survey and record the shaft top elevation to a bench mark.
8. Apply plywood cushion and striker plate to the shaft top.
9. Two to four hammer impacts with varying drop heights should be applied to the top of the shaft. The first drop height should be minimal to allow the Testing Engineer to assess the testing equipment, the driving system and stresses on the shaft. Subsequent impacts can then be applied by utilizing sequentially higher drop heights until either stresses in the shaft are excessive or the shaft permanent set for the applied impact exceeds 0.1 inch.

#### **5.0 INSTRUMENTATION**

The intent of the load test instrumentation is to measure the test load and its distribution between side friction and end bearing, load versus deflection, to provide information for design calculations and estimates, and to provide information for final design. The Contractor shall provide assistance when requested by the Testing Engineer during installation of any instrumentation supplied through this contract.

## EXHIBIT 5 - SPECIAL PROVISIONS

The cost of all instrumentation, to be installed as directed by the APPLE supplier, shall be included in the cost for APPLE Load Testing. Instrumentation pertaining to the APPLE testing, and listed below, shall be provided by the APPLE supplier in addition to any instrumentation outlined in ASTM D 4945.

1. Pile Driving Analyzer<sup>®</sup> (PDA) manufactured by Pile Dynamics, Inc., model PAK, PAX or PAL or equivalent.
2. Four calibrated strain transducers.
3. Four calibrated accelerometers.

### 6.0 REPORTING OF RESULTS

It is the APPLE supplier's responsibility to submit a Final Report of APPLE Load Testing no later than 14 days after all APPLE load testing is completed and accepted by the Department. Field results of the APPLE Load Test shall be provided within 72 hours of test completion. In addition to the field results, results from a CAPWAP<sup>®</sup> analysis or equivalent shall be submitted. A CAPWAP<sup>®</sup> analysis shall be completed for each hammer impact in the field and shall be performed by an Engineer that has achieved Advanced Level or better on the Foundation QC High Strain Dynamic Pile Testing Examination. The report must also provide the following:

1. Wave Equation analysis results obtained prior to testing.
2. CAPWAP<sup>®</sup> (or equivalent) analysis results.
3. The maximum measured force, maximum calculated tension force, transferred energy to the sensor location, corresponding stresses, and the Case Method bearing capacity for each impact.
4. Assessment of the test results both with respect to pile capacity and integrity.

### 7.0 METHOD OF MEASUREMENT

The quantity of the pay item "Drilled Shaft Axial Load Test is measured by each (EA) APPLE Load Test completed and accepted by the Department. A completed APPLE Load Test shall be one test conducted on a shaft using the APPLE dynamic loading system and meeting +/-15% of, or exceeding the target APPLE test peak load as specified in the plans and Special Provisions.

The APPLE Load Test shall be considered as any material, labor, equipment, instrumentation, etc. required above. This item should include everything necessary to assemble, install, perform, collect data, and remove the APPLE Load Test equipment; under the direction of the APPLE supplier and others.

### 8.0 DISPOSITION OF TEST SHAFT

After all testing and data collection has been completed, the test shaft shall be cut off to a minimum depth of 5 feet below the ground surface. It shall be the Contractor's responsibility to dispose of the cut off section of the test shaft.

### 9.0 BASIS OF PAYMENT

APPLE Load Testing will be paid for at the contract bid price per each accepted test. The price and payment shall be considered full compensation for furnishing all materials, providing all tools, equipment, labor and incidentals, providing assistance to the production of the test shaft, performing the APPLE Load Test, and disposing of the test shaft as described in Section 8.0



## EXHIBIT 5 - SPECIAL PROVISIONS

above.

### 10.0 PAYMENT

Payment shall be made under SCDOT Pay Item No. 7120166, "Drilled Shaft Axial Load Test".

### (90) DIVISION 700: STATNAMIC LOAD TESTING

#### 1.0 GENERAL

This work shall consist of performing a Statnamic axial compression load test on a test shaft for the purpose of determining and/or verifying the ultimate bearing capacity of the production shafts. Production shaft lengths may be adjusted after results of the test shaft have been analyzed. No materials shall be ordered until shaft lengths are approved by the Department. The test shaft depth, diameter, and location shall be as specified in the plans. The testing specified in the project documents shall be conducted in general accordance with ASTM D7383-08 and this Special Provision.

The Statnamic Load Testing equipment shall have sufficient capacity to fully mobilize the test shafts' ultimate capacity. The Statnamic load shall at least be equivalent to the test shaft load specified in the plans.

The location of the test shaft (non-production) shall be as indicated in the plans. The test shaft shall maintain a minimum distance of 25 feet from any foundation element of any future bent. The Contractor shall submit the proposed location to the Department for approval.

Load testing of the test shaft shall not begin until the concrete has attained a compressive strength of no less than 4,000 psi and had a curing time of no less than 7 days. High early strength concrete may be used to obtain the required strength at an earlier time to prevent testing delays, upon the approval of the Department.

The Contractor will be required to furnish and include all costs in the bid item for all materials, personnel, and equipment as described in the plans and Special Provisions and as required by the Contractor to adequately perform the Statnamic load test. The Contractor shall engage the services of an approved Statnamic supplier for instrumenting, performing, and reporting of the load test. The Contractor must provide a minimum of 45 days notice to the Statnamic supplier before the Statnamic testing. If strain instrumentation is utilized, a minimum of 45 days notice shall be given to the Statnamic supplier before the test shaft construction to allow for instrumentation installation. An approved Statnamic supplier may be contacted at:

Applied Foundation Testing, Inc. 4035 J. Louis Street, Green Cove Springs, FL 32043  
Phone: (904) 284-1337, Fax: (904) 284-1339

The Contractor shall submit to the Department for approval 3 sets of shop drawings, erection plans, and test calculations and details. The Contractor should include details with respect to the movement measuring system, the piston support system, and the method for measuring the applied load. The Contractor shall also submit details and shop drawings of the proposed set up for review by the Department 2 weeks prior to beginning construction of the testing arrangements (including the test shaft). All details, drawing calculations, and procedures shall be submitted to the Department for review a minimum of 2 weeks prior to beginning the Statnamic load test. Approval of these submittals by the Department shall not relieve the Contractor from making subsequent changes that may become necessary to carry out the test.

The Contractor, in cooperation with the Statnamic supplier will supply and supervise the mobilization, assembly, and operation of the Statnamic load test equipment. Statnamic supplier

## EXHIBIT 5 - SPECIAL PROVISIONS

will provide and install the required instrumentation for the test shaft, acquire the test data during testing, and culminate the Statnamic data into a report. The report will be presented to the Contractor and the Department for evaluation. Interpretation of the test data with regard to foundation recommendations will be performed by the Department. Statnamic testing is non-destructive and entails no greater danger of shaft damage than static load testing.

### 2.0 MATERIALS

The Statnamic supplier will supply all materials, personnel and equipment as described below and as required by the Contractor and the Statnamic supplier to adequately perform the Statnamic load test. Such materials and equipment are:

1. Statnamic apparatus, including pressure chamber and cylinder, reaction masses, exhaust silencer, gravel structure, gravel structure base frame, and all items specifically incidental to the Statnamic test system.
2. Foundation top plate (and follower assembly, if needed), adequate to distribute the applied Statnamic test load to the test shaft.
3. Statnamic load, acceleration transducers, and data acquisition system pertaining directly to the Statnamic device. All required electronic equipment for the recording, processing, and storage of the Statnamic test will be operated by the Statnamic supplier.
4. Resistance based strain gages and sufficient cabling (if required).
5. One Geotechnical Engineer and one technician experienced in the implementation of the Statnamic test methods who will direct the test setup, perform the testing, direct the disassembly of the test apparatus, provide load test submittals, provide assistance as needed with pertinent Statnamic issues, and provide a written report.
6. Final Report of Statnamic Load Testing no later than 14 days after all Statnamic load testing is completed and accepted by the Department. Field results of the Statnamic load test will be provided within 72 hours of test completion.

Additional materials required for the Statnamic load test shall be supplied by the Contractor as specified by the Statnamic supplier and include, but are not limited to, the following:

1. Support piles for falsework platform. A falsework platform is not required for land based testing. However, materials such as crane mats and plywood may be necessary to provide a level and firm surface to assemble the Statnamic device on land based testing.
2. ¾ inch (19 mm) clear gravel with less than 5 percent fines, 105 cubic yards (81 cubic meters) per test. The gravel material must be approved by the Department. (Note that #67 Stone has been used successfully in the past.)
3. Statnamic load, acceleration transducers, and data acquisition system pertaining directly to the Statnamic device. All required electronic equipment for the recording, processing, and storage of the Statnamic test will be operated by the Statnamic supplier.

### 3.0 EQUIPMENT

The Contractor shall supply any additional equipment and personnel to assemble, perform, disassemble, and move to next test site (if applicable). This equipment includes, but not be limited to, the following:

1. Unloading and loading of the Statnamic trucks during mobilization and demobilization.
2. Any necessary on-site mobilization of test equipment.

## EXHIBIT 5 - SPECIAL PROVISIONS

3. A level and firm surface surrounding the test shaft to support the Statnamic device.
4. A level and smooth shaft top. The top of the test shaft shall incorporate permanent casing length as indicated in the plans and have a minimum ½-inch wall thickness. There shall be at least 6 inches between the top of the test shaft and the top of casing left in place.
5. A crane, rigging and operator capable of lifting, unloading, assembling, disassembling, and packing all Statnamic equipment. The crane and rigging should be of sufficient size and strength to handle the required Statnamic equipment.
6. Power source adequate for electronic equipment.
7. For over water tests only, welding equipment and welder for falsework platform.

### 4.0 PREPARATION FOR TESTING

Notification of the requirement for a Statnamic load test shall be provided by the Contractor to the Department at least 45 days in advance of the test. The Contractor shall perform site and foundation preparation. Foundation preparation includes the cutting and cleaning of the surface of the test shaft down to design or test elevation. The top of the test shaft shall be smooth and level. The area around the test shaft, on land, should be leveled and compacted within a 15 foot radius. The top of shaft should be approximately 2 feet above grade for axial testing. For over water or elevated work areas, the area provided must be level and at the test elevation. The support falsework platform shall be assembled and installed by the Contractor at the test location.

### 5.0 PROCEDURE FOR AXIAL STATNAMIC LOAD TESTING

The Contractor shall assist the Statnamic supplier as necessary during all aspects of the Statnamic Load Test. The following steps shall be taken in the performance of the Statnamic Load Test.

1. Preparation for testing as described in Section 4.0.
2. Place the piston mounting plate on the center of the test shaft, level the plate and secure with anchor bolts or welding.
3. Survey and record the shaft top elevation to a bench mark.
4. Bolt the piston assembly to the piston mounting plate.
5. Set the base frame for the gravel containment structure.
6. Connect load cell cable, ignition cable, and accelerometers to piston.
7. Connect all instrumentation to the data acquisition system.
8. Install the predetermined propellant fuel charge. Check the ignition initiating circuit for the correct resistance.
9. Install vent pin with new seal. Grease piston and cylinder. Place cylinder over piston.
10. Place reaction masses. Secure the masses to the cylinder assembly.
11. Place the gravel containment structure and secure into position.
12. Fill the annular space between the gravel containment structure and the Statnamic apparatus using gravel.

## EXHIBIT 5 - SPECIAL PROVISIONS

13. Check the assembled device to ensure there is no physical interference of the load or acceleration monitoring systems.
14. Clear the test work area of personnel.
15. Perform final check of instrumentation and recording equipment.
16. Perform the test.
17. Back up test data on hard drive or jump drive.

### 6.0 INSTRUMENTATION

The intent of the load test instrumentation is to measure the test load and its distribution between side friction and end bearing, load versus deflection, to provide information for design calculations and estimates, and to provide information for final design. The Contractor shall provide assistance when requested by Statnamic supplier during installation of any instrumentation supplied through this contract. The Contractor should be aware that lead times are required for ordering instrumentation. The Contractor shall take the lead times into account when planning the work. The instrumentation shall be installed prior to the construction or installation of the test shaft. A minimum of 45 days notice shall be given by the Contractor to the Statnamic supplier prior to test shaft construction to schedule the installation of the instrumentation.

The cost of all instrumentation, to be installed as directed by the Statnamic supplier, shall be included in the cost for Statnamic Load Testing. Instrumentation pertaining to the Statnamic testing, and listed below, shall be provided by the Statnamic supplier.

1. Electronic Resistance Based Strain Gages – A total of 20 resistance based strain gages shall be provided, 5 vertical levels with 4 gages per level. Lead wire should be unspliced.
2. Accelerometers – A total of 3 accelerometers shall be arranged across the top of the test shaft approximately 120 degrees apart during Statnamic testing.
3. Data Acquisition System – The resistance strain gages will require specialized equipment capable of digitizing at very fast rates. The Statnamic supplier shall supply the necessary equipment and record the test data.

### 7.0 METHOD OF PAYMENT

The quantity of the pay item “Drilled Shaft Axial Load Test” is measured by each (EA) Statnamic load test completed and accepted by the Department. A completed Statnamic load test shall be one test conducted on a shaft using the Statnamic method and meeting +/-15% of, or exceeding the target Statnamic test peak load as specified in the plans and Special Provisions.

The Statnamic load test shall be considered as any material, labor, equipment, instrumentation, etc. required above and including the requirements of test shaft installation. This item should include everything necessary to assemble, install, perform, collect data, and remove the Statnamic load test equipment; under the direction of the Statnamic supplier and others.

### 8.0 DISPOSITION OF TEST SHAFT

After all testing and data collection has been completed, the test shaft shall be cut off to a minimum depth of 5 feet below the ground surface. It shall be the Contractor's responsibility to dispose of the cut off section of the test shaft.

EXHIBIT 5 - SPECIAL PROVISIONS

9.0 BASIS OF PAYMENT

Statnamic load testing will be paid for at the contract bid price per each accepted test. The price and payment shall be considered full compensation for furnishing all materials, providing all tools, equipment, labor and incidentals, providing assistance to the production of the test shaft, performing the Statnamic load test, and disposing of the test shaft as described in Section 8.0 above.

10.0 PAYMENT

Payment shall be made under SCDOT Pay Item No. 7120166, "Drilled Shaft Axial Load Test".

**(91) PAVING UNDER GUARDRAIL**

August 17, 2011

Section 403 is expanded as follows:

**GENERAL:**

Provide paving under guardrail as shown in the plans, in accordance with plan details and these special provisions. Pavement under guardrail shall only be placed where shown in the plans or as directed by the Engineer.

**MATERIALS:**

Pavement material under guardrail shall be the same as the hot mix asphaltic concrete surfacing being used on the adjacent roadway. Liquid asphalt binder shall be the same as that used for paving on the adjacent roadway.

Low density Flowable Fill with a maximum 28 day compressive strength of 120PSI shall be used to fill leave-out areas.

**CONSTRUCTION:**

Place hot mix asphaltic concrete surfacing under guardrail in accordance with Section 401 of the Standard Specifications where indicated on the plans or as directed by the Engineer. Refer to details provided in this special provision for typical limits of paving and requirements for leave-out areas around guardrail posts.

Pave area between the edge of pavement and the face of the guardrail when that distance is less than 20 feet.

Extend paving under guardrail to bridge end at locations where concrete approach slabs are used.

When at least one opening between parallel lines of guardrail is less than 20 feet wide, pave the entire area between the lines of guardrail.

When openings between parallel lines of guardrail are more than 20 feet wide, but obstructions such as bridge columns reduce the access between the guardrail and the obstruction to less than 20 feet and/or the distance between any two obstructions is less than 20 feet then the area with any single point of access less than 20 feet wide shall be paved.

When areas around obstructions are paved, no area should remain unpaved that will sustain plant life.

**EXHIBIT 5 - SPECIAL PROVISIONS**

The top of pavement shall be constructed to be flush with surrounding earth shoulders and slopes.

Damage to pavement during subsequent construction, especially during driving of guardrail posts, should be minimized. Any damaged pavement must be restored to its original line and grade to the satisfaction of the Engineer.

Leave outs shown in the details shall be either formed or sawcut.

**MEASUREMENT AND PAYMENT:**

Hot mix asphalt surface course shall be measured and paid for in accordance with Section 401 of the Standard Specifications.

Liquid asphalt binder shall be measured and paid for in accordance with Section 401 of the Standard Specifications.

When additional excavation is required to obtain the depth of pavement specified, this additional excavation will be measured separately and paid for by the cubic yard as unclassified excavation in accordance with section 203 of the Standard Specifications.

When borrow is needed to construct the area to be paved to meet the typical section, this borrow excavation will be measured and paid for separately as borrow excavation in accordance with section 203 of the Standard Specifications.

The costs to provide the leave outs shall be considered incidental to the hot mix asphalt surface course and no separate measurement or payment shall be made for providing leave out areas.

Flowable fill for leave out areas will be measured and paid for in accordance with section 210 of the Standard Specifications.

Payment under this section will include the following:

Item No.	Pay Item	Unit
2031000	UNCLASSIFIED EXCAVATION	CY
2033000	BORROW EXCAVATION	CY
2103000	FLOWABLE FILL	CY
40110XX	LIQUID ASPHALT BINDER PG __-22	TON
40303XX	HOT MIX ASPHALT CONCRETE SURFACE COURSE TYPE _	TON

EXHIBIT 5 - SPECIAL PROVISIONS

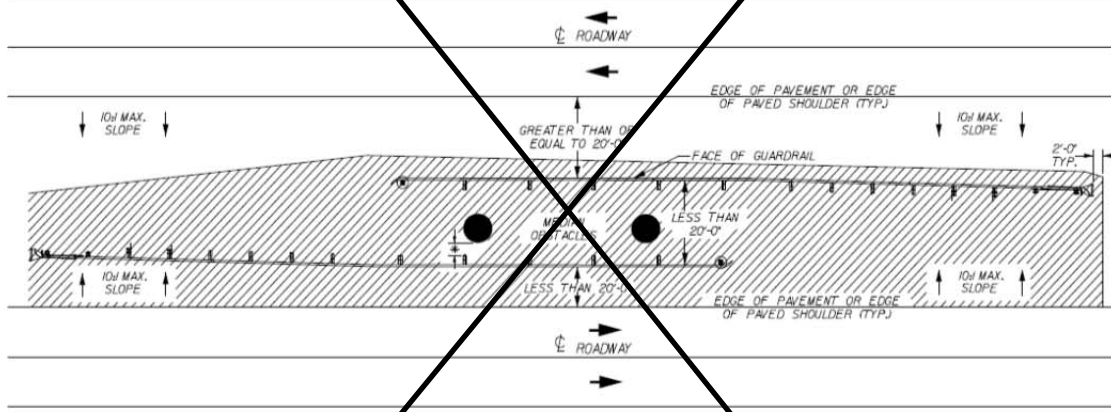
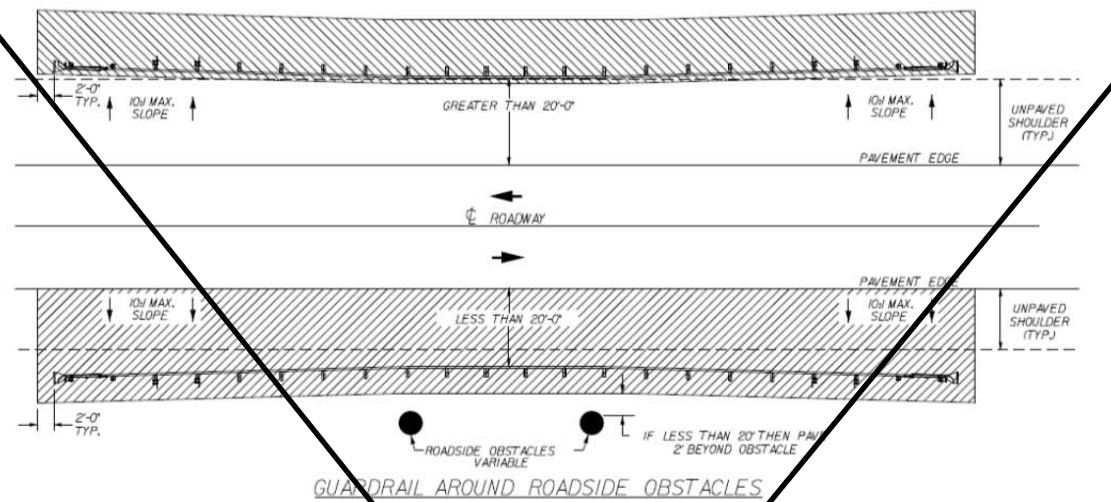

\* WHEN BACK OF POSTS TO FACE OF OBSTACLE IS GREATER THAN 36'-0" W-BEAM MAY BE USED, IS 36' TO 24' USE THREE BEAM GUARDRAIL, IS LESS THAN 24' USE CRITICAL OFFSET GUARDRAIL SHOWN ON DRAWING 805-015-00.

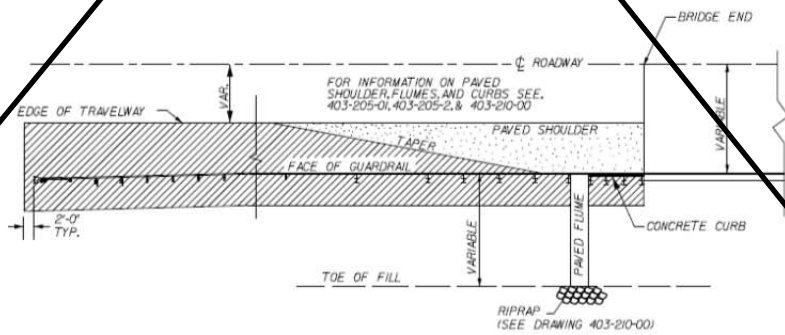

HOT MIX ASPHALT SURFACE COURSE UNDER GUARDRAIL

EXHIBIT 5 - SPECIAL PROVISIONS

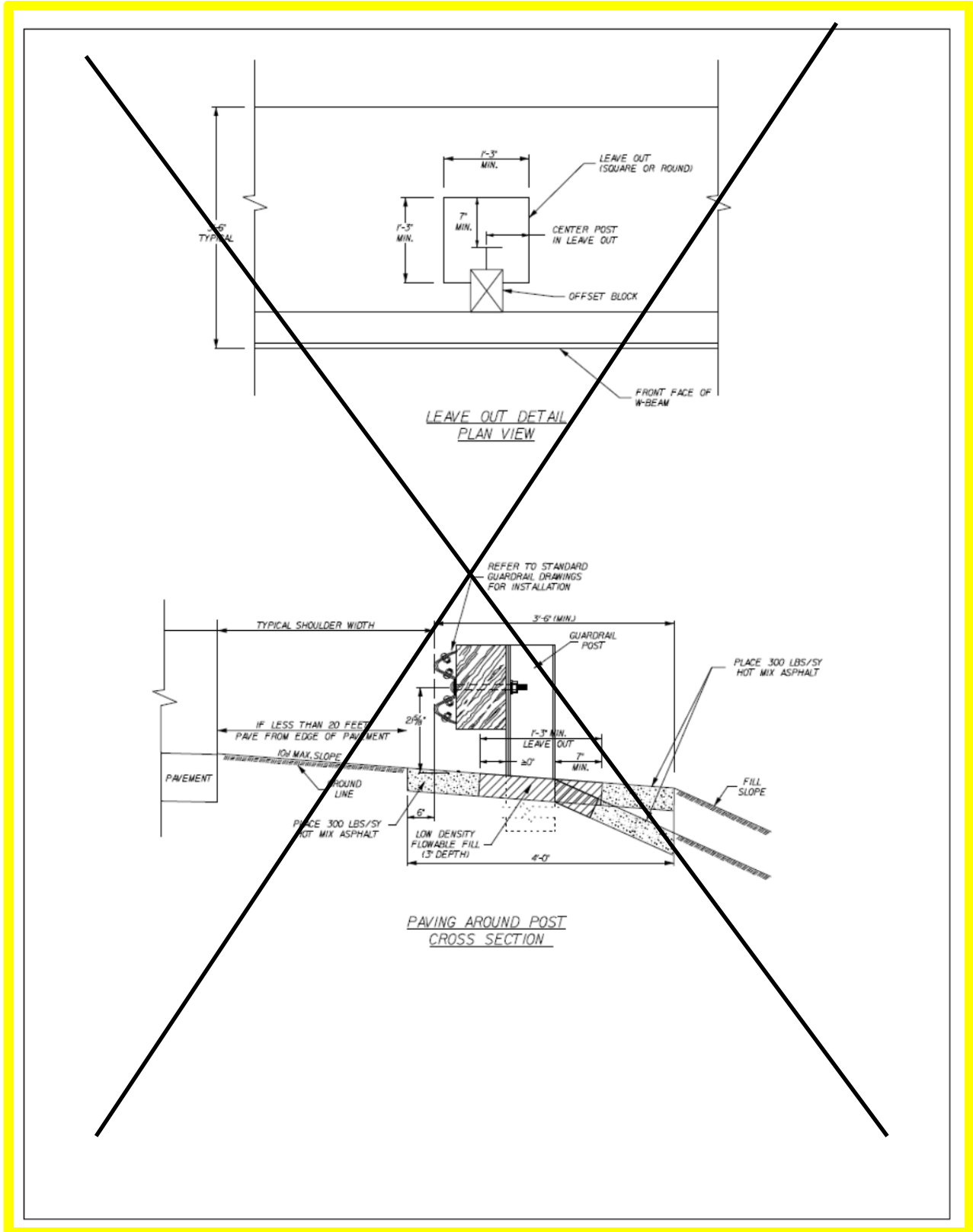



**(92) DIVISION 600: ADHESIVELY BONDED ANCHORS AND DOWELS**

See Supplemental Specifications and Forms, **EXHIBIT 6.**

**(93) DIVISION 702: CONCRETE STRUCTURES – PREFORMED JOINT FILLER**

Delete Subsection 702.2.2.1 of the Standard Specifications in its entirety and replace it with the following:

**702.2.2.1 Preformed Joint Filler**

Use preformed joint material that meets AASHTO M 153 or AASHTO M 213 with the following exceptions:

1. Use only materials manufactured from rubber.
2. Use materials that require a load of not less than 340 kPa or greater than 5200 kPa to compress to 50% of its thickness when tested in accordance with AASHTO T 42.
3. Use materials that have a recovery of at least 70% when tested in accordance with AASHTO T 42.

Use preformed joint material that is listed on QPL 81.

Provide a manufacturer’s certification that states that the material conforms to SCDOT specifications.

**(94) DIVISION 200: VIBRO COMPACTION**

This section presents administrative and procedural requirements for ground modification by Vibro-Compaction (VC). Vibro-compaction shall be implemented in and below the existing embankment fill material of both the beginning of bridge approach embankment and the end of bridge approach embankment. VC shall be provided as documented in the plans. The purpose of the vibro-compaction program is to densify the granular soils at the specified locations and depths to mitigate liquefaction potential.

The Contractor shall perform layouts and measurements for VC work. VC points may be surveyed in or located by measuring offsets from surveyed points (e.g., project stations) using a tape measure.

The Contractor shall notify the Engineer **and the Department** a minimum of 48 hours prior to commencement of the VC operations at each approach embankment location.

Any change in the predetermined VC program necessitated by a change in the field conditions shall be immediately reported and submitted to the Geotechnical Engineer **and the Department**. Upon completion of the work, the Contractor shall submit a drawing of as-built locations of vibro-compacted columns.

**REFERENCES**

The Geotechnical Engineer **and the Department** will coordinate all testing to determine compliance with the project design.

- A. Applicable Standards: The most recent version of the following testing methods or standards shall be employed:
  1. ASTM D1586 “Standard Test Method for Standard Penetration Test (SPT) and Split-Barrel Sampling of Soils”

## EXHIBIT 5 - SPECIAL PROVISIONS

2. ASTM D5778 "Standard Test Method for Electronic Friction Cone and Piezocone Penetration Testing of Soils" (CPT)
  3. ASTM D6635 "Standard Test Method for Performing the Flat Plate Dilatometer" (DMT)
- B. Reference Documents: Reference documents to be used by the Contractor shall include:
1. This specification.
  2. Attached plans.
  3. Project geotechnical report prepared by the Geotechnical Engineer.

Prior to commencing work, the Contractor shall examine the site, drawings, records of existing utilities and other existing subsurface structures, and soil test boring logs made available in the original bid documents and those performed by the Geotechnical Engineer to help determine VC installation conditions.

### **SUBMITTALS**

This section details all submittals required prior to field work, at completion of the test section, during production work, and after the work is completed.

- A. Pre-Field Work Submittals: The following shall be submitted to the SCDOT by the Geotechnical Engineer prior to the start of the work. VC operations may not commence until approval by the SCDOT is granted.
1. A Work Plan prepared by the Contractor for the production work outlining the anticipated spacing, location and depth to achieve the project design criteria.
  2. Drawing(s) for review, indicating the spacing, location, and depth of the VC probes to achieve the project design criteria.
- B. Post Test Section and Pre Production Work:
1. Results of the test section evaluation.
  2. A revised work plan and VC layout should the test section results require a modification to the original work and production plans.
- C. During Production Submittals: The following shall be submitted to the SCDOT by the Geotechnical Engineer during the work:
1. Any change in the predetermined VC program necessitated by a change in the field conditions.
- D. Closeout Submittal: The following shall be submitted to the SCDOT by the Geotechnical Engineer within 14 days of the completion of the VC work.
1. As built drawings: Drawings documenting any significant changes to the shop drawing. If no changes are noted, then no as-built drawings are necessary following completion of the VC program.

**EQUIPMENT AND MATERIALS**

The Contractor shall supply equipment in good operating condition capable of performing the work specified herein. The Contractor shall use equipment capable of efficiently accomplishing the required soil densification. The probe shall have durable markings on one foot intervals allowing a visual determination of the depth of penetration when in use. The probe shall be of sufficient length to extend a minimum depth of thirty (30) feet below existing grade.

The VC procedure is not intended to be a 'wet' operation. Water shall be used sparingly to mitigate clogging of the VC equipment.

Settlement resulting from the VC operations is anticipated. Any required fill placement in the resulting deformations required to meet the design grade(s) shall meet the requirements outlined in the *Special Provision 40 – Section 203: Borrow Excavation* provided in the bid documents.

Groundwater is anticipated to emerge to the ground surface during VC operations. The Contractor shall implement Best Management Practices (BMP's) to efficiently control surface groundwater runoff in accordance with the contract documents.

**CONSTRUCTION**

Production VC criteria shall be as follows:

1. Depth of treatment: The probe tip shall penetrate to the minimum elevation specified in the above referenced documents and submittals.
2. Locations/Spacing: The center to center probe spacing shall adhere to the requirements in the above referenced documents and submittals. Probes shall be performed within 12 inches of the planned location
3. Limits of work: The limits of the VC work are shown on the drawings described in the above referenced documents and submittals.

**QUALITY CONTROL**

The details of the quality control program are as follows:

- A. Technical Oversight: All VC operations shall be performed under the inspection of the Geotechnical Engineer's representative.
- B. Monitoring and Logging: Monitoring and logging of all VC operations for the test area and production work shall be done by the Contractor.
- C. Test Section: The Geotechnical Engineer's representative shall monitor the performance of the test section and perform the testing indicated below:
  1. A test section shall be performed before production work, as follows:
    - a. The test section location shall be agreed upon by the Geotechnical Engineer, the Department, and the Contractor within the treatment area. The test section will consist of a minimum of twelve (12) VC points in three (3) rows of four (4) points each. For preliminary design considerations, the vibro-densification program will utilize a five (5) foot triangular grid for the indicated treatment area(s).
    - b. The method of installation, materials, equipment, and procedures shall be the same as those to be used for production work.

## EXHIBIT 5 - SPECIAL PROVISIONS

- c. Based on the results from the test section, modifications to the Work Plan may be implemented, as needed, to meet the project design. Any changes to the Work Plan will be submitted to the SCDOT following completion of the test program.
  2. The Geotechnical Engineer shall coordinate the following tests of the test section after a minimum wait period of four (4) days from completion of the VC activities of the test program: One (1) CPT (*or SPT*) test performed at the center of a VC probe location, and one (1) CPT (*or SPT*) test performed at the midpoint of adjacent VC probe locations.
  3. The primary method for determining the post-treatment soil strength parameters for production VC work will be from the phi angle correlations in Chapter 7 of the SCDOT Geotechnical Design Manual. These equations are based on either the blow counts as determined from the SPT test, the cone tip resistance as determined from the CPT test, or the horizontal stress index as determined from the DMT test.
  4. The production VC criteria will be based on a minimum applied relative energy for a given time rate. Following completion of the test program, the Geotechnical Engineer will establish criteria for the production VC work. **Production criteria shall be coordinated with the Department.**
- D. Daily Records: Monitoring and logging of VC operations for the test area and production work shall be performed by the Contractor. At a minimum, the following information shall be collected for each VC probe location:
  - a. Equipment details and specifications
  - b. Embankment location
  - c. Probe ID (ie. A-27)
  - d. Start and finish time
  - e. Maximum recorded energy reading
  - f. Depth of treatment
  - g. Comments or unusual observations

A sample monitoring log for the VC work is provided with this specification.
- E. Monitoring of Existing Structures: There are no structures within 500 feet of the planned VC work, and, therefore, a vibration monitoring program is not required for the VC work.
- F. The Contractor shall ensure that procedures and documentation conform to these specifications.

### METHOD OF MEASUREMENT

The acceptance of the VC work shall be solely based on the results from the pre-treatment test program outlined in this specification. The Geotechnical Engineer shall provide to the SCDOT a signed and sealed statement that the soil improvement conforms to requirements of the project design.

### RESTRICTIONS

The Contractor shall be responsible for obtaining the necessary State and municipal permits for the intended construction. The Contractor shall be responsible for the precise delineation of all above and below ground utilities and obstructions and shall accurately mark their layout at the site. The following shall also be listed within this section when applicable:

## EXHIBIT 5 - SPECIAL PROVISIONS

1. Environmental restrictions
2. Work boundaries
3. Hours and days available for construction

### **(95) SECTION 203: BORROW EXCAVATION**

March 6, 2013

Section 203.2.1.8 of the Standard Specifications is amended as follows:

Ensure that all borrow material placed on embankments meet or exceed the requirements for total and effective internal friction angle, cohesion, and total moist unit weight as specified by the geotechnical design engineer of record. These requirements shall be determined by the following tests:

- Internal friction angle determined from either direct shear (AASHTO T236) or triaxial (AASHTO T297) testing on remolded specimens performed by the Contractor.
- Cohesion determined by triaxial (AASHTO T297) testing on remolded specimens performed by the Contractor.
- Total moist unit weight determined by standard proctor test (AASHTO T99) on remolded specimens performed by the Contractor.

Remold all samples to 95 percent of the maximum dry density as determined by the Standard Proctor test (AASHTO T99) and test at normal/consolidation stresses specified by the geotechnical design engineer of record. Conduct shear strength and soil classification testing (AASHTO M145) at the initial selection of the borrow pit, any subsequent changes in borrow pits, and for every 50,000 cubic yards of materials placed. This testing is in addition to the normal embankment and borrow sampling and testing requirements for classification and compaction in accordance with Section 205 of the SCDOT Standard Specifications for Highway Construction that are used for daily acceptance.

Perform additional shear strength testing and/or soil classification testing at no additional cost to the Department when the Department deems that the materials being placed appear to be different from those originally tested. Submit all test results to the RCE for approval prior to use in embankment construction. The RCE will also submit copies of the test reports to the Quality Assurance Engineer at the Office of Materials and Research. Use only qualified laboratories that are appropriately accredited by AASHTO to perform the test procedures required by this specification.

Do not use material derived from Unclassified Excavation to construct embankments unless that material meets the requirements for Borrow Material as stated above.

### **(96) DIVISION 700: MONITORING OF CONSTRUCTION-RELATED EARTHBORNE VIBRATIONS**

Division 100 is expanded as follows:

#### **1.0 DESCRIPTION:**

The project construction will generate vibrations that will travel through the earth, which will subsequently be received or "sensed" by nearby structures and inhabitants. Specific procedures that will generate earthborne vibrations during bridge and roadway construction include (but are not limited to) the installation of piles, earthquake drains, shoring walls, general foundation construction, **exiting bridge removal**, and vibratory compaction of unclassified or borrow excavation. To mitigate the risk of vibration-related damage to nearby structures, this specification outlines the Contractor's responsibility for performing a program of pre-construction condition assessment and vibration monitoring during construction.

## EXHIBIT 5 - SPECIAL PROVISIONS

This specification is based, in part, on AASHTO R 8-96 (2004) *Standard Recommended Practice for Evaluation of Transportation-Related Earthborne Vibrations*. As discussed in AASHTO R 8-96 (2004), humans respond to a much broader range of vibration frequencies and intensities than structures. Intrusive vibration levels can annoy humans at much lower intensities than levels considered critical for structures. Thus, occupants of adjacent properties may perceive that the construction-induced vibrations may present risk to their structures. The recommended safe vibration limits are intended to mitigate the risk of structure damage, and more specifically, reduce the development of “threshold cracks” or cosmetic cracking. Such cracks may appear at lower vibration levels than the level at which architectural or minor structural damage would be expected to occur.

### 2.0 PRE-CONSTRUCTION CONDITION ASSESSMENT:

The Contractor shall retain a geotechnical engineering firm to perform a pre-construction condition assessment to document the conditions of nearby buildings and other sensitive nearby structures prior to the beginning of construction. The assessment shall be performed on all properties adjacent to the project site and any other properties as directed by the Engineer and the Department. The assessment shall include any structures within 300 feet of any vibration inducing construction activity.

The engineering firm retained to perform the pre-construction condition survey shall have a Professional Engineer licensed in the State of South Carolina and experienced in evaluating structural vulnerabilities and vibration monitoring survey. The Contractor shall be responsible for arranging with the property owner and tenants the rights-of-entry to their property in order to conduct the pre-construction assessment and shall document in writing all permissions or objections provided by the property owner/tenants.

The condition assessment shall document all aspects of the structural condition through observations, actual measurements, plan sketches, photographs, and any other data the engineer may deem appropriate. The assessment should include video and photographic documentation of all exteriors and interiors, and installation of crack monitors on cracks that might propagate due to construction vibrations. All documentation of existing building conditions and information concerning the type and location of crack monitors shall be presented to the Engineer Department in a report prior to construction. If a right-of-entry permission to conduct the assessment is denied by the property owner, the condition assessment shall be conducted as a minimum from the exterior of the building/structure (maintaining proper distance using public access locations) and using high quality photographic methods.

### 3.0 CRACK MONITORING DURING CONSTRUCTION:

The Contractor shall provide to the Engineer a Monitoring Plan based on the pre-construction condition assessment prior to commencing monitoring of the buildings/structures. The plan will be reviewed by Engineer and the Department and any comments will be returned to the Contractor within 20 calendar days. The Contractor shall revise the Monitoring Plan as required and resubmit a final plan to the Engineer prior to commencing work. The monitoring plan shall describe the following:

1. Construction methods and equipment that the Contractor chooses to use to achieve project vibration levels.
2. Detailed description of the vibration and structural integrity monitoring systems and if necessary catalog cutouts of monitoring equipment that will be used; how the equipment will be calibrated and re-calibrated if necessary during the life of the project; description and schematics if necessary of how the independent components will function as a system.
3. Identification of the individual, and their contact information, designated to oversee the vibration and crack monitoring system(s); and daily recording activities required in this specification. A brief description of qualifications or resume of the individual is also required.
4. How site monitoring will be performed to continuously record vibration events, including crack monitoring during construction activity. The plan shall describe in reasonable detail the method and means the Contractor will use to identify and monitor existing cracks and document new cracks.

## EXHIBIT 5 - SPECIAL PROVISIONS

For significant cracks or cracks that appear to have a high potential to migrate; it is recommended that the Contractor employ crack monitoring gauges.

5. Details for establishing and deploying an alarm system to announce immediate shut down of all construction activities inducing vibrations which exceed the project vibration criteria.
6. Establish a protocol for the identification of the activity or equipment that caused the project vibration criteria to be exceeded.
7. Detail a protocol including responsible parties to be notified if an exceedance occurs. This includes, but is not limited to the construction superintendent and the Department's lead inspector.
8. For the days where vibration monitoring takes place, daily activity log of vibration activity and crack monitors to ensure the identification of the cause of any vibration event. A daily inspection log shall be maintained either in written or electronic form. All daily logs will be available to the Engineer and the Department for review and a summary of daily logging will be provided in the post-condition survey

During all construction, the Contractor shall perform periodic readings of the crack monitors that were installed during the pre-construction condition assessment. All readings shall be provided to the Engineer and the Department within 48 hours of taking the reading. Provided that the crack readings confirm that vibrations are not contributing to increasing the crack width, the crack monitors may be read once per week. More frequent readings may be directed by the Engineer or the Department during activities that are expected to have greater earthborne vibrations (e.g., pile driving). If the crack readings suggest that vibrations from the project site are contributing to crack width, then the Contractor shall immediately notify the Engineer and the Department and review those activities that are generating the earthborne vibrations. The Contractor and his or her geotechnical firm shall then submit a detailed plan for repair, perform the repair at no cost to the Department and develop and submit for review a revised construction plan to address the vibration problems and minimize further damage and complaints.

### 4.0 VIBRATION MONITORING DURING CONSTRUCTION:

- A. Procedure - The Contractor shall monitor vibrations at no less than four locations along the perimeter of the project during all foundation and embankment construction activities. The locations shall be selected by the Contractor based on the location of the construction activities and their relative position to nearby offsite structures. Depending on proposed construction activities, more than one location may be monitor at the same time. Prior to construction, a plan of the monitoring locations shall be submitted to the Engineer and the Department for acceptance. The locations of the vibration monitors shall be adjusted during construction with acceptance by the Engineer and the Department. The vibration monitors shall be established at the site so that background vibrations may be determined prior to beginning foundation or embankment construction. The sensitivity range of the seismograph shall be selected so that the recording is initiated below the maximum allowable particle velocity shown in Figure 1 and extends above the highest expected intensity. Specific activities of the vibration source shall be indexed in time to allow correlation with the arrivals on the vibration
- B. Project Vibration Criteria - The maximum allowable particle velocity is shown in Figure 1. If the data from the monitors indicate that vibrations are exceeding the established criteria, then the Contractor shall immediately notify the Engineer and the Department and suspend those activities which are generating the earthborne vibrations, until the Contractor and his or her geotechnical firm have developed a revised construction plan to resolve the problem. The problem shall be resolved at no additional cost to the Department.
- C. Instrumentation – The vibration monitors shall consist of digital seismographs that display the particle velocities and associated frequencies plotted against the criteria for this project (i.e., Figure 1). Each seismograph shall contain geophones with response capability in three mutually perpendicular axes or components: one vertical and two horizontal (radial and transverse). The frequency response of the geophones shall be linear from at least 4 Hz to more than 200 Hz. The sensitivity shall range from less than 0.02 in/sec to more than 5.0 in/sec. The BlastMate III by Instantel is one type of seismograph that is suitable for this project.

## EXHIBIT 5 - SPECIAL PROVISIONS

- D. Calibration and Instrument Use - The Contractor shall field calibrate the vibration monitors before the start of each recording period. The transducer shall be positioned with the longitudinal axis toward the vibration source. Transducers must be adequately coupled with the ground. Operation of all vibration monitors shall be in accordance with the instrument manufacturer's instructions and recommendations. Vibration records shall be collected in waveform plot or strip chart plot. The peak vector sum of the particle velocity in longitudinal, transverse, and vertical planes shall be shown along with the respective dominant or principle frequencies. The highest recorded particle velocity (i.e., the vector sum of the three orthogonal directions), when indexed to a particle vibration event, shall be reported as the peak particle velocity. The recorded peak particle velocity shall be compared to criteria appropriate for the subject of concern.
- E. Complaints - In the event of a complaint, the Contractor shall immediately contact the Engineer and the Department and review those construction activities that are inducing vibrations into the earth. The Contractor shall prepare a report documenting all relevant data such as the time and date presented in the complaint, a description of the construction activities during the subject time/date, data from the monitoring instruments for the subject time/date, complaint information and a description (including photographs, if possible) of the alleged damage. The Contractor and his or her geotechnical firm shall then submit a detailed plan for repair, perform the repair at no cost to the Department and develop and submit for review a revised construction plan to address the vibration problems and minimize further damage and complaints.

### 5.0 CONSTRUCTION MONITORING RESULTS

In the event that crack or vibrations monitoring results indicate vibration damage is possible or eminent during construction activities, the Contractor shall immediately cease those construction activities and contact the Engineer and the Department and review those construction activities that are inducing vibrations into the earth. The Contractor shall suspend those activities until the Contractor submits a revised construction plan to resolve the problem and is approved by the Engineer and the Department. The problem shall be resolved at no additional cost to the Department.

Public complaint of vibration damage or eminent vibration damage during construction activities shall be brought to the attention of the Engineer and the Department. The Contractor shall prepare and submit a report documenting all relevant data such as the time and date presented in the complaint, a description of the construction activities during the subject time/date, data from the monitoring instruments for the subject time/date, complaint information and a description (including photographs, if possible) of the alleged damage. The Department shall review the report and evaluate if the construction activities caused the alleged damage. If the Contractor's construction activities caused damage, the Contractor shall submit a detailed plan for repair, perform the repair at no cost to the Department and develop and submit for review a revised construction plan to address the vibration problems and minimize further damage and complaints.

The Contractor shall also provide monthly reports containing the results of the crack monitors, vibration monitors, and any public complaints during those activities that generate earthborne vibrations, including (but not limited to) bridge demolition, foundation installation, and vibratory compaction. The reports shall document that the Contractor is providing the work described by this specification.

### 6.0 POST-CONSTRUCTION CONDITION ASSESSMENT

The Contractor shall perform a post-construction condition assessment and analysis at the designated adjacent building/structures to determine if any structural changes are the result of the construction activity. The Contractor shall provide the Engineer and the Department with a copy of all post construction survey reports, daily log summaries for vibration and crack monitors, and analysis documents comparing pre and post structural condition prior to contract acceptance.

### 7.0 METHOD OF MEASUREMENT:

In addition to the pre-construction condition assessment report, the Contractor shall also provide monthly reports containing the results of the crack monitors and vibration monitors during those activities that



**EXHIBIT 5 - SPECIAL PROVISIONS**

generate earthborne vibrations, including (but not limited to) ground improvement and foundation construction. The reports shall document that the Contractor is providing the work described by this specification.

**BASIS OF PAYMENT:**

Payment shall be made in proportion with the percent of the project that is complete. Final payment of the remaining lump sum balance shall be made when vibration monitoring is complete as approved by the Engineer and the Department. Payments shall be made under:

Item No.	Pay Item	Pay Unit
1075001	MONITORING OF CONSTRUCTION-RELATED EARTHBORNE VIBRATIONS	Lump Sum

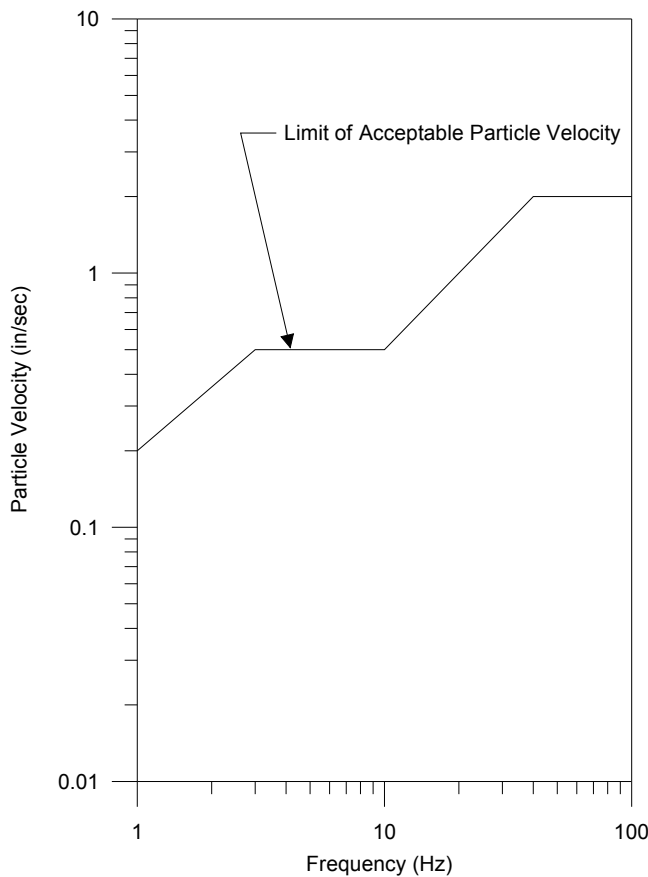

Figure 1. Vibration Criteria (adapted from AASHTO R8-96)

**(97) SECTION 729: NAVIGATION LIGHTS FOR BRIDGE**

**729-1 Description.**

## EXHIBIT 5 - SPECIAL PROVISIONS

Furnish and install navigation lighting systems, including all wiring, conduit, wiring devices, transformers, enclosures, grounding system, controls, protective devices, lights, etc., in compliance with Code of Federal Regulations (CFR), Title 33, Part 118, which is further clarified in U.S. Coast Guard (USCG) Publication "A Guide to Bridge Lighting". Navigation lights must operate from sunset to sunrise and during periods of low visibility.

### **729-2 Coordination of Electrical Work.**

Use experienced personnel in the type of work required by the Contract Documents to provide a complete and satisfactory fitting and fully operational installation. Perform all electrical work either by, or under the immediate supervision of an electrical journeyman. Schedule and arrange electrical work in a neat, well-organized manner without interference with the work scheduling of other trades.

### **729-3 Materials and Equipment.**

Meet the equipment and material requirements as shown in the Contract Documents. Furnish and install only materials and equipment of new stock meeting ANSI, NEC, NEMA, and UL requirements, and approved by the Engineer, except where the Contract Documents allow or specify the use of other than new equipment.

Furnish and install marine type products manufactured of corrosion resistant materials.

Furnish and install only fasteners manufactured from ASTM 316 stainless steel with yield strength 35,000 psi or higher.

Furnish and install ASTM 300 series stainless steel conduit straps or hangers held at not less than two points.

Furnish and install framework for supporting boxes, switches, and other externally mounted electrical devices fabricated from ASTM A709 Grade 36 hot-dip galvanized structural steel.

### **729-4 Navigation Lights and Aids.**

**729-4.1 Navigation Lights:** Equip all navigation lights with a LED array with a minimum of 50,000 hour life and bright enough to meet the visibility requirements of CFR Title 33, Part 118. Mount LED arrays on an internal shock and vibration isolator. Provide, in the circuit, a lightning surge suppressor capable of absorbing multiple strikes without replacement. Provide special power supply to provide current limited DC voltage to the LED array.

Furnish and install fixtures with unpainted housings of heavy duty cast aluminum or bronze construction with a 1-1/2 to 2 inch threaded conduit opening on the bottom. Use only marine type mounting boxes with minimum 3/4 inch conduit opening. Furnish and install fixtures with lenses that are standard marine molded, single-piece fresnel type, rigid, heat resistant glass or U.V. resistant polycarbonate and inside diameter of 7 to 8 inch. Furnish all stainless steel closure bolts, lens tie rods, and attachment hardware for a complete and accepted installation.

Furnish and install Pier/Fender Lights, Center Channel Lights and Channel Margin Lights with cast aluminum or bronze swivel assembly and mounting bracket, complete with stainless steel pivot, watertight "O" ring seal, bronze bearings, cable entrance fitting, and stainless steel service chain rated for a minimum 225 pounds load. Use a 1-1/2 or 2 inch galvanized pipe or stainless steel pipe as a hanger stem with automatic lock at service and operating positions. Furnish and install a 60% counterweight if stem exceeds 5 feet in length.

Ensure the Pier/Fender Light is equipped with a red 180 degree lens, the Center Channel Light is equipped with a green 360 degree lens and the Channel Margin Light is equipped with a red 180 degree lens.

**729-4.2 Clearance Gauge Lights: If required by the USCG,** furnish and install one-piece die-cast aluminum fixture housing fitted with watertight gasket, stainless steel hinges and fasteners, and adjustable aiming capability, equipped with a 120 Vac, 50 watt, high-pressure sodium lamp. Use a heavy cast aluminum connection box body and cover with stainless steel swing bolts, watertight gasket and provisions for mounting to a platform with four stainless steel lag bolts or screws.

### **729-5 Disconnect Switches.**

Furnish and install switches that are HP rated and meet Federal and NEMA Specifications with NEMA Type 4X (stainless steel) enclosures, and with metal factory nameplates that are front cover mounted and contain a permanent record of switch type, catalog number, and HP rating. Provide switch

## EXHIBIT 5 - SPECIAL PROVISIONS

with visible blades, reinforced fuse clips, and nonteasible, positive, quick make-quick break mechanisms. Provide switch assembly plus operating handle as an integral part of the enclosure base.

Use switches with defeat able door interlocks that prevent the door from opening when the operating handle is in the ON position, and whose handle position is easily recognizable and is padlockable in the OFF position. Use heavy-duty switches with line terminal shields.

**729-5.1 Fusible Switch Assemblies:** Furnish and install NEMA KS 1 type; load interrupter enclosed knife switch. Provide fuse Clips that are designed to accommodate Class R fuses.

**729-5.2 Non-fusible Switch Assemblies:** Furnish and install NEMA KS 1; HD type, load interrupter enclosed knife switch.

**729-5.3 Enclosures:** Furnish and install NEMA KS 1 type enclosure.

**729-5.4 Installation:** Install disconnect switches where indicated in the Contract Document or where required by the Engineer. Use separate conduits for line and load conductors. Install fuses in fusible disconnect switches.

### **729-6 Supporting and Mounting Devices.**

Ensure the sizes, and types of anchors, fasteners and supports used are adequate to carry the load of the equipment and conduit, including the wire in the conduit.

Space conduit supports to avoid conflicts with reinforcing steel at 5 feet maximum. For concrete mounting, use anchor bolts and all matching parts and tools recommended by and provided by the same manufacturer, as well as suitable for dynamic loading caused by vibration due to traffic. To mount conduit supports and pull boxes, use 1/4 inch diameter anchor system.

To mount channel lights use minimum 1/2 inch diameter anchor system with 3-1/2 inch embedment and 8 inch edge distance.

Use ASTM 300 series stainless steel conduit straps or hangers held at not less than two points.

Do not use powder-actuated anchors. Do not drill or weld structural steel members. Do not use bolts smaller than 1/4 inch in diameter except as may be necessary to fit the mounting holes in small and light devices. Install surface-mounted boxes with minimum of three anchors.

### **729-7 Conduit.**

**729-7.1 General:** Furnish and install conduit in the quantities and sizes required to complete the work as shown in the Plans and as required by NEC. Use products listed and classified by UL as suitable for purpose specified and shown. Do not use non-metallic flexible conduit, aluminum, or electrical metallic tubing (EMT).

**729-7.2 Liquid-Tight Flexible Metal Conduit:** Furnish and install, liquid-tight flexible metal conduit of interlocked steel construction with PVC jacket, and fittings meeting the requirements of ANSI/NEMA FB 1.

**729-7.3 PVC Conduit:** Furnish and install, schedule 80 PVC 3/4 inch minimum diameter conduit meeting the requirements of ASTM D1785 and NEMA TC 2 and fittings and conduit bodies meeting the requirements of ASTM D2467 and NEMA TC 3.

**729-7.4 Fiberglass Reinforced Epoxy Conduit:** Furnish and install rigid non-metallic fiberglass reinforced epoxy conduit and fittings manufactured in accordance with the applicable standards of ANSI and NEMA TC-14B.

Ensure the conduit has a bell and spigot type coupling and the coupling seal is made rigid by using an adhesive that will provide a water and vapor tight joint with a tensile strength equal to that listed for the conduit. An alternative type assembly may be used by applying a triple seal ribbed gasket of water resistant rubber material. Ensure the gasket is held firmly in place with a compatible adhesive.

Ensure that all fittings, adapters, and bends are manufactured from the same materials as the conduit and conform to the dimensional requirements of NEMA TC-14.

Use only fiberglass reinforced epoxy conduit and fittings made by the same manufacturer to insure proper fit and assembly, listed on the UL approved list and labeled for Type I service sizes 2 to 6 inches.

Ensure that each piece of conduit and fitting is clearly marked with durable contrasting ink, stenciled with the following:

1. Nominal size,
2. Bends to show the degree and radius of curvature,
3. Type: SW or HW,

## EXHIBIT 5 - SPECIAL PROVISIONS

### 4. Manufacturers' name or trademark.

**729-7.5 Installation:** Install conduit in accordance with National Electrical Contractors Association (NECA) "Standard of Installation" and manufacturer's instructions.

Arrange supports to prevent misalignment during wiring installation. Support conduit using straps, lay-in adjustable hangers, clevis hangers, and split hangers. Do not support conduit with wire or perforated pipe straps, plastic straps, or plastic hangers. Ensure that all wire used for temporary supports is removed upon completion of installation.

Install an expansion fitting for specified PVC conduit at all structure expansion joints or where movement between adjacent sections of conduit is expected. Provide certification to the Engineer from the manufacture that the expansion fitting meets the following minimum requirements: compatibility with the connected conduits, water proof, UV protected, and allows longitudinal movement equal to that of the expansion joint or movement expected.

Route exposed conduit parallel and perpendicular to walls or route conduit in the railings. Install conduits to be continuous and watertight between boxes or equipment. Protect conduits at all times from the entrance of water and other foreign matter by being capped or well plugged overnight and when the work is temporarily suspended.

Cut conduit square using saw or pipe cutter; de-burr cut ends. Bring conduit to shoulder of fittings; fasten securely. Use conduit hubs to fasten conduit to metal boxes. Do not install more than the equivalent of three 90 degree bends (total 270 degrees) between boxes. Use conduit bodies to make sharp changes in direction such as around diaphragms.

Join PVC conduit using cement recommended by manufacturer. Wipe PVC conduit dry and clean before joining. Apply full even coat of cement to entire area inserted in fitting. Allow joint to cure for a minimum of 20 minutes before pulling conductors.

Do not use flexible conduit extensions greater than 24 inches in length. Ensure that all flexible conduit extensions are equipped with bonding jumpers.

Do not allow moisture traps; provide pull box with drain fitting at low points in exposed conduit system.

### **729-8 Wiring.**

**729-8.1 General:** Do not use aluminum conductors. Use only SE or RHW on incoming service and use single conductor with XHHW insulation, unless otherwise noted in the Plans.

Do not use wire smaller than No. 12 AWG.

Furnish insulated conductors of seven or nineteen strand copper with a minimum 98% conductivity and connector accessories for copper in sufficient quantities for a complete installation.

**729-8.2 Installation:** Use pull boxes wherever necessary to facilitate the installation of the conductors. Do not use condulets for pulling more than ten conductors or for branching conductors.

Splice only in accessible boxes. Make lug connections with high pressure indent connector tools as recommended by the lug manufacturer. Make splices and taps to carry full ampacity of conductors without perceptible temperature rise. Tighten all connections to manufacturer's recommendations. Tape uninsulated conductors and connectors with electrical tape to 150% of the insulation value of conductor. Ensure all splices are waterproof.

Use solderless pressure connectors with insulating covers for No. 8 AWG and smaller wire splices and taps. Use split bolt connectors for No. 6 AWG and larger wire splices and taps.

Pull all conductors into a raceway at the same time. Use soap base wire pulling lubricant for pulling No. 4 AWG and larger wire.

**729-8.3 Testing:** Test each circuit for continuity and short-circuits for its complete length before being connected to its load.

Inspect wire and cable for physical damage and proper connection.

# **EXHIBIT 6**

## **SUPPLEMENTAL SPECIFICATIONS AND FORMS**

**SUPPLEMENTAL SPECIFICATIONS AND FORMS  
FOR**

**Replacement of US 701 Bridges over the Great Pee Dee River, Great Pee Dee  
Overflow, and Yauhannah Lake  
Horry / Georgetown Counties**

**TABLE OF CONTENTS**

**SUPPLEMENTAL SPECIFICATIONS.....2**

ERRATA TO 2007 STANDARD SPECIFICATIONS FOR HIGHWAY CONSTRUCTION .....2

CLAIMS PROCEDURE.....6

SOUTH CAROLINA MINING ACT .....11

**CRITICAL PATH METHOD CONSTRUCTION SCHEDULES.....12**

PROMPT PAYMENT CLAUSE.....32

AS-BUILT CONSTRUCTION PLANS .....33

TRANSPORTATION AND DELIVERY OF MIXES .....34

HIGH PRESSURE METHOD FOR REMOVAL OF PAVEMENT MARKINGS.....35

AUTOMATED FLAGGER ASSISTANCE DEVICE SYSTEM (AFAD).....37

**TRAFFIC CONTROL – HOLIDAY RESTRICTIONS.....42**

**DISTRICT 5 LANE CLOSURE RESTRICTIONS.....44**

ADHESIVE/EPOXY BONDED ANCHORS AND DOWELS.....58

CONCRETE BATCHING AND MIXING.....62

CONCRETE STRUCTURES – PREFORMED JOINT FILLER .....63

GEOTEXTILE FOR DRAINAGE FILTRATION .....64

CRANE SAFETY.....66

EROSION CONTROL MEASURES .....67

EROSION CONTROL .....69

GROUT FOR POST TENSIONING AND PRESTRESSED CORED SLABS .....70

TRAINING REQUIREMENTS FOR CONTRACTORS / SUBCONTRACTORS).....71

**CLAIM CERTIFICATION.....74**

**CONTRACTOR NOTICE OF CLAIM - FORM 616.....75**

**PILE AND DRIVING EQUIPMENT DATA FORM.....77**

**DRILLED SHAFT FORMS .....78**

**ERRATA TO 2007 STANDARD SPECIFICATIONS FOR HIGHWAY CONSTRUCTION**

Make the changes listed below to correct errata in the SCDOT *2007 Standard Specifications for Highway Construction*:

**DIVISION 100 GENERAL PROVISIONS**

**SECTION 101 DEFINITIONS AND TERMS**

**Subsection 101.2 Abbreviations and Acronyms**

Amend the table of **SCDOT OFFICIALS AND OFFICES** as follows:

DELETIONS		REPLACEMENTS	
<del>BDE*</del>	<del>Bridge Design Engineer</del>	PSE*	Preconstruction Support Engineer
<del>BDGE*</del>	<del>Bridge Design Geotechnical Engineer</del>	GDSE*	Geotechnical Design Support Engineer
<del>SHE*</del>	<del>State Highway Engineer</del>	DSE*	Deputy Secretary for Engineering

\*Wherever it appears in the text, replace the deleted abbreviation with the new abbreviation.

**SECTION 102 BIDDING REQUIREMENTS AND CONDITIONS**

**Subsection 102.8 Irregular Bids**

Paragraph 2, item E, first sentence; delete the word "the" after the word "When".

**SECTION 105 CONTROL OF WORK**

**Subsection 105.6 Cooperation with Utilities**

Paragraph 1, last sentence; change the word "THE" to "the".

**DIVISION 200 EARTHWORK**

**SECTION 202 REMOVAL OF STRUCTURES AND OBSTRUCTIONS**

**Subsection 202.5 Measurement**

Paragraph 5, second bullet; change the words "Brick sidewalk" to "Concrete, brick or stone sidewalks".

**SECTION 204 STRUCTURE EXCAVATION**

**Subsection 204.2.1.2 Structure Excavation for Culverts**

Paragraph 1, at the end of the first sentence; change "**Subsection 204.4**" to "**Subsection 204.5**".

**DIVISION 400 ASPHALT PAVEMENTS**

**SECTION 401 HOT MIXED ASPHALT (HMA) PAVEMENT**

**Subsection 401.2.1.2 Liquid Anti-Stripping Agent**

Paragraph 1, first sentence; delete the period at the end of the sentence and add "and SC-M-406."

**Subsection 401.2.5 Material for Full Depth Patching**

Paragraph 1, delete and replace with the following:

"Use an approved SCDOT Intermediate Type C mix for all Full Depth Patching."

**Subsection 401.5 Measurement**

**EXHIBIT 6 - SUPPLEMENTAL SPECIFICATIONS AND FORMS**

After paragraph 10, add the following paragraph:

- 11 The measurement of Prime Coat is the number of gallons of asphalt material applied to the completed and accepted base course.

**Subsection 401.6 Payment**

After paragraph 12, add the following paragraph:

- 13 "The payment for Prime Coat is at the contract unit price for Prime Coat and includes compensation for all labor, equipment, tools, maintenance, and incidentals necessary to complete that work."

**Subsection 401.6 Payment**

Paragraph 13, **Table of Pay Items**

Change paragraph reference number "13" to "14" and add the following Pay Item:

<b>Item No.</b>	<b>Pay Item</b>	<b>Unit</b>
4010005	Prime Coat	GAL

**SECTION 403 HMA SURFACE COURSE**

**Subsection 403.5 Measurement**

Paragraph 1, first sentence; change "HMA Intermediate Course" to "HMA Surface Course".

**Subsection 403.6 Payment**

Paragraph 1, first sentence; change "HMA Intermediate Course" to "HMA Surface Course".

**SECTION 407 ASPHALT SURFACE TREATMENT – DOUBLE TREATMENT**

**Subsection 407.5 Measurement**

Paragraph 1, first sentence; add the word "is" after "(Double Treatment Type (1, 2, 3, 4, or 5))".

**SECTION 408 ASPHALT SURFACE TREATMENT – TRIPLE TREATMENT**

**Subsection 408.5 Measurement**

Paragraph 1, first sentence; add the word "is" after "(Triple Treatment Type (1 or 2))".

**DIVISION 600 MAINTENANCE AND TRAFFIC CONTROL**

**SECTION 625 PERMANENT PAVEMENT MARKINGS  
FAST DRY WATERBOURNE PAINT**

**Subsection 625.2.2.4.11 Lead Content**

Paragraph 1, first sentence; change 6% to 0.06%.

**SECTION 627 THERMOPLASTIC PAVEMENT MARKINGS**

**Subsection 627.4.10 Inspection and Acceptance of Work**

Paragraph 2, first sentence; change "period of 90 days" to "period of 180 days".

**Subsection 627.4.10 Inspection and Acceptance of Work**

Paragraph 2, second sentence; change "90-day observation period" to "180-day observation period".

**Subsection 627.4.10 Inspection and Acceptance of Work**

Paragraph 3, first sentence; change "90-day period" to "180-day period".



## DIVISION 700 STRUCTURES

### SECTION 709 STRUCTURAL STEEL

#### Subsection 709.4.3.5.2 Submittals and Notification

Paragraph 1, delete the last two sentences and replace them with, "The Department's review and acceptance are required before any field welding will be permitted."

#### Subsection 709.6.3 Pay Items (page 650)

Subsection heading number; change subsection heading number from "709.6.3" to "709.6.4".

### SECTION 712 DRILLED SHAFTS AND DRILLED PILE FOUNDATIONS

#### Subsection 712.4.4 Dry Construction Method

Paragraph 2, last sentence in A; change "*Drilled Shaft Report*" to "*Drilled Shaft Log*".

#### Subsection 712.4.10.4 Excavation Cleanliness

Paragraph 1, last sentence; change "*Drilled Shaft Report*" to "*Drilled Shaft Log*".

#### Subsection 712.4.10.6 Shaft Load Test

Change first paragraph reference number from "2" to "1".

#### Subsection 712.6.10 Drilled Pile Set-Up

Insert paragraph reference number "1" to the left of the first paragraph.

### SECTION 723 DECK JOINT STRIP SEAL

#### Subsection 723.1 Description

Insert paragraph reference number "3" to the left of the third paragraph.

### SECTION 726 BRIDGE DECK REHABILITATION

#### Subsection 726.4.1 General

Insert paragraph reference number "1" to the left of the first paragraph.

#### Subsection 723.4.6 Full Depth Patching (page 790)

Subsection heading number; change subsection heading number from "723.4.6" to "726.4.6"

### SECTION 727 CROSSHOLE SONIC LOGGING OF DRILLED SHAFT FOUNDATIONS

#### Subsection 726.6 Payment (page 807)

Subsection heading number; change subsection heading number from "726.6" to "727.6"

## DIVISION 800 INCIDENTAL CONSTRUCTION

### SECTION 805 GUARDRAIL

#### Subsection 805.5 Measurement

Paragraph 4; amend as follows:

"The quantity for the pay item 8053000 Additional Length Guardrail Post is the length of required post installed in excess of the standard length post based on the system being installed, measured by the linear foot (LF), complete, and accepted."

**SECTION 815 EROSION CONTROL**

**Subsection 815.1 Description**

Paragraph 1, first sentence; change "temporary flexible pipe" to "temporary pipe".

**Subsection 815.5 Measurement**

Paragraph 13; delete the first sentence and replace it with the following sentence:  
"The quantity for Temporary Pipe Slope Drains is measured and paid for in accordance with **Subsections 803.5** and **803.6** respectively."

**Subsection 815.5 Measurement**

Delete paragraph 19.

**Subsection 815.6 Payment**

After paragraph 15, add the following paragraph:

- 16 Payment for Removal of Silt Retained by Silt Fence is full compensation for removing and disposing of sediment deposits accumulated by silt fences as specified or directed and includes all materials, labor, equipment, tools, supplies, transportation, and incidentals necessary to fulfill the requirements of the pay item in accordance with the Plans, the Specifications, and other terms of the Contract.

**Subsection 815.6 Payment**

Change original paragraph number "16" to "17".

**Subsection 815.6 Payment**

Pay Item table; change the Unit for Item No. 8156214 to "EA".

**INDEX:**

Amend as follows:

Page I-3, after "Bridge Deck Rehabilitation, measurement and payment:"  
Delete page 807.

Page I-12, after "Letting:"  
Replace page 19 with page 9.

Page I-13, after "Overhead Sign Structure:"  
Replace page 488 with page 495.

Page I-15, after "Proof Rolling:"  
Delete page 98.

Page I-18, after "Structural Steel, turned and ribbed bolts:"  
Replace page 624 with page 625.

Page I-19, after "Waterproofing, bridge deck:"  
Delete page 907.

Page I-20, after "Working Drawings:"  
Replace page 543 with page 779.

June 2, 2014

**CLAIMS PROCEDURE**

**1. Scope of Procedure**

The following claims procedure covers all claims for additional time or compensation arising under this contract. The claims procedure is non-binding and is a condition precedent to litigation or any other form of dispute resolution. All communications testimony and all documents prepared for this procedure by either party from the time of filing the CERTIFICATE OF CLAIM, per section 105.16.8 of the 2007 Standard of Specifications for Highway Construction, to the conclusion of the procedure shall be deemed to be settlement negotiations and not admissible in litigation or any other dispute resolution procedure. If at the conclusion of this procedure the claim has not been resolved, litigation may be pursued through the South Carolina Circuit Court. Contractor waives all rights to a jury trial and agrees that all litigation matters shall be heard non-jury and venue for any action shall be in South Carolina Circuit Court in Richland County.

**2. Continuation of Work**

At all times during the pendency of a claim under this procedure, the contractor shall continue work pursuant to the contract and as directed by the engineer as provided by the contract. If the contractor fails to continue work, it may be declared delinquent in its work as provided by §108.8 of the South Carolina Standard Specifications for Highway Construction ("Standard Specifications").

**3. Submission of Claim**

The notice of claim and claim shall be submitted in accordance with §105.16 of the Standard Specifications. The notice of claim does not trigger this claims procedure. The claims procedure is initiated when the contractor submits a written fully detailed CERTIFICATE OF CLAIM to the resident construction engineer ("RCE"). The claim shall contain, at a minimum, the information required by §105.16.7 of the Standard Specifications. The RCE shall immediately forward a copy of the claim to the District Engineering Administrator ("DEA") for resolution. If the DEA is unable to resolve the claim within thirty (30) days of receipt, the DEA shall forward it immediately to the Director of Construction ("DC"), together with documents supporting the Department's position. The DEA shall also submit the supporting documents to the contractor at this time. The DC shall investigate the claim and attempt to resolve it by mutual agreement with the contractor. If it cannot be resolved, then the DC shall make a decision and forward the decision to the contractor, no later than thirty (30) days after receipt by the DC. The contractor shall notify the DC within five (5) days of receipt of the DC's decision whether the contractor accepts or rejects the decision.

For all claims under Fifty Thousand Dollars (\$50,000.00) the DC's decision shall be final and shall conclude the claims procedure. For the purpose of determining if a time only claim may be submitted to the Board, the value of a time only claim shall be deemed to be the number of days requested multiplied by the contract daily rate for liquidated damages. The contractor does not have a right to submit claims under \$50,000.00 to the Dispute Review Board. If the contractor does not accept the DC's decision on its claim of less than \$50,000.00, then its remedy is litigation in the South Carolina Circuit Court for Richland County as set forth in Paragraph 1 of this Claims Procedure or other mutually agreeable dispute resolution procedures.

For all claims in excess of \$50,000.00, if the contractor rejects the DC's decision or fails to respond to the decision, the DC shall forward the claim to the Dispute Review Board.

**4. Dispute Review Board**

On designated contracts an *Ad Hoc* Dispute Review Board will be established to hear claims on that contract. On other contracts, claims will be heard by a Standing Dispute Review Board. All Board Members shall be neutral and unbiased. No party shall have any *ex parte* communication with any Board Member.

a. Ad Hoc Dispute Review Board

On designated contracts a Dispute Review Board shall be established within sixty (60) days after the Preconstruction Conference. The *Ad Hoc* Dispute Review board shall consist of one member selected by the Department, one member selected by the contractor, and a third member selected by the first two members. The third member shall be the chairperson of the *Ad Hoc* Dispute Review Board. The selection of qualified *Ad Hoc* Dispute Review Board members shall be made in accordance with the Dispute Review Board rules and procedures. (See Section 6).

b. Standing Dispute Review Board

A Standing Dispute Review Board shall be established upon implementation of this claims procedure. The Standing Dispute Review Board shall consist of one member selected by the Department, one member selected by the Director of Heavy and Highway Division of the Associated General Contractors (Carolina's Branch), and a third member selected by the first two members. The third member shall be the chairperson of the Standing Dispute Review Board. The selection of qualified Standing Dispute Review Board members shall be made in accordance with the Dispute Review Board rules and procedures. (See Section 6). Each member shall serve a three (3) year term and the terms shall be staggered. The terms for the initial Board members shall be as follows:

- Department Member - 1 year
- AGC member - 2 years
- Third member - (Chairperson) 3 years

Each member is limited to two (2) terms. The initial abbreviated terms of the Department and AGC members do not count as a term.

**5. Hearing Procedure**

When the DC forwards the claim to the Dispute Review Board, the DC shall provide three (3) copies of the claim and three (3) copies of all documents submitted by the contractor and the DEA. The DC shall notify both parties that the claim has been submitted to the Board.

Within fifteen (15) days of notice of submission of the claim to the Board, the contractor may submit to the DC five (5) copies of any additional documentation supporting its claim. The DC shall immediately forward three (3) copies to the Board, one (1) copy to the DEA, and the DC will keep one (1) copy.

Within fifteen (15) days of receipt of the contractor's supplemental documentation, the DEA may submit to the DC five (5) copies of its additional documentation. The DC shall immediately submit three (3) copies to the Dispute Review Board, one (1) copy to the contractor, and the DC will keep one (1) copy. Upon submission of supplemental documentation, the party shall notify the Board whether it requests a hearing.

The Dispute Review Board shall review all documents and notify the parties of what additional documents, if any, it requires. The Dispute Review Board shall schedule a hearing at either party's request or may schedule a hearing at its own discretion. However, if a hearing is requested, it must be held no later than sixty (60) days after the DC submits the claim to the Dispute Review Board. The location of the hearings shall be determined by the Board. While extensions of these deadlines are discouraged, the Dispute Review Board shall have authority to extend any of the above deadlines for just cause.

The Dispute Review Board shall have full authority to establish guidelines and procedures for the investigation of a claim. The entire process is intended to be flexible and the Board is encouraged to adapt the process to individual circumstances presented by particular disputes.

**EXHIBIT 6 - SUPPLEMENTAL SPECIFICATIONS AND FORMS**

In the interest of timely resolution of all claims, the Board shall conduct all hearings and issue its final decision within ninety (90) days of receipt of the claim.

The Dispute Review Board Chairperson shall direct all meetings and hearings. Presentation of evidence shall be in accordance with the Dispute Review Board's rules and shall not be bound by judicial rules of evidence. Documents and testimony shall be presented in the order, manner and degree of detail that the Dispute Review Board deems most efficient and probative. Each party shall be allowed to make a brief initial presentation and to rebut any factual assertion by another party; however, the Dispute Review Board shall determine when enough evidence has been presented and it may limit the presentation of any documentation or testimony that it deems not relevant or redundant. At the Board's option, testimony may be required to be given under oath and the oath shall be administered by the Chairperson.

Legal counsel for either party may be present at meetings or hearings as observers only. If a party intends to have its counsel present at a hearing, it must provide at least ten (10) days notice prior to the meeting or hearing. Legal counsel may not speak on behalf of a party, unless requested by the Board. Counsel may not examine or cross-examine witnesses, object to questions or statements during meetings or make legal motions or arguments during meetings or hearings. The Board, by majority vote, may suspend legal counsel's privilege to attend meetings or hearings.

The Dispute Review Board shall issue to the contractor and the Deputy Secretary for Engineering a written recommendation with an explanation of the results as soon as reasonably possible following the conclusion of the hearing. However, in no event shall the Board take more than ninety (90) days from receipt of claim to conduct hearings and issue a recommendation. The Board is encouraged to reach a unanimous decision; however, it may provide a majority recommendation. The minority Board Member may provide a written explanation of his position. The Board shall provide further explanation of its decision if requested by either party within ten (10) days of the receipt of the decision. Issuance of the Board's recommendation concludes the claims procedure.

The parties may settle at any time during the procedure. If the dispute is resolved prior to issuance of a recommendation, the DC shall immediately notify the Board.

If at the conclusion of this procedure the claim has not been resolved, litigation may be pursued in South Carolina Circuit Court for Richland County as set forth in Paragraph 1 of this Claims Procedure.

The Board members shall not be compelled to testify, give any type of statements, nor produce any documents or evidence submitted at the DRB hearing in any subsequent proceedings or litigation.

**6. Dispute Review Board Rules and Procedures**

**a. Qualifications of Dispute Review Board Members**

- (1) All Dispute Review Board Members shall have substantial experience in highway or bridge design and construction. This experience may be technical, administrative or legal. The goal is to have a Board with the technical and administrative skills and experience that will promote confidence in its decisions.
- (2) No Dispute Review Board Member shall be employed currently or within the last three (3) years with the Department, any contractor (currently or in the past pre-qualified with the Department), or any design consultant that has worked for the Department within the last three (3) years.
- (3) No Dispute Review Board Member shall have any financial or ownership interest in any party to the contract nor any design consultant or major subcontractor.

**b. Selection of Dispute Review Board Members**

**(1) Ad Hoc Dispute Review Board**

**EXHIBIT 6 - SUPPLEMENTAL SPECIFICATIONS AND FORMS**

Within twenty (20) days after the Preconstruction Conference, the contractor and Department shall each submit a list of three (3) proposed Dispute Review Board Members to each other.

The contractor shall send its list to the DC. The Department shall send its list to the contractor's designated representative. Within ten (10) days after receipt of the list, the contractor shall select one member from the Department's list and the Department shall select one member from the contractor's list and notify the other party of their selection. The DC shall notify the two selected members that they must select a third member within twenty (20) days. The DC shall also provide a copy of the claims procedure to the two (2) selected members. Within twenty (20) days of the selection of the first two members, the first two members shall select the third member and the third member shall be the chairperson of the Dispute Review Board. The third member does not have to come from the lists provided by the parties.

If the first two members are not able to agree on a third member within twenty (20) days of their selection, then the third member shall be selected by the American Arbitration Association, within ten (10) days after it is determined that the first two members cannot agree on a third member. Upon selection of the third member, the DC shall provide a copy of the claims procedure to the third member.

**(2) Standing Dispute Review Board**

The selection process for Standing Dispute Review Board Members shall begin at the appropriate time in order to allow completion of the Member selection by beginning of the term. The selection process shall be as provided in Section 4(b); otherwise it shall be the same as for the *Ad Hoc* Board.

**c. Replacement of Board Members**

Each party may elect to replace its Board Member at any time with a showing of reasonable justification. The Chairperson of the Board may be replaced at any time with the consent of both parties. If any Board Member is replaced, the new member shall be selected in the same manner in which the original appointment had been made.

If disputes are pending at the end of a member's term, the existing Board shall complete its hearing on the disputes and issue a decision.

**d. Costs**

Board Members shall be paid a reasonable hourly rate or salary for their services. Each party shall negotiate the fee arrangements with the Member it selects, however, the other party must agree on the rate. Both parties shall agree on the fee arrangement for the Chairperson.

Board Members shall be reimbursed for out-of-pocket expenses including, but not limited to, travel, copying, telephone, clerical services, and mailings. The Board Members shall be allowed reimbursement of actual expenses for meals up to the daily maximums set forth in the Department's Regulations for Reimbursement of Travel and Subsistence Expenses and actual lodging costs provided they stay in hotels approved by the Department and they obtain a government rate. Board Members must provide documentation for all expenses.

The parties shall share all Board Members' fees and expenses equally. The total fees and expenses to hear each claim shall not exceed the following maximum amounts unless otherwise agreed to by both parties in writing (one claim shall constitute all issues submitted to the Dispute Review Board at one (1) time):

Claim Amount

Cumulative Total

EXHIBIT 6 - SUPPLEMENTAL SPECIFICATIONS AND FORMS

\$ 50,000 - \$499,999.99.....	\$15,000.00
\$500,000.00 - \$999,999.99.....	\$25,000.00
\$1 million - \$4,999,999.99.....	\$40,000.00
over \$5 million.....	\$75,000.00

The Department shall pay the ~~Board Members and deduct the Contractor's share from monies owed to the contractor. If monies owed are not sufficient, the Contractor shall pay the Department directly for its share of the fees and expenses.~~

Board Members and deduct the Contractor's share from the retainage. If retainage is not sufficient, the Contractor shall pay the Department directly for its share of the fees and expenses.

March 20, 2003

**THE SOUTH CAROLINA MINING ACT**

The South Carolina Mining Act enacted by the General Assembly in 1973 requires that the Department adopt reclamation standards to govern activities of the Department and any person acting under contract with the Department, on highway rights-of-way or material pits maintained solely in connection with the construction, repair and maintenance of the public road systems in South Carolina.

**STANDARD PLAN FOR THE RECLAMATION OF EXCAVATED AREAS ADOPTED BY  
THE SOUTH CAROLINA DEPARTMENT OF TRANSPORTATION**

Reclamation plans as stated herein shall include all areas disturbed in excavations of borrow and material pits, except planned inundated areas.

The final side slopes of areas excavated for borrow and material pits shall be left at such an angle so as to minimize erosion and the possibility of slides. The minimum slope in every case shall be not less than 3:1.

Small pools of water that are, or are likely to become noxious, odious, or foul should not be allowed to collect or remain on the borrow pit. Suitable drainage ditches, conduits, or surface gradient shall be constructed to avoid collection of noxious, odious, or foul pools of water unless the borrow pit is to be reclaimed into a lake or pond.

Borrow pits reclaimed to a lake or pond must have an adequate supply of water to maintain a water sufficient level to maintain a minimum water depth of four (4) feet on at least fifty (50) percent of the surface area of the lake or pond.

Excavated areas will be drained where feasible unless otherwise requested by the property owner where, in such instances, the property owner may wish to develop the excavated area for recreational purposes or for the raising of fish, or for other uses, in compliance with the South Carolina Mining Act.

Where material is stripped from the ground surface in relatively thin layers, the area, after excavation has been completed, will be thoroughly scarified and terraced and planted to establish satisfactory vegetation necessary to control erosion. Vegetative cover should be established on a continuing basis to ensure soil stability appropriate to the area. Conservation practices essential for controlling both on-site and off-site erosion and siltation must be established. A minimum of seventy-five (75) percent vegetative ground cover, with no substantial bare spots, must be established and maintained into the second growing season.

Excavated areas that are drained will be seeded to obtain a satisfactory vegetative cover. The side slopes of excavated area will be planted to vegetation.

The State Highway Engineer, or his duly appointed representative, will make a final inspection of the reclaimed area and keep a permanent record of his approval thereof. A map or sketch providing the location and approximate acreage of each pit used on the project will be made available to the Final Plans Engineer.

All applicable regulations of agencies and statutes relating to the prevention and abatement of pollution shall be complied with by the contractor in the performance of the contract.

\*\*\*\*\*

The Contractor shall comply with the provisions of the Plan which are applicable to the project as determined by the Engineer. Seeding or other work necessary to comply with the plan on pits furnished by the contractor shall be at the expense of the contractor. Bermuda shall not be planted on ground surface pit areas. The quantity of fescue seed specified in Subsection 810.04 of the Standard Specifications shall be increased by fifteen (15) pounds in lieu of the deleted bermuda seed.



November 4, 2013-March 4, 2007

**CRITICAL PATH METHOD CONSTRUCTION SCHEDULES**

**General**

This supplemental specification addresses schedule requirements for SCDOT contracts. There are three levels of schedules. The level required is included in the Special Provision. The level of schedule is selected based on the design field review completed in the preconstruction phase or during estimate development.

Level 1 – Minimal Schedule Requirement

Level 2 Schedule – Standard Critical Path Method Schedule

Level 3 Schedule – Critical Path Method Schedule with Monthly Cumulative Payment Clause.

**Level 1 Requirement:**

Provide to the Resident Construction Engineer (RCE) a four-week look-ahead schedule identifying planned weekly work activities. Update the schedule every two weeks. The look-ahead schedule allows the RCE to schedule construction engineering and inspection personnel. The Department will not be responsible for delays which may be caused by the contractor's failure to abide by his schedule. Failure to submit the look-ahead schedule as specified may result in the withholding of partial payment estimates.

Provide the look-ahead schedule in Word or Excel format or as directed by the RCE.

The Contractor may provide a CPM schedule as indicated in **Level 2 Schedule Requirements** in lieu of the four-week look-ahead schedule as follows:

- Notify, in writing, the RCE that a CPM schedule will be provided in lieu of a four-week look-ahead schedule. Provide timely notification so that the baseline schedule is submitted in accordance with **Level 2 Schedule Requirements - Submission, Review, and Acceptance Process – Baseline Schedule.**
- No payment will be made if the Contractor elects to provide a CPM as a Level I Requirement. **Measurement and Basis of Payment** will be according to the Level I Schedule.
- Election to provide a CPM schedule in lieu of a four-week look-ahead schedule will be for the duration of the project.

**Level 2 Schedule Requirements:**

For projects requiring a CPM schedule, the Contractor will provide and update a construction schedule to the SCDOT, which will be used as a quantitative basis for:

- Monitoring and evaluating the Contractor's progress in completing contracted work;
- Evaluating requests for additional contract time;

EXHIBIT 6 - SUPPLEMENTAL SPECIFICATIONS AND FORMS

- Budgeting for construction partial payment estimates; and
- Managing SCDOT engineering and inspection personnel.

The Contractor’s construction schedule shall encompass the entire contract period, and be developed consistent with the contract milestones and the contract maintenance of traffic plan. Critical path activities shall be identified for the duration of the project. The schedule shall also include sufficient information *as outlined in this supplemental specification* to provide for monetary and quantitative tracking of the work by the SCDOT.

Include and reference in the schedule at the time of occurrence, all documentation and explanations supporting a time adjustment request.

**Utilities**

The schedule shall reflect the utility relocations noted in the contract documents and discovered during field review and include activities of appropriate duration, location, and logic, as provided by the Utility, for the utility work. Where utility durations are unknown, the Contractor shall provide a reasonable estimate of duration. Utility durations will be reviewed in the baseline approval process as outlined in the section “Submission, Review, and Acceptance Process.” Utility durations will be presented at the Preconstruction Conference for concurrence by the utility provider. In the event that the utility representative cannot provide concurrence at the Preconstruction Conference, the Contractor, the Resident Construction Engineer, and the utility provider shall work diligently to reach acceptable durations. If there is no concurrence or input from the utility provider concerning the Contractor’s utility durations within 15 calendar days following the Preconstruction Conference, the submission with the Contractor’s estimate of utility duration will be reviewed for baseline acceptance. Further utility duration changes beyond this point in time will be assessed in monthly schedule updates. Failure to include activities for any element of work or any known utility work will not relieve the Contractor from completing the work within the allotted contract time.

**Schedule Submissions**

Contractors shall maintain CPM schedules for all applicable projects using at a minimum Primavera Project Management 5.0 or Primavera Contractor 5.0. The Contractor shall coordinate with the Department’s District Scheduler to provide an exported schedule importable into the Primavera version used by the Department.

Templates for the CPM schedules are available to download at the SCDOT construction Extranet site located:

[http://www.scdot.org/doing/constructionLetting\\_Extranet.aspx](http://www.scdot.org/doing/constructionLetting_Extranet.aspx)

When submitting schedules to the SCDOT, the Contractor shall assign file names to each schedule file (baseline and updates) according to the following conventions (dates are YYMMDD):

Type of Schedule Submitted:	Baseline	Update	As-Built
File Name Convention:	[Contract ID]b[Data Date]	[Contract ID]u[Data Date]	[Contract ID]ab[Data Date]
File Name Example:	32.82571b060201	32.82571u060201	32.82571ab060201

## EXHIBIT 6 - SUPPLEMENTAL SPECIFICATIONS AND FORMS

**Note on Data Dates** - The initial Baseline Construction Schedule shall have a data date equal to the Award Date and not include any work to date. Monthly schedule updates shall have a data date set 1 day beyond the most recent estimate period end date.

Extranet file names upon uploading shall include the contract ID.

All submissions shall be made within the time frames defined under "Submission, Review and Acceptance Process."

**Electronic Files:** Upload each baseline construction schedule and monthly update submission to the SCDOT Construction Extranet site in .xer format.

The Extranet site location is:

[http://www.scdot.org/doing/constructionLetting\\_Extranet.aspx](http://www.scdot.org/doing/constructionLetting_Extranet.aspx)

Provide an Adobe file of each baseline construction schedule, monthly update submission, and schedule narrative to the District Scheduler and the Resident Construction Engineer. The schedule Adobe file shall include the following columns in 11 inch x 17 inch format: Activity ID, Activity Name, Start, Finish, Schedule % Complete, Physical % Complete, Budgeted Total Cost, Actual Total Cost, Remaining Total Cost, At Completion Total Cost, Original Duration, Remaining Duration, At Completion Duration, Earned Value, Planned Value, Schedule Variance Index, and Total Float. Sort on "Start" prior to printing to Adobe.

**Schedule Narrative:** Submit a Schedule Narrative Report with the baseline and each monthly update schedule describing current project schedule status and identifying potential delays. This report will include a description of the progress made since the previous schedule submission and objectives for the upcoming 30 calendar days.

- 1) Address all previous schedule review comments;
- 2) The report shall indicate if the project is *on schedule*, *ahead of schedule* or *behind schedule* as compared to the accepted baseline. Include the Schedule Variance Index, planned value cost and earned value cost. If the project is ahead of schedule or behind schedule, the report shall include the specific number of calendar days. If the project is behind schedule, the report shall include a detailed recovery plan that will put the project back on schedule. The narrative shall compare the Substantial Completion milestone for the baseline with the update;
- 3) Describe the *current critical path* of the project including the lowest total float value and indicate if this has changed in the last 30 calendar days. Discuss current successes or problems that have affected either the critical path's length or have caused a shift in the critical path within the last 30 calendar days. Identify specific activities, progress, or events that may reasonably be anticipated to impact the critical path within the next 30 calendar days, either to affect its length or to shift it to an alternate path;
- 4) List all schedule logic or duration changes that have been made to the schedule since the previous submission. Provide an explanation for any *constraint* used.

For each change, describe the basis for the change and specifically identify the affected activities by identification number;

- 5) Scheduling assumptions (considerations for known and foreseeable constraints or restrictions such as weather, traffic, environmental, utility, safety, etc);
- 6) Identify activities, either in progress or scheduled to occur within the following 30 calendar days that require Department participation, review, approval, etc;
- 7) Identify any calendars used that are not DOT specific, and explain the details of those calendars;
- 8) Identify schedule settings used;
- 9) Identify activity expense item changes;
- 10) Minimized the use of lag. Where possible, use an activity to represent lag time. In no instance shall negative lag be used;
- 11) Description of how the schedule is organized (e.g. broken down by road or activity);
- 12) Explain any actual duration exceeding the original duration;
- 13) Explain out of sequence activities individually and the overall effect on the schedule;
- 14) Explain, individually, activities that failed to start in the previous 30 days;
- 15) Include the current contract completion date;
- 16) Include the current contract amount and sum of actual cost;
- 17) Include approved change orders. Explain the costs and schedule change associated with them;
- 18) Submit the narrative with a naming convention of [Contract ID]n[Data Date].doc (e.g 32.82571n060201.doc). Contractor will upload the electronic copy [in .doc format] to the South Carolina Department of Transportation Construction Extranet site;
- 19) Explain the schedule impacts of all utility work, known or anticipated;

## **Schedule Details**

SCDOT reserves the user\_text1 and user\_text2 fields.

**Data Date** - The Baseline Construction Schedule shall have a data date equal to award date and not include any completed work to date. Monthly schedule updates shall have a data date set to one day beyond the most recent estimate period end date.

**Milestones** - Schedule shall identify the following milestones as a minimum:

- **Award Date:** The date the Contractor is notified by the Director of Construction that he is awarded the project.
- **Contract Execution Date:** The date the contract is signed by the Department.
- **Baseline CPM Acceptance:** Anticipated date the baseline schedule is accepted. No work will start prior to this milestone date.
- **Notice to Proceed Date (NTP):** the NTP date is determined in coordination between the Engineer and the Contractor.
- **Work Begin Date:** Actual date that on-site work commences. In the baseline CPM schedule, this is the anticipated work begin date by either the prime contractor or any subcontractor. Once work begins, status the schedule with the actual date recorded in SiteManager.
- **Interim Completion Dates or Interim Milestones:** When interim completion dates or interim milestones (associated with project stages) are included in the contract specifications.
- **Mobilization:** Preparations for and moving of equipment, etc., to the project site.
- **Start of Paving:** Date paving production and placement is to start. This includes any paving requiring a SCDOT certified inspector representing the Department.
- **Substantial Work Complete Date:** The point in the project when all pay items have been installed in reasonable conformance with the plans and specifications over the entire length of the project including tie-ins and all lanes of traffic are open to the public in their final configuration with the final applications of thermoplastic and raised pavement markers. The only remaining work to be performed is punch list items. Place a Finish On or Before constraint on this milestone equal to the completion date in the contract. If a change order is completed for time, update the constraint to the adjusted completion date.
- **As-Built CPM Schedule Submission:** The point in time in which the final schedule submission is made.
- **Project Liability Insurance Expiration Date MM/DD/YY:** This date references the expiration of the insurance as defined in Section 103.8 of the Standard Specification for Highway Construction. Include the date that the project liability insurance expires in the milestone activity name. If the expiration renewal date is prior to the Contract Completion Date, place a “Finish On” constraint on the finish milestone. If the expiration renewal date is beyond the Contract Completion Date, place an “As Late As Possible” constraint on the finish milestone. There are no logic ties for this milestone. Inclusion of this date in the CPM schedule does not relieve the contractor of his responsibility to retain liability insurance as defined by the Standard Specifications for Highway Construction.

Act  
ivit  
ies

—

## EXHIBIT 6 - SUPPLEMENTAL SPECIFICATIONS AND FORMS

- Each Activity shall be part of the logic driven network, be cost loaded using Expense Categories, and include a predecessor (except the first activity) and a successor (except the last activity).
- Each Activity Name shall include a verb and a noun and represent the work function.
- Activity Names shall include the location of the work when there are multiple activities of the same work in different locations of the project.
- Limit activity original duration to 30 calendar days.

As a minimum, and when applicable, the schedule shall include the following activities when related work is part of the contract.

- **Mobilization:** Provide the same number of mobilization activities as for payment in the proposal i.e.
  - **Mobilization Payment I**
  - **Mobilization Payment II**
- **Clearing & Grubbing:** Self-explanatory.
- **Utility Relocations:** The schedule must reflect the utility relocations noted in the contract documents and include activities of appropriate duration for the utility adjustments. Where utility durations are unknown, the Contractor shall provide a reasonable estimate of duration. Relate utility activities to the contract work activities that they effect or are affected by.
- **Cure Period:** The period of time between two activities needed for material curing. Examples include concrete and thermoplastic pavement markings. For this activity, use a seven day work week calendar.
- **Earthwork:** Unclassified & borrow excavation, compaction, fine grading, etc.
- **Drainage:** Pipe, catch basins, manholes, etc.
- **Base Course:** Graded aggregate base courses, cement modified bases, etc.
- **Paving:** Hot mix asphalt base, intermediate, and surface courses; Portland cement concrete pavements, etc.
- **Structures:** Bridges, box culverts, retaining walls, etc.

Where sufficient detail has not been provided in included activities to determine progress of work and forecast of inspection and cost, the Department will request additional activities be added. The Department requires retain logic be used in scheduling projects. Relationship ties of all out-of-sequence activities should be corrected to reflect the actual occurrence. The use of progress override is not permitted. The monthly schedule update narrative shall justify any logic change(s).

**Suspend Dates** - The use of suspended dates is prohibited. If the activity is disrupted, break out into additional activities and explain in narrative.

**Activity Expected Finish Dates** – Activity Expected Finish dates are prohibited.

**Resources** – The Department will not require any input to the resource component of the schedule by the Contractor.

**Expenses** – Contractor shall assign the SCDOT contract items as expenses to each activity. The information provided under Expenses is used to evaluate daily production rates. SCDOT contract items will be included as Expense Categories and will be made part of the SCDOT schedule template available to download from the construction Extranet site. These shall be the only expense categories associated with activities. Under expenses, populate the fields Budgeted Units, Price/Unit, and Actual Units. If a SCDOT contract item cannot be found in the most current template, SCDOT should be contacted. The template will then be updated and uploaded to the extranet by SCDOT.

**Weather** - Considerations for normal weather shall be addressed within the activity duration.

**Calendars** – Contractor shall assign an appropriate SCDOT calendar to each activity in the schedule. Alternate calendars may be assigned, but specifics of the alternate calendars must be justified in the baseline narrative. Contractor shall assign all calendars as project specific – NOT GLOBAL. Acceptance of the alternate calendars is subject to review by the SCDOT. Considerations for weather shall be addressed within the activities – calendars shall not be modified to account for weather considerations. While calendars have been created to address established seasonal restrictions, it is the Contractor’s responsibility to assure that all restrictions, as identified in the contract documents, are included. Where the Contractor elects to not utilize all available contract time in the baseline schedule submission, either by blocking out days in the calendar or including an activity for an extended period of no work, future delays against the time omitted will not warrant additional time.

The Baseline Construction Schedule shall not extend beyond the number of working days or contract completion date originally provided in the contract.

**Cost Loading** – All schedule activities shall be cost loaded using the contract bid items (Expense Categories), unit prices, and units (quantities) under “Expenses” in Primavera. Associated expenses shall correlate with the item of work covered by the activity.

**Float** – Float is not for the exclusive use or benefit of either the Department or the Contractor. Negative float in the original baseline schedule is not allowed.

**Schedule Layout** – Organize the schedule using a Work Breakdown Structure (WBS) consistent with the phasing and staging noted in the contract documents.

**Default Values** – Contractor shall use the following defaults, physical percent complete, retain logic, longest path critical activities, and under Admin Preferences, make Time Periods 8.0 hours/day, 40 hours/week, 172 hours/month, and 2,000 hours/year.

## Submission, Review and Acceptance Process

### Baseline Schedule –

#### Submission:

##### Regular Bid Projects:

Contractor shall submit a Critical Path Method (CPM) Contract Schedule and Narrative to the District Scheduler no more than 15 calendar days after execution of the contract or 15 days prior to the preconstruction conference, whichever is earlier. Once the initial baseline schedule is submitted, a preconstruction meeting date may be assigned by the RCE and Contractor. The CPM Schedule and Narrative shall be submitted via upload to the Extranet. Upon upload, the Contractor shall immediately notify the District Scheduler and the Resident Engineer via email that the CPM schedule has been submitted. The accepted CPM baseline schedule is paid for in the first available estimate period after contract execution.

##### A+B Bid Projects:

Contractor shall submit a Critical Path Method (CPM) Contract Schedule and Narrative to the District Scheduler no less than 15 calendar days prior to the preconstruction conference. Once the initial baseline schedule is submitted, a preconstruction meeting date can be assigned by the RCE and Contractor. The preconstruction meeting shall be assigned no earlier than 15 calendar days after the initial baseline submission. The CPM Schedule and Narrative shall be submitted via upload to the Extranet. Upon upload, the Contractor shall immediately notify the District Scheduler and the Resident Engineer via email that the CPM schedule has been submitted.

#### Review:

Upon receipt of the CPM Construction Schedule, SCDOT shall review and provide comments to the Contractor within 10 business days of receipt. The Contractor will have 5 business days to respond to SCDOT comments. This process will continue until the Engineer and the District Scheduler determines the construction schedule is acceptable.

The Contractor's representative familiar with the submitted schedule shall present and discuss their accepted schedule at the Preconstruction Conference. In the event the schedule has not been accepted (i.e. review process is ongoing), the most current schedule under review shall be presented.

#### Acceptance:

Acceptance of the submitted schedule by the SCDOT will establish the baseline schedule for the contract. This acceptance by SCDOT does not serve to excuse any omissions or errors in the Contractor's schedule (i.e. activities not included in baseline will not be considered in any time extensions).



Review and **acceptance of baseline schedule is required prior to start of work.** Delays in reaching this acceptance will not constitute a basis for granting additional contract time. If there is no concurrence or input from the utility provider concerning the Contractor's utility durations within 15 days following the Preconstruction Conference, the submission with the Contractor's estimate of utility duration will be reviewed for baseline acceptance. Further utility duration changes beyond this point in time will be assessed in monthly schedule updates.

### **Monthly Updates –**

Monthly updates shall be made no later than 15 calendar days following the most recent estimate period end date, whether or not an estimate was generated and shall have a data date one day beyond the most recent estimate period end date. If no work was completed during the estimate period, an update with the most current estimate period is required. Upon upload, the Contractor shall immediately notify the District Scheduler and the Resident Engineer via email that the CPM schedule has been submitted. Failure to submit timely updates will result in SCDOT evaluating contract status from the last submitted update schedule by adjusting the data date to the most current estimate period end date. Late update submittals may result in the Contractor being evaluated for preliminary delinquency in accordance with current version of the South Carolina Department of Transportation Standard Specifications for Highway Construction. Habitually late submittals may result in automatic delinquency. Failure to submit acceptable schedule updates as required will result in the withholding of the partial payment estimate regardless of preliminary delinquency. Updates shall include the following:

- Updated schedule to show actual progress on activities;
- Updated schedule to show actual costs on activities;
- Change orders that have occurred during the last estimate period;
- Any task dependent activity greater than 30 days in actual duration that has not incurred additional costs since the last update shall be terminated and broken into additional activities. Document the activity change and reason for late completion in the narrative;
- Remaining costs on completed activities are zeroed (if remaining costs are redistributed, indicate in the narrative the activities containing the costs);
- Update remaining cost appropriately;
- Updated schedule to show actual completion on milestones;
- Narrative to describe progress, planned activities, issues, adjustments to remedy any activities or milestones behind schedule, etc., in the format described in Schedule Submissions;
- Any changes other than those to actual start, actual finish, remaining duration, and Percent Complete are considered revisions. Revisions to a schedule update are subject to acceptance by the Engineer;

**As-Built Schedule** – A final As-Built Schedule shall be submitted within 15 calendar days following the contract completion. The as-built schedule should reflect the final project including extra work from change orders.

**Baseline Schedule Changes** – Once the baseline schedule has been accepted, all subsequent schedules provided will be considered schedule updates and compared to the original baseline. A new baseline will only be considered when significant changes in contract scope, changes in SCDOT priorities, or delays beyond the control of the Contractor occur.

If a baseline change is needed, the Contractor shall provide, in writing, a request to the Resident

Construction Engineer with the following information:

- An electronic copy of the proposed baseline schedule using the following naming convention and in accordance with **Schedule Types** (included previously)

Type of Schedule Submitted:	Updated Baseline
File Name Convention:	[Contract ID]ub[Data Date]
File Name Example:	32.82571ub060201

- Narrative identifying changes warranting a new baseline

A decision for an updated baseline will be made jointly between the Resident Engineer and the District Scheduler within 10 business days of receipt of request.

**Progress Meetings-** The contractor shall present the most current schedule at progress meetings to discuss any issues and upcoming events. If found necessary by the SCDOT, the contractor shall attend meetings to specifically discuss issues about the schedule.

**Level 3 Schedule Requirements**

Level 3 schedule requirements will be enforced on contracts where the bid amount exceeds \$20 million and one of the following occurs:

- SCDOT financial status warrants the specific control of large project monthly payouts
- The contract SVI is less than -0.50 or greater than 0.50 for two consecutive months indicating the project is significantly behind or ahead of the Contractor’s baseline schedule.

In the event that the Department chooses to enforce the Level 3 Schedule Requirement, the Contractor will submit an updated baseline schedule within 15 days of notification. The Contractor schedule will be used for payment purposes once the baseline schedule has been accepted by the Department. In addition to meeting the requirements of the Level 2 Schedule, the following shall apply.

**EXHIBIT 6 - SUPPLEMENTAL SPECIFICATIONS AND FORMS**

Once accepted by SCDOT, the project’s initial baseline cost loaded CPM will be used for SCDOT budget purposes and the contractor will not be paid in excess of the cumulative amount shown on the schedule through each payment date; regardless of what subsequent monthly updates indicate. For example, see chart below:

Pay period ending	12/31/11	1/31/12	2/29/12	3/31/12	4/30/12	5/31/12
Baseline CPM Planned Payout in Millions (Cumulative to Date)	2.0 (2.0)	3.0 (5.0)	3.0 (8.0)	4.0 (12.0)	4.0 (16.0)	3.0 (19.0)
Actual work performed (Cumulative to Date)	1.5 (1.5)	2.0 (3.5)	3.5 (7.0)	6.0 (13.0)	3.0 (16.0)	4.0 (20.0)
Payout by SCDOT (Cumulative to Date)	1.5 (1.5)	2.0 (3.5)	3.5 (7.0)	5.0 (12.0)	4.0 (16.0)	3.0 (19.0)

Partial payment estimates will be generated in SiteManager (computerized construction management system) based on actual quantities installed. If actual quantities installed exceed the cumulative schedule amount to date, a negative adjustment will be made in SiteManager to adjust the pay as necessary. For previous work exceeding the schedule amount, payments will be released as work progresses and payouts fall below the scheduled cumulative amount, never to exceed the cumulative scheduled amount through that pay period.

If significant contract changes are necessary, and upon approval by the SCDOT, a re-baseline to the initial CPM will be allowed per the CPM schedule specification and the payout schedule may be adjusted accordingly.

All subcontractors must be paid in accordance with the Prompt Payment Clause (Supplemental Specification dated June 14, 2000) for the quantities used to generate the partial payment estimates. In instances where a payout by SCDOT is less than the actual work installed under a given estimate, the Prompt Payment Clause is hereby amended to require full payment to all subcontractors, for work complete, within 7 days of receipt of said SCDOT payout.

**Contract Schedule Performance Evaluation:**

Project performance is not measured for contracts where the percent time < 0.30 for projects with a Level I Requirement and percent time < 0.20 for projects with the Level II Requirement or Level III Requirement.

$$\text{Percent Time} = (\text{Last Estimate Date} - \text{NTP}) / [(\text{Adj Completion Date}) - (\text{NTP})]$$

**Level I Requirement: Contracts with a minimal schedule requirement that are not deemed “on-call.”**

EXHIBIT 6 - SUPPLEMENTAL SPECIFICATIONS AND FORMS

Performance curves were developed using historical data from SiteManager based on contract type and ranges of contract amount. For each of these groupings, three curves identifying minimal performance levels are used to measure project performance. On the example below, the curves indicate that projects falling below the 50<sup>th</sup> percentile line are slower than 50 percent of the projects of same type and in the range of the bid amount indicated. Projects falling below the 40<sup>th</sup> percentile line are slower than 60 percent of the projects of the same type and in the range of the bid amount indicated. Projects falling below the 25<sup>th</sup> percentile line are slower than 75 percent of the projects of the same type and in the range of the bid amount indicated.

On a monthly basis at the end of the estimate period, a comparison of Time Percent Complete vs. Work Percent Complete will be made and plotted on a performance curve matching the contract type within the bid amount. The measurements are defined as:

Time Percent Complete = (Last Estimate Date – NTP)/[(Adj Completion

Date)-(NTP)] Work Percent Complete = Total Paid/(Total Bid + CO)

Poor Performance is considered when any contract is beyond its Adjusted Contract Completion date or when Time Percent Complete versus Work Percent Complete plots in the shaded area (on the appropriate performance curve) as defined by:

[30%, 75%) time below the 25<sup>th</sup> percentile line

-or-

[75%,100%] time below the 40<sup>th</sup> percentile line.

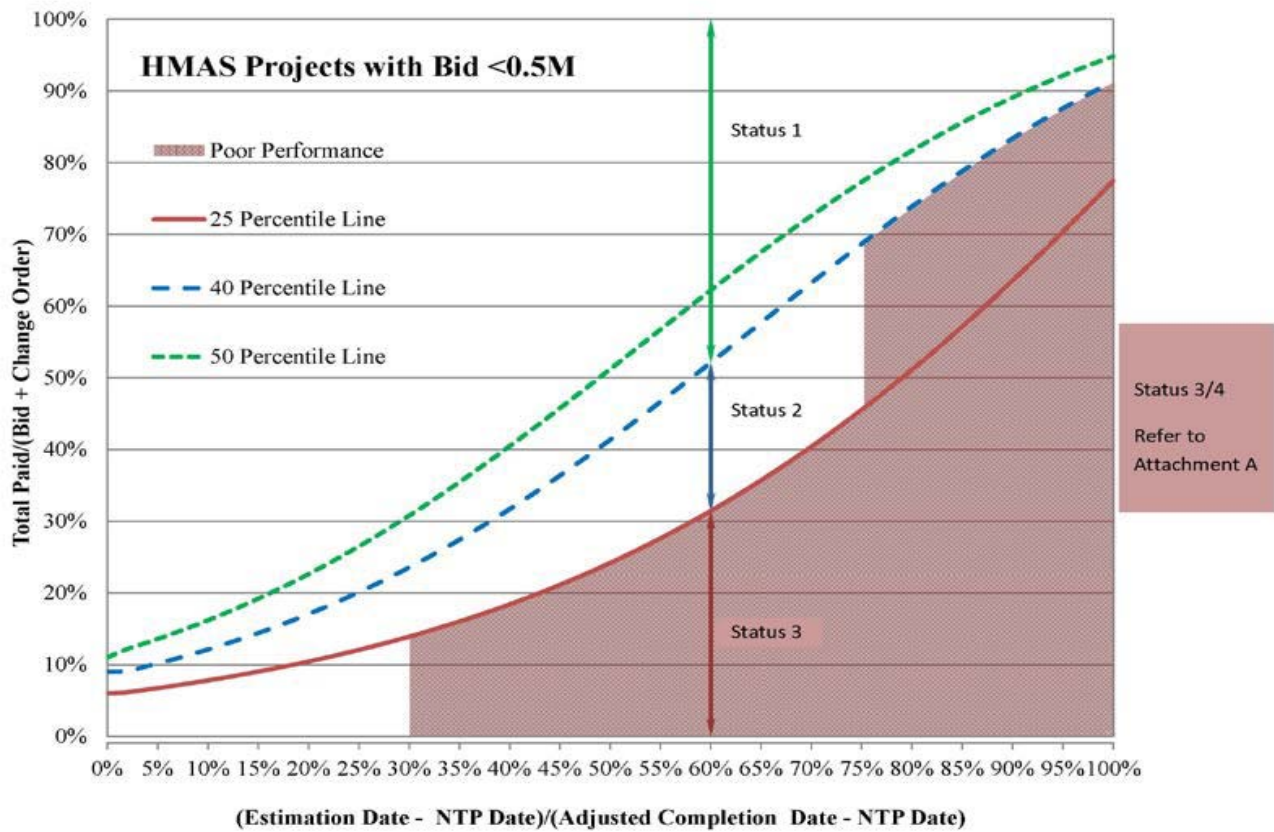

### Example Performance Curve

Performance curves may be found under Construction Schedule Templates on the Extranet at:

[http://www.scdot.org/doing/constructionLetting\\_Extranet.aspx](http://www.scdot.org/doing/constructionLetting_Extranet.aspx)

### Contracts with a CPM – Level II and III Schedule:

Monthly CPM updates are required for contracts with a CPM Level II or Level III schedule requirement as defined under **Submission, Review and Acceptance Process**. The contractor shall update actual completed quantities and physical percent complete (% of work complete for the activity) for all activities impacted during the most recent estimate period. Budgeted cost of the work performed (Earned Value) from the schedule update and budgeted cost of work planned (Planned Value) from the accepted baseline schedule are used to determine project variance in Primavera utilizing Schedule Variance Index (SVI). The calculation used by Primavera is:

$$\text{Schedule Variance Index (SVI)} = (\text{Earned Value} - \text{Planned Value}) / \text{Planned Value}$$

Where  $\text{SVI} < -0.10$ , the contract is considered to be slipping behind plan.

### Contract Performance Action:

EXHIBIT 6 - SUPPLEMENTAL SPECIFICATIONS AND FORMS

A summary of progress performance action is included below. Preliminary Notice of Delinquency is abbreviated as PND.

Type of Schedule	Ahead of Schedule	Status 1 Action	Status 2 Action	Status 3 Action	Status 3 Action	Status 3 Action	Status 4 Action
Level I Performance Curve	Projects falling above the 50% curve Monitor payouts	No Action	When plotting Time Percent Complete vs Work Percent Complete, if the contract falls in the shaded section of Status 2 or Status 3 on the appropriate performance curve,  <u>First Offense:</u> -PND w/o bonding notification -Request recovery  <u>Second Offense:</u> -PND w/bonding notice -Request recovery plan -Hold PND to monitor recover plan. If plan not met, move to delinquency.				If has not reached substantial completion and contract is beyond the contract completion > 45 days,  Notice of Default according to the Standard Specifications -Request plan to complete
Level II or III CPM	SVI > 0.10 Monitor payouts	SVI > -0.10 No Action	SVI (-0.10, -0.25] SVI (-0.25, -1.0]  Where SVI (-0.20, -1.0]  <u>First Offense:</u> -PND w/o bonding notification -Request recovery  <u>Second Offense:</u> -PND w/bonding notification -Request recovery plan -Hold PND to monitor recover plan. If plan not met, move to delinquency.			If the contract is beyond contract completion < 45 days  Preliminary Notice of Default w/bonding notice -Request plan to complete -Hold preliminary notice to monitor plan to complete. If plan not met, move to Default.	If contract is beyond the contract completion > 45 days,  Notice of Default according to the Standard Specifications -Request plan to complete

Notes: [ indicates inclusive of value  
( indicates exclusive of value

**Level I Schedules:**

When plotting Time Percent Complete vs Work Percent Complete as indicated above, if the contract falls in the shaded section on the appropriate performance curve,

**First Offense:**

- PND w/o bonding notification
- Request recovery plan

**Second Offense:**

- PND w/bonding notice
- Request recovery plan
- Hold PND to monitor recovery plan. If plan not met, move to delinquency

**Level II or III Schedules:**

In any estimate period where the SVI is (-0.20,-1.0] as defined under: **Contracts with a CPM**

**- Level II and III Schedule:**

**First Offense:**

- PND w/o bonding notification
- Request recovery plan

**Second Offense:**

- PND w/bonding notice
- Request recovery plan
- Hold PND to monitor recovery plan. If plan not met, move to delinquency

**Measurement and Basis of Payment**

**Level 1 Schedule**

There is no separate measurement or payment for look-ahead schedules. All costs associated with the preparation or revision of a look-ahead schedule are considered incidental to the work.

**Level 2 and 3 Schedules**

The Department will make partial payments according to Section 109, Standard Specifications for Highway Construction, and as modified by the following schedule:

Basis of Payment	Percentage of Contract Unit Price of Item
After the Engineer has accepted the CPM Baseline schedule	60
After the Engineer has accepted the As-Built CPM schedule	40

March 4, 2007

**General**

## EXHIBIT 6 - SUPPLEMENTAL SPECIFICATIONS AND FORMS

This supplemental specification addresses the Critical Path Method (CPM) construction schedule requirements for SCDOT contracts. The Contractor will provide and update a construction schedule to the SCDOT, which will be used as a quantitative basis for:

- Monitoring and evaluating the Contractor's progress in completing contracted work;
- Evaluating requests for additional contract time;
- Budgeting for construction estimate payments; and
- Managing SCDOT engineering and inspection personnel.

The Contractor's construction schedule shall encompass the entire contract period, and be developed consistent with the contract milestones and the contract maintenance of traffic plan. Critical path activities shall be identified for the duration of the work.

The schedule shall reflect the utility relocations noted in the contract documents and include activities of appropriate duration for the utility adjustments. Where utility durations are unknown, the Contractor shall provide a reasonable estimate of duration. Utility durations will be reviewed in the baseline approval process as outlined in the section "Submission, Review, and Acceptance Process." Utility durations will be presented at the Preconstruction Conference for concurrence by the utility provider. In the event that the utility representative cannot provide concurrence at the Preconstruction Conference, the Contractor, the Resident Construction Engineer, and the utility provider shall work diligently to reach acceptable durations. If there is no concurrence or input from the utility provider concerning the Contractor's utility durations within 15 days following the Preconstruction Conference, the submission with the Contractor's estimate of utility duration will be reviewed for baseline acceptance. Further utility duration changes beyond this point in time will be assessed in monthly schedule updates. Failure to include activities for any element of work or any known utility work will not relieve the Contractor from completing the work within the allotted contract time.

The schedule shall also include sufficient information as outlined in this supplemental specification to provide for monetary and quantitative tracking of the work by the SCDOT.

### **Schedule Types**

Contractors shall maintain CPM schedules for all projects using Primavera 5.0 (or current version) or Primavera Contractor.

Templates for the CPM schedules are available to download at the the SCDOT construction Extranet site ([http://www.scdot.org/doing/const\\_extranet.shtml](http://www.scdot.org/doing/const_extranet.shtml)).

When submitting schedules to the SCDOT, the Contractor shall assign file names to each schedule file (baseline and updates) according to the following conventions (dates are YYMMDD):

Type of Schedule Submitted:	Baseline	Update
File Name Convention:	{File Number}b{Data Date}	{File Number}u{Data Date}
File Name Example:	32.82571b060204	32.82571u060204

**Note on Data Dates** - The initial Baseline Construction Schedule shall have a data date equal to the date of submission of the schedule and not include any work to date. Monthly schedule updates shall have a data date set the same as the most recent estimate period end date.

### **Schedule Submissions**

All submissions shall be made within the time frames defined under "Submission, Review and Acceptance Process."

**Electronic File:** Each baseline construction schedule and monthly update submission shall be uploaded to the SCDOT Construction Extranet site in .xer format. The site can be found at: ([http://www.scdot.org/doing/const\\_extranet.shtml](http://www.scdot.org/doing/const_extranet.shtml))



## EXHIBIT 6 - SUPPLEMENTAL SPECIFICATIONS AND FORMS

**Hard Copies:** A hard copy of each baseline construction schedule and monthly update submission shall be provided to the District Scheduler and the Resident Construction Engineer. Printout shall include the following columns on 11 inch x 17 inch paper: Activity ID, Activity Name, Early Start, Actual Start, Early Finish, Actual Finish, Schedule % Complete, Physical % Complete, Budgeted Total Cost, Actual Total Cost, Original Duration, Remaining Duration, and Total Float.

**Schedule Narrative:** Submit a Schedule Narrative Report with the baseline and each monthly update schedule describing current project schedule status and identifying potential delays. This report will include a description of the progress made since the previous schedule submission and objectives for the upcoming 30 calendar days.

- 1) The report shall indicate if the project is *on schedule*, *ahead of schedule* or *behind schedule* as compared to the accepted baseline. If the project is ahead of schedule or behind schedule, the report shall include the specific number of calendar days. If the project is behind schedule, the report shall include a detailed recovery plan that will put the project back on schedule.
- 2) The report will describe the *current critical path* of the project including the lowest total float value and indicate if this has changed in the last 30 calendar days. Discuss current successes or problems that have affected either the critical path's length or have caused a shift in the critical path within the last 30 calendar days. Identify specific activities, progress, or events that may reasonably be anticipated to impact the critical path within the next 30 calendar days, either to affect its length or to shift it to an alternate path.
- 3) List all schedule logic or duration changes that have been made to the schedule since the previous submission. Provide an explanation for any *constraint* used. For each change, describe the basis for the change and specifically identify the affected activities by identification number.
- 4) Identify activities, either in progress or scheduled to occur within the following 30 days, that require Department participation, review, approval, etc.
- 5) Identify any calendars used that are not DOT specific, and explain the details of those calendars.
- 6) Identify schedule settings used.
- 7) An explanation of lag for each activity lag is associated with.
- 8) Description of how the schedule is organized (e.g. broken down by road or activity).
- 9) Narrative will be submitted with a naming convention of [File Number]n[Data Date].doc (e.g 32.82571n060201.doc). Contractor will upload the electronic copy [in .doc format] to the South Carolina Department of Transportation Construction Extranet site ([http://www.scdot.org/doing/const\\_extranet.shtml](http://www.scdot.org/doing/const_extranet.shtml)).

### Schedule Details

**Data Date** The Baseline Construction Schedule shall have a data date equal to the date of submission of the schedule and not include any completed work to date. Monthly schedule updates shall have a data date set the same as the most recent estimate period end date.

**Milestones** Schedule shall identify the following milestones as a minimum:

- **Notice to Proceed Date (NTP):** Issuance of this date indicates the project site is available to the Contractor and contract time has begun. The NTP is determined in coordination between the Engineer and the Contractor and shall be within 45 days of the Award Date unless extenuating

## EXHIBIT 6 - SUPPLEMENTAL SPECIFICATIONS AND FORMS

circumstances warrant setting the NTP more than 45 days after the Award Date. Include any extenuating circumstances in the narrative. The Notice to Proceed Date shall be the first milestone in the schedule.

- **Work Begin Date:** Actual date that on-site work commences.
- **Interim Completion Dates or Interim Milestones:** When interim completion dates or interim milestones (associated with project stages) are included in the contract specifications.
- **Start of Paving:** Date paving production and placement is to start.
- **Substantial Work Complete Date:** Anticipated date that work will be substantially complete. Facility will be available for the safe and convenient use of motorists; only allowable work remaining at substantial completion is placement of permanent pavement markings and resolution of punch list items.
- **Contract Completion Date:** Date defined by the Department as the latest date for contract completion. This is the last milestone and will establish the finish date of the project schedule. The schedule may indicate a completion date in advance of the contract completion date. However, the Department will not be liable for the Contractor's failure to complete the project prior to the Contract Completion Date. Any additional costs, including extended overhead incurred between the Contractor's schedule completion date and the completion of the contract time, shall be the responsibility of the Contractor.

**Activities** — Each Activity shall be part of the logic driven network and include a predecessor (excepting the first activity) and a successor (excepting the last activity). Each activity duration shall be limited to 30 days. As a minimum, the schedule shall include the following activities when related work is part of the contract, but there shall be sufficient detail in included activities to determine monthly progress of work and forecast of inspection and cost. The Contractor shall use the Activity Codes provided in the template for organizing activities. Activities for deliverables and reviews shall be included in the schedule.

- **Mobilization:** preparations for and moving of equipment, etc., to the project site.
- **Clearing & Grubbing:** Self explanatory.
- **Utility Relocations:** The schedule must reflect the utility relocations noted in the contract documents and include activities of appropriate duration for the utility adjustments. Where utility durations are unknown, the Contractor shall provide a reasonable estimate of duration.
- **Earthwork:** Unclassified & borrow excavation, compaction, fine grading, etc.
- **Drainage:** Pipe, catch basins, manholes, etc.
- **Base Course:** Graded aggregate base courses, cement modified bases, etc.
- **Paving:** Hot mix asphalt base, intermediate, and surface courses; Portland cement concrete pavements, etc.
- **Structures:** Bridges, box culverts, retaining walls, etc.

The Department requires retained logic be used in scheduling projects. In situations where a Contractor has to address activities out of sequence, the Contractor may request to use the "progress override" option. The monthly schedule update narrative shall provide justification for selecting this option and quantify any logic change(s).

**Resources** — The Department will not require any input to the resource component of the schedule by the Contractor.

**Expenses** — Contractor shall assign the SCDOT contract items as expenses to each activity. SCDOT contract items will be included as Expense Categories and will be made part of the SCDOT schedule template available to download from the construction Extranet site. These shall be the only expense categories associated with activities. Other fields under expenses that shall be populated include Budgeted Units, Price/Unit, and Actual Units.

**Calendars** — Contractor shall assign an appropriate SCDOT calendar to each activity in the schedule. Alternate calendars may be assigned, but specifics of the alternate calendars must be justified in the baseline narrative. Contractor shall assign all calendars as project specific. Acceptance of the alternate calendars is subject to review by the SCDOT. Considerations for weather shall be addressed within the

## EXHIBIT 6 - SUPPLEMENTAL SPECIFICATIONS AND FORMS

~~activities — calendars shall not be modified to account for weather considerations. Calendars have been created to address established seasonal restrictions.~~

~~The Baseline Construction Schedule shall not extend beyond the number of working days or contract completion date originally provided in the contract.~~

~~**Cost Loading** — All schedule activities shall be cost loaded using the contract items and unit prices under “Expenses” in Primavera.~~

~~**Float** — Float is not for the exclusive use or benefit of either the Department or the Contractor. Initial baseline schedules shall not attribute negative float or negative lag to any activity.~~

~~**Schedule Layout** — Schedule shall be structured consistent with the phasing and staging noted in the contract documents. Activity Codes for area and stage are included in the template. These codes shall be used to organize each activity included in “Schedule Details — Activities” as appropriate to provide a detailed schedule layout. Activities shall not be allowed to cover more than one stage of the contract.~~

~~**Default Values** — Contractor shall use the following defaults, physical percent complete, retain logic, and longest path critical activities.~~

### **Submission, Review and Acceptance Process**

~~**Baseline Schedule** — Contractor shall submit a Critical Path Method (CPM) Contract Schedule and Narrative to the District Scheduler within 30 calendar days after award of the Contract or 15 days prior to the preconstruction conference, whichever is earlier. The CPM Schedule and Narrative shall be submitted via upload to the Extranet. Upon upload, the Contractor shall immediately notify the District Scheduler and the Resident Engineer via email that the CPM schedule has been submitted.~~

~~Upon receipt of the CPM Construction Schedule, SCDOT shall review and provide comments to the Contractor within 10 days of receipt. The Contractor will have 5 business days to respond to SCDOT comments. This process will continue until the Engineer and the District Scheduler determine the construction schedule is acceptable.~~

~~The Contractor shall present their accepted schedule at the Preconstruction Conference. In the event the schedule has not been accepted (i.e. review process is ongoing), the most current schedule under review shall be presented.~~

~~Acceptance of the submitted schedule by the SCDOT will establish the baseline schedule for the contract. This acceptance by SCDOT does not serve to excuse any omissions or errors in the Contractor's schedule (i.e. activities not included in baseline will not be considered in any time extensions).~~

~~Review and acceptance of baseline schedule is required prior to start of work. Delays in reaching this acceptance will not constitute a basis for granting additional contract time. If there is no concurrence or input from the utility provider concerning the Contractor's utility durations within 15 days following the Preconstruction Conference, the submission with the Contractor's estimate of utility duration will be reviewed for baseline acceptance. Further utility duration changes beyond this point in time will be assessed in monthly schedule updates.~~

~~**Monthly Updates** — Monthly updates shall be made no later than 15 days following the most recent estimate and shall have a data date the same as the estimate period end date. Upon upload, the~~

**EXHIBIT 6 - SUPPLEMENTAL SPECIFICATIONS AND FORMS**

Contractor shall immediately notify the District Scheduler and the Resident Engineer via email that the CPM schedule has been submitted. Failure to submit acceptable schedule updates as required will result in the withholding of estimate payments. Updates shall include the following:

- Updated schedule to show actual progress on activities
- Updated schedule to show actual costs on activities
- Updated schedule to show actual completion on milestones
- Narrative to describe progress, planned activities, issues, adjustments to remedy any activities or milestones behind schedule, etc., in the format described in **Schedule Submissions**.

**As-Built Schedule** — A final As-Built Schedule shall be submitted within 45 days following substantial completion of the work or within 15 days following the contract completion, whichever is later.

**Baseline Schedule Changes** — Once the baseline schedule has been accepted, all subsequent schedules provided will be considered schedule updates and compared to the original baseline. A new baseline will only be considered when significant changes in contract scope, changes in SCDOT priorities, or delays beyond the control of the Contractor occur.

If a baseline change is needed, the Contractor shall provide, in writing, a request to the Resident Construction Engineer with the following information:

- An electronic copy of the proposed baseline schedule using the following naming convention and in accordance with **Schedule Types** (included previously)

Type of Schedule Submitted:	Updated Baseline
File Name Convention:	{File Number}ub{Data Date}
File Name Example:	32.82571ub060204

- Narrative identifying changes warranting a new baseline

A decision for an updated baseline will be made jointly between the Resident Engineer and the District Scheduler within 10 days of receipt of request.

**Measurement and Basis of Payment**

The Department will make partial payments according to Section 109, Standard Specifications for Highway Construction, and as modified by the following schedule:

Basis of Payment	Percentage of Contract Unit Price of Item
After the Engineer has approved the CPM Baseline schedule	60
After the Engineer has approved the As-Built CPM schedule	40

The Department will pay for the accepted quantities at the contract price as follows:

Item	Description
1080300	CPM Progress Schedule

January 5, 2012

**PROMPT PAYMENT CLAUSE**

- (1) Subject to the provisions on retainage provided in Paragraph (2) below, when a subcontractor has satisfactorily performed a work item of the subcontract, the Contractor must pay the subcontractor for the work item within seven (7) calendar days of the Contractor's receipt of payment from SCDOT. A subcontractor shall be considered to have "satisfactorily performed a work item of the subcontract" when the SCDOT pays the Contractor for that work item.
- (2) The Contractor may withhold as retainage up to five (5%) percent of a subcontractor's payment until satisfactory completion of all work items of the subcontract. "Satisfactory completion of all work items of the subcontract" shall mean when the SCDOT accepts the last work item of the subcontract. The Contractor must release to the subcontractor any retainage withheld within seven (7) calendar days from the date the Contractor receives payment from SCDOT for the last work item of the subcontract or within seven (7) days from SCDOT's acceptance of the last work item of the subcontract, whichever is the latest to occur. However, upon documentation of good cause provided by the contractor and written concurrence by the Director of Construction, the Contractor may continue to withhold the 5% retainage.
- (3) Prior to receiving payment of each monthly estimate, the Contractor shall certify to SCDOT that the construction estimate is complete and that all subcontractors have been paid for work covered by previous estimates, in accordance with sections 1 and 2.
- (4) Failure to comply with any of the above provisions shall result in one or more of the following sanctions: (1) no further payments to the Contractor unless and until compliance is achieved; (2) the Contractor being placed in default; and/or (3) the Contractor being declared delinquent, such delinquency being subject to procedures and penalties provided in 108.08 of the Standard Specifications.

April 1, 2008

**AS-BUILT CONSTRUCTION PLANS**

**GENERAL**

The Contractor shall produce and deliver to the Department the final As-Built plans for this contract. This set of As-Built plans is not intended to document final quantities, but is intended to show approved revisions to the contract design including but not limited to: revised roadway profiles and cross sections, revised typical sections, revised drainage installations, any changes to the demolition and removal items and any other changes to the original design.

If any design changes occur during construction, the plan sheets (or any other "job site record document" with a seal) revised after award of contract shall include a complete accounting and detail of the revisions and design changes. The P.E. responsible for the revisions shall seal each altered plan sheet (or any other "job site record document" with a seal). This documented information is to be part of the As-Built Plan requirements.

The As-Built plans shall be neat, legible and of the correct size. Bridge projects and any road projects which include Plan, Profile and Cross-Section Sheets shall be full size. In general, if the job was let with full size plans (22" X 36"), the As-Built shall be full size. All revisions to the original plans shall be delineated in red ink, located properly on the drawing, they shall be legible and true to scale. Every As-Built Plan, Profile and Cross-section Sheet shall be designated as such by note or stamp "As-Built" in red. The As-Built Plans shall be bound in the same manner as they were let, not combined. In other words, if a project includes road and bridge work and each is bound separately, keep them separate for As-Built, each with its own AB201 cover sheet.

In submitting As-Built Plans, the Contractor shall be required to complete FORM AB205 or AB206 whichever is applicable, and submit the form with the required deliverables to the RCE. The items and notes on these forms that apply to this project establish the minimum requirements for As-Built Plans. The forms can be found on the SCDOT website at <http://www.scdot.org/doing/default.html>.

The final As-Built plans shall be submitted within forty-five (45) days following the substantial work complete date of the project.

**MEASUREMENT**

Measurement is to be on a lump sum basis.

**PAYMENT**

Payment for this item is to be as follows:

50% of the contract amount is to be distributed over the duration of the project, and paid in amount proportional to the amount of contract work completed.

The remaining 50% of the contract amount is to be paid on the final estimate if As-Built plans meet the requirements to the satisfaction of the Resident Engineer.

In no case is payment to be in excess of the original bid amount for this item.

The Bid Item for this work is as follows:

<u>Item Number</u>	<u>Item</u>	<u>Unit</u>
1090200	As-Built Construction Plans	LS

July 1, 2010

**TRANSPORTATION AND DELIVERY OF MIXES**

**Subsection 401.4.17, Transportation and Delivery of Mixes, of the Standard Specification will be deleted in its entirety and replaced with the following:**

Transport the HMA from the plant to the point of use in vehicles meeting the requirements of Subsection 401.3.7. Do not permit any load of HMA to leave the plant so late in the day that it cannot be spread, finished, and compacted during daylight of that same day unless an approved artificial lighting system is provided. Ensure that HMA mixtures containing the asphalt binder grades below are produced and delivered to the jobsite within the acceptance range listed in the table below with exception that Base C and D mixtures will be produced and delivered at a temperature range of 240°-275° F. The mix temperatures will be checked using SC-T-84. Ensure the HMA mixtures are held within the acceptance range based on Binder Performance Grade in the Job Mix Formula. Deliver mixture within the acceptance range for temperature to assist in obtaining density requirements which provide smooth riding pavements with uniform texture.

<b>Binder Performance Grade</b>	<b>Acceptance Range (°F)</b>
PG 64-22	265°-325°
PG 70-22	285°-335°
PG 76-22	300°-350°

Note: This temperature specification does not apply to WMA (SC-M-408). Refer to the HMA Contractor's QC Plan for mix acceptance range based on selected asphalt plant WMA technologies.

July 2, 2009

**HIGH PRESSURE WATER METHOD  
For  
REMOVAL OF PAVEMENT MARKINGS**

**1. Description. -**

This item consists of removal of pavement markings from an asphalt or concrete pavement course by utilization of high pressure water. Eradicate and remove existing and temporary pavement markings, including waterborne fast dry paint, thermoplastic, and epoxy pavement markings, from the pavement surface by high pressure water where directed by the plans, the special provisions, the standard specifications, the MUTCD, and the Engineer.

**2. Requirements. -**

The Contractor shall conduct the removal operations of the pavement markings without damaging the surface or texture of the pavement course.

The Contractor shall remove no less than 95 percent of the total area of the pavement markings designated for removal to provide uniform exposure of the pavement surface. The presence of remnant pavement markings that indicate or may be perceived as a line shall require the Contractor to repeat the removal process.

The area of removal shall extend beyond all edges of the pavement marking designated for removal no less than ½ inch.

The Contractor shall remove all recoverable residue from the water blast cleaning method, including the water. When operating within 10 feet of a travel lane open to traffic or in an area that the residue may encroach onto the adjacent travel lane, the Contractor shall remove the residue immediately after contact between the water and the pavement surface. The removal process shall require a vacuum attachment operating concurrently with the blast operation or by an alternate method as approved by the Engineer. The Contractor is responsible for maintaining safety as required by the Department and all federal, state, and local laws.

In areas where pavement joints are present, the Contractor shall provide adequate protection of the pavement joints to prevent damage, disfigurement, compaction, or recession of the pavement joint material. The Contractor shall obtain approval of the proposed methods for providing protection of the joint material from the Engineer prior to beginning the work.

Removal of pavement markings by high pressure water is prohibited when the ambient air temperature is 40 degrees Fahrenheit or less or anticipated to decrease to 40 degrees Fahrenheit or less within 2 hours.

**3. Method of Measurement. -**

The Department will pay for removal of the pavement markings designated for removal by high pressure water at the contract unit price bid.

Measure the pavement markings designated for removal in square feet of the actual pavement markings to be removed. Determine the length of the pavement marking by measuring along the center of the line by the linear foot, excluding the spaces between broken lines, and multiplying by the width of the pavement marking in place. The measurement shall include the area of the marking only and shall



**EXHIBIT 6 - SUPPLEMENTAL SPECIFICATIONS AND FORMS**

exclude the area that extends ½” beyond the edges of each pavement marking designated for removal. The area ½” beyond the edges of each pavement marking shall be considered incidental.

Measure the removal of arrows, words, and railroad crossing symbols by the square footage of the full area occupied by the arrow, word, or railroad crossing symbol. To determine the square footage of arrows and words, measure the area as a complete square or rectangular area to encompass the complete arrow or word. The edges of the square or rectangular area designated for removal shall be parallel and perpendicular to the adjacent edge of pavement. A railroad crossing symbol consists of an “X” and two “R” ‘s. Determine the area of the railroad crossing symbol for removal, including only the area occupied by the “X” and two “R” ‘s, as a complete square or rectangle as designated above.

The Department will make no separate measurement for payment for traffic control during removal of pavement markings. Include all costs for traffic control in the contract lump sum price bid item for “Traffic Control”. In the absence of a bid item for “Traffic Control”, consider traffic control for application and removal of pavement markings incidental to the pavement marking bid items.

**4. Basis of Payment.**

The Department shall provide full compensation for providing all materials necessary to complete the job properly. Payment shall include the removal of the pavement markings, furnishing the materials, all labor, hardware, equipment, tools, incidentals, and any miscellaneous items necessary to complete the item of work.

Payment for each item includes all direct and indirect costs and expenses required to complete the work.

Payment will be made under:

<b>ITEM NO.</b>	<b>PAY ITEM</b>	<b>PAY UNIT</b>
<b>6091405</b>	<b>REMOVAL OF PAVEMENT MARKINGS (HIGH PRESSURE WATER)</b>	<b>SF</b>

September 1, 2012

TRAILER MOUNTED  
AUTOMATED FLAGGER ASSISTANCE DEVICE SYSTEM  
(AFAD)

**1. Description:**

This specification details the minimum requirements of all Automated Flagger Assistance Device Systems (AFAD) utilized and placed into operation on the roadways of the state of South Carolina.

An automated flagger assistance device system is a temporary traffic control device system for controlling the flow of traffic through temporary traffic control areas, typically work zones, that generate the requirement for two-way traffic to share a single travel lane. An automated flagger assistance device system shall consist of no less than 2 individual AFAD units linked and remotely controlled by wireless communications. A flagger(s), who has successfully completed a flagger training course sponsored by a South Carolina Department of Transportation approved work zone traffic control training provider, shall operate the system. Install, operate and maintain each AFAD unit as designated by these Supplemental Specifications, the manufacturer's specifications, the Standard Drawings for Road Construction, the Plans and the Engineer.

An automated flagger assistance device system acceptable for use on the roadways of the state of South Carolina shall be either a Type I "RED / YELLOW" Lens system or a Type II "STOP / SLOW" Sign system.

The automated flagger assistance device system shall comply with all requirements for Automated Flagger Assistance Devices as specified and directed by the MUTCD, latest edition, and this supplemental specification. An automated flagger assistance device system shall operate and comply with all requirements for flagging operations as specified and directed by the latest editions of the MUTCD, the South Carolina Flagger's Handbook and the Standard Specifications for Highway Construction. Also, an automated flagger assistance device system shall operate and comply with all requirements for flagging operations as specified and directed by the Standard Drawings for Road Construction, the special provisions, the plans and the Engineer.

**2. Operations Requirements:**

**A. General:** Automated flagger assistance device systems are only permitted for use on two-lane two-way roadways where each single travel lane of opposing traffic is required to utilize and share one travel lane. An AFAD system is PROHIBITED for use on multilane roadways with reduced numbers of travel lanes. An AFAD is not a traffic control signal and shall not be used as a temporary traffic control signal or to control traffic at any location with more than 2 opposing single travel lanes seeking to share one travel lane.

**B. Documentation:** Provide documentation to the SCDOT to verify that each operator of an automated flagger assistance device system has successfully completed instruction in the operation of a system by the manufacturer of that system. Also, provide documentation to verify that each operator has successfully completed a flagger training course sponsored by a South Carolina Department of Transportation approved work zone traffic control training provider.

- 1. Work Conducted under Contract to SCDOT** - Provide documentation of proof of successful completion of training in the proper operation of the AFAD system by the manufacturer of the system and successful completion of training as a flagger by a South Carolina Department of Transportation approved work zone traffic control training provider to the Resident Engineer no less than 7 days prior to placing an automated flagger assistance device into operation.

EXHIBIT 6 - SUPPLEMENTAL SPECIFICATIONS AND FORMS

2. **Work Conducted under Encroachment Permit** - Provide documentation of proof of successful completion of training in the proper operation of the AFAD system by the manufacturer of the system and successful completion of training as a flagger by a South Carolina Department of Transportation approved work zone traffic control training provider along with submittal of the encroachment permit to the SCDOT.

**C. Operator:** The operator of the an automated flagger assistance device system shall be a recipient of and have successfully completed instruction in the operation of the system by the manufacturer of that system. The operator shall have successfully completed a flagger training course sponsored by a South Carolina Department of Transportation approved work zone traffic control training provider.

The South Carolina Department of Transportation only recognizes the following entities as acceptable providers of work zone traffic control training for organizations outside of the SCDOT who perform work activities within the highway rights-of-way in South Carolina under either contract to SCDOT or encroachment permit:

American Traffic Safety Services Association (ATSSA)  
Institute for Transportation Research and Education at North Carolina State University (ITRE)  
Carolinas Association of General Contractors (AGC)  
National Safety Council South Carolina Chapter

The operator shall control the automated flagger assistance device system from a location with an unobstructed view of the AFAD unit as well as an unobstructed view of the approaching traffic. If a single operator is controlling more than one unit, the operator shall have an unobstructed view of traffic from both directions. At no time is the operator permitted to leave the AFAD unattended when the AFAD is operating.

**D. Site Location:** When sufficient shoulder space is available, place and position the AFAD unit on the shoulder of the roadway no closer than 1 foot from either the near edge line or the near edge of pavement when an edge line is absent to the near edge of the trailer when the gate arm is in the upright position. When sufficient shoulder space to attain the minimum 1 foot requirement is unavailable, minimal encroachment of the unit upon the adjacent travel lane is permitted.

Place and position the AFAD unit to allow the end of the gate arm, when in the down position, to reach the center of the adjacent travel lane being controlled by the unit. Encroachment by the gate arm when in the down position to a point less than to the center of the adjacent travel lane or into the opposing travel lane beyond the center of the roadway is PROHIBITED.

Install the advance warning signs required for typical flagging operations on each approach. In addition to the typical flagging operations sign array, also include and install a "Be Prepared To Stop" sign (W3-4-48) between the "Flagger" symbol sign (W20-7-48) and the AFAD unit on each approach. Therefore, the required advance warning signs for each approach are, "Be Prepared To Stop" (W3-4-48), "Flagger" symbol (W20-7-48), "One Lane Road Ahead" (W20-4-48-A) and "Road Work Ahead" (W20-1-48-A).

**E. Nighttime AFAD Flagging Operations:** During nighttime operations, illuminate each AFAD unit station with any combination of portable lights, standard electric lights, existing street lights, etc., that will provide a minimum illumination level of 108 Lx or 10 fc.

During nighttime operations, operators shall wear a safety vest and safety pants that comply with the requirements of ANSI / ISEA 107 standard performance for Class 3 risk exposure, latest revision, and a fluorescent hard hat. The safety vest and the safety pants shall be retroreflectorized and the color of the background material of the safety vest and safety pants shall be fluorescent orange-red or fluorescent yellow-green.

Supplement the array of advance warning signs with a changeable message sign for each approach during nighttime AFAD flagging operations. These changeable message signs are not required

during daytime operations. Install the changeable message signs 500' in advance of the advance warning sign arrays. Messages should be "Flagger Ahead" and "Prepare To Stop".

**3. System Requirements:**

**A. General:** An automated flagger assistance device system shall consist of a Main AFAD unit and a Remote AFAD unit, linked and remotely controlled by wireless communications. The individual trailer-mounted units shall have nesting capabilities to permit towing of both units in a single trailer configuration. When nested, all lights including stop, tail and turn signal lights of both units shall operate uniformly.

**B. Power Source:** The electrical power for operation of the sign shall be supplied by a 12 VDC power source or a 110 VAC or a 120 VAC power source. Provide and mount a D/C power source for the unit on the trailer. An adaptable 110 VAC or 120 VAC power source may be used when available and selected for use.

1. **D/C Powered:** Power the unit by means of a battery bank charged by photovoltaic solar panels and/or a built-in 110 VAC 10 amp battery charger. House the battery bank in a lockable heavy duty weatherproof box or cabinet. The battery bank shall have the capability to provide sufficient operating power to the unit for no less than 7 continuous days.
2. **A/C Powered:** Power the unit by means of a 110 VAC or 120 VAC power source. Equip the unit with ground fault circuit interrupter circuit breakers. Conduct all A/C power adaptations with UL approved equipment and methods.

**C. Remote Control:** Equip each AFAD unit with a controller capable of receiving and implementing instructions through wireless communications from a handheld transceiver. Also, equip each AFAD unit with a handheld transceiver that provides wireless communication with the unit controller to permit operation of the individual unit or the system by an operator or operators from remote locations. The system shall provide the capability for total system operation and control of both units by one operator from a primary handheld transceiver as well as allow independent unit operation by one operator per unit from unit specific handheld transceivers.

Monitor and verify data transmissions utilized to control the AFAD units. Digitally encode signal transmissions to minimize interference. Comply with all applicable requirements of the Federal Communications Commission. In the event communications are disrupted or lost, the system shall go into a "fail safe" mode and display the "Circular Red" / "STOP" indications and lower the gate arms.

**D. Gate Arm:** Equip each AFAD unit with an automated gate arm that descends to a down position across the travel lane that approaching traffic is operating in when the AFAD unit displays the condition for approaching traffic to stop. The automated gate arm shall ascend to an upright position when the AFAD unit displays the condition to allow stopped traffic to proceed past the location of the AFAD unit.

Acceptable operation of the gate arm shall require the gate arm to begin descent to the down position no less than 2 seconds or more than 4 seconds after the AFAD unit displays the condition for approaching traffic to stop. The gate arm shall begin ascent to the upright position not less than 1 second or more than 2 seconds prior to display of the condition to allow stopped traffic to proceed.

The gate arm shall measure no less than 8 feet in length and shall have a minimum vertical height of 4 inches when placed in the down position. Reflectorize both sides of the gate arm with a Type III Microprismatic retroreflective sheeting with vertical alternating red and white stripes at 16 inch intervals.

The gate arm shall deflect in the event an errant vehicle drives through and strikes the gate arm and then return to a functional position after the errant vehicle clears the gate arm.

**E. Trailer:** Fabricate and equip each trailer with a single axle, springs, support assembly and four (4) leveling or stabilizer jacks. Properly equip the trailer to comply with South Carolina Law governing motor vehicles. The minimum requirement for lights and reflectors shall include turn signals, dual tail lights, and brake lights. Equip each trailer with Safety chains meeting SAE J-697 standards and paint each trailer with Federal Standard No. 595, Orange No. 12246.

Each trailer mounted AFAD unit shall have the capability to withstand winds up to 80 MPH without overturning when in the operating configuration or position.

**4. Type I “RED / YELLOW” Lens System:**

A Type I “RED / YELLOW” Lens AFAD system shall alternately display a steadily illuminated Circular RED lens and a flashing Circular YELLOW lens to control traffic without the need for a “human flagger” in the immediate vicinity of the AFAD unit. The steadily illuminated Circular RED lens shall illuminate when approaching traffic is required to stop and the flashing Circular YELLOW lens shall illuminate when stopped or approaching traffic is permitted to proceed pass the location of the AFAD unit.

A RED / YELLOW Lens AFAD unit shall have no less than one set of Circular RED and Circular YELLOW lenses in a vertical configuration that have diameters of no less than 12 inches. Arrange the lenses to place the Circular RED above the Circular YELLOW and provide a minimum height of no less than 7 feet from the bottom of the apparatus housing the Circular YELLOW lens to the grade elevation of the travel lane under control of the AFAD unit. However, if the lenses are located over any portion of a travel lane in which traffic is operating and may pass underneath the lenses, the minimum mounting height shall be no less than 15 feet from the bottom of the apparatus housing the YELLOW lens to the grade elevation of the travel lane under control of the AFAD unit in which traffic is operating.

The gate arm shall begin its descent to the down position not less than 2 seconds or more than 4 seconds after the Circular RED lens is illuminated. The automated gate arm shall begin its ascent to the upright position not less than 1 second or more than 2 seconds prior to illumination of the flashing Circular YELLOW lens.

Install a “Stop Here On Red” sign (R10-6-36) or (R10-6a-30) on the right side of the approach at the point at which motorists are expected to stop when the Circular RED lens is illuminated.

**Transition Between RED and YELLOW Conditions -**

**Transition to Circular RED condition -** The flashing Circular YELLOW lens shall enter into a minimum 5 second steady illumination phase prior to transitioning to the steadily illuminated Circular RED condition. The gate arm shall begin its descent not less than 2 seconds or more than 4 seconds after the Circular RED lens is illuminated.

**Transition to Circular YELLOW condition -** The gate arm shall complete its ascent to the upright position not less than 1 second or more than 2 seconds prior to illumination of the flashing Circular YELLOW lens. The steadily illuminated Circular RED lens shall transition to the flashing Circular YELLOW lens.

The Type I “RED / YELLOW” Lens AFAD system shall include a fail-safe system with a conflict monitor or similar device to prevent display of conflicting indications between units. Also, the system shall provide indicators to notify the operators of power loss that may impede proper operation of the system.

**5. Type II “STOP / SLOW” Sign System:**

A Type II “STOP / SLOW” Sign AFAD system shall have a STOP / SLOW sign that alternately displays the STOP (R1-1-36) face and the SLOW (W20-8-36) face of a STOP / SLOW paddle to control traffic without the need for a “human flagger” in the immediate vicinity of the AFAD unit. The STOP sign face shall display when approaching traffic is required to stop and the SLOW sign face shall display when stopped or approaching traffic is permitted to proceed pass the location of the AFAD unit.

The STOP / SLOW sign, fabricated from a rigid material, shall have an octagonal shape with a minimum face size of 36 inches by 36 inches. Reflectorize each face of the sign with a Type VII, Type VIII or Type IX Prismatic Retroreflective sheeting included on the latest edition of the *SCDOT Qualified Products List 20*. The STOP sign face shall have a red background with white letters and border and the SLOW sign face shall have a diamond shaped orange background with black letters and border. The

letters shall have a minimum height of 8 inches. The sign faces shall have a minimum mounting height of 7 feet from the bottom of the sign to the grade elevation of the travel lane under control of the AFAD unit.

Supplement the Type II "STOP / SLOW" Sign AFAD unit with active conspicuity devices. Include a steadily illuminated RED lens beacon to illuminate when the STOP sign face is displayed and a flashing YELLOW lens beacon to illuminate when the SLOW sign face is displayed. Each beacon shall have a 12 inch signal lens. Mount the RED lens beacon no more than 24 inches above the top of the STOP sign face and YELLOW lens beacon no more than 24 inches above the top or to the side of the SLOW sign face.

Type B warning lights are PROHIBITED as alternatives to the 12 inch signal lens beacons.

The gate arm shall begin its descent to the down position 2 seconds or more than 4 seconds after the transition to a complete display of the STOP sign face is accomplished and the illumination of the steadily illuminated RED lens beacon. The automated gate arm shall begin its ascent to the upright position not less than 1 second or more than 2 seconds prior to the initiation of the transition from the STOP sign face to the SLOW sign face.

Install a "Wait On Stop" sign (R1-7-30) and a "Go On Slow" sign (R1-8-30) either on the same support structure as the AFAD unit or immediately adjacent to the AFAD unit.

**Transition Between STOP and SLOW Conditions -**

**Transition to STOP condition** - The RED lens beacon shall enter into a "flashing mode" no less than 5 seconds prior to transitioning from the SLOW sign face to the STOP sign face. Immediately upon completion of the transition to complete display of the STOP sign face, the "flashing mode" of the RED lens beacon shall transition to a steadily illuminated condition. The gate arm shall begin its descent in not less than 2 seconds or more than 4 seconds after completion of the transition to a complete display of the STOP sign face and illumination of the steadily illuminated RED lens beacon.

**Transition to SLOW condition** - The STOP sign face shall begin the transition to the SLOW sign face. The gate arm shall begin its ascent to the upright position not less than 1 second prior to the initiation of the transition from the STOP sign face to the SLOW sign face. The RED lens beacon shall cease to illuminate and the flashing YELLOW lens beacon shall begin to illuminate immediately upon completion of the transition of the STOP sign face to the SLOW sign face and the ascent of the gate arm to its completed upright position.

The Type II "STOP / SLOW" Sign AFAD system shall include a fail-safe system with a conflict monitor or similar device to prevent display of conflicting indications between units. Also, the system shall provide indicators to notify the operators of power loss that may impede proper operation of the system.

**3. Method of Measurement:** Unless otherwise specified, Automated Flagger Assistance Device Systems (AFAD's) are not measured for separate payment but are included in the contract lump sum bid price item Traffic Control as specified in Subsections 107.12 and 601.5 of the *2007 Standard Specifications for Highway Construction*.

**4. Basis of Payment:** Unless otherwise specified, payment for an Automated Flagger Assistance Device System (AFAD) is included in the contract lump sum bid price item Traffic Control as specified in Subsections 107.12 and 601.5 of the *2007 Standard Specifications for Highway Construction*. The payment shall be full compensation for providing, installing, removing, and relocating as necessary, operating, and maintaining an Automated Flagger Assistance Device System (AFAD). Payment shall include furnishing all labor, hardware, equipment, tools, incidentals, and any miscellaneous items necessary for installing, operating, and maintaining the system.

January 03, 2013

**TRAFFIC CONTROL**

Delete Subsection 601.1.3 of the Standard Specifications in their entirety and replace them with the following:

**601.1.3 Restrictions**

1

Installation and maintenance of a lane closure is PROHIBITED when not actively engaged in work activities specific to the location of the lane closure unless otherwise specified and approved by the RCE. The length of the lane closure shall not exceed the length of roadway anticipated to be subjected to the proposed work activities within the work shift time frame or the maximum lane closure length specified within the contract unless otherwise specified and approved by the RCE. Also, a maximum lane closure length specified within a contract does not warrant installation of the specified lane closure length when the length of the lane closure necessary for conducting the work activity is less. The length and duration of each lane closure, within the contract specified parameters, shall require approval by the RCE prior to installation. The length and duration of each lane closure may be reduced by the RCE if the work zone impacts generated by a lane closure are deemed excessive or unnecessary.

2

When hourly lane closure prohibitions are specified, the presence of temporary signs, portable sign supports, traffic control devices, trailer mounted equipment, truck mounted equipment, vehicles and vehicles with trailers relative to the installation or removal of a closure and personnel are prohibited within the 15 to 30 foot clear zone based upon the roadway speed limit during the prohibitive hours specified.

3

The Department reserves the right to restrict the installation of lane closures, road closures, shoulder closures, pacing operations or any operations that will impact the efficient flow of traffic or hinder normal traffic operations on the roads of the South Carolina state highway system during peak travel hours, holidays, holiday weekends, extended holiday periods, weekends, special events or any time traffic volumes are high. Do not close travel lanes of high volume highways during peak traffic periods or at any time traffic volumes exceed the numerical values determined to be acceptable by the Department. Do not close lanes or roads with high volume commuter traffic in cities and urban areas during peak traffic periods. Waiver or modification of these restrictions or the established hourly lane closure prohibition hours shall require written approval from either the Deputy Secretary of Engineering, the District Engineering Administrator or the Director of Construction. When determined to request such a waiver or modification of these restrictions, submit the request to the RCE no less than 30 days prior to the day in question.

4

The Department prohibits lane closures on interstate highways and high volume multilane primary routes during holiday weekends, extended holiday periods or special events as defined below unless otherwise directed by the Department. The Department's holiday lane closure restrictions for holidays that are observed on a Monday will include the weekend and are considered a holiday weekend unless otherwise established by these specifications. The Department defines the typical Monday holiday weekend as from 6:00 am of the Friday before the weekend until 6:00 a.m. of the Tuesday after the holiday. Lane closures, road closures, shoulder closures, pacing operations or any operations that will impact the efficient flow of traffic or hinder normal traffic operations during these Monday holiday weekends as defined above are prohibited unless otherwise directed by the Department.

5

**EXHIBIT 6 - SUPPLEMENTAL SPECIFICATIONS AND FORMS**

Easter and Thanksgiving holidays are varied and extended holiday periods of a holiday weekend. Easter holidays are defined as from 12:00 noon of the Thursday before Easter until 6:00 p.m. of the Monday after Easter. Thanksgiving holidays are defined as from 12:00 noon of the Wednesday before Thanksgiving Day until 6:00 a.m. of the Monday after Thanksgiving Day. Lane closures, road closures, shoulder closures, pacing operations or any operations that will impact the efficient flow of traffic or hinder normal traffic operations during the Easter and Thanksgiving holidays as defined above are prohibited unless otherwise directed by the Department.

6

The 4<sup>th</sup> of July holiday is considered an extended holiday period. Considering the progressive nature of the calendar, this extended holiday period will vary from year to year depending the upon day of the week the holiday occurs. See the table below. Lane closures, road closures, shoulder closures, pacing operations or any operations that will impact the efficient flow of traffic or hinder normal traffic operations during the 4<sup>th</sup> of July holiday as defined below are prohibited unless otherwise directed by the Department.

<b>4<sup>th</sup> of JULY HOLIDAY</b>	
<b>DAY OF WEEK</b>	<b>DURATION</b>
<b>MONDAY</b>	6:00 AM FRIDAY, JULY 1 <sup>ST</sup> through 10:00 PM SUNDAY JULY 10 <sup>TH</sup>
<b>TUESDAY</b>	6:00 AM FRIDAY, JUNE 30 <sup>TH</sup> through 10:00 PM SUNDAY JULY 9 <sup>TH</sup>
<b>WEDNESDAY</b>	6:00 AM FRIDAY, JUNE 29 <sup>TH</sup> through 10:00 PM SUNDAY JULY 8 <sup>TH</sup>
<b>THURSDAY</b>	6:00 AM FRIDAY, JUNE 28 <sup>TH</sup> through 10:00 PM SUNDAY JULY 7 <sup>TH</sup>
<b>FRIDAY</b>	6:00 AM FRIDAY, JUNE 27 <sup>TH</sup> through 10:00 PM SUNDAY JULY 13 <sup>TH</sup>
<b>SATURDAY</b>	6:00 AM FRIDAY, JUNE 26 <sup>TH</sup> through 10:00 PM SUNDAY JULY 12 <sup>TH</sup>
<b>SUNDAY</b>	6:00 AM FRIDAY, JUNE 25 <sup>TH</sup> through 10:00 PM SUNDAY JULY 11 <sup>TH</sup>

7

The Christmas holidays are considered an extended holiday period. Considering the progressive nature of the calendar, this extended holiday period will vary from year to year depending the upon day of the week the holiday occurs. See the table below. Lane closures, road closures, shoulder closures, pacing operations or any operations that will impact the efficient flow of traffic or hinder normal traffic operations during the Christmas holidays as defined below are prohibited unless otherwise directed by the Department.

**CHRISTMAS  
HOLIDAYS**



**EXHIBIT 6 - SUPPLEMENTAL SPECIFICATIONS AND FORMS**

<b>DAY OF WEEK</b>	<b>DURATION</b>
<b>MONDAY</b>	6:00 AM FRIDAY, DECEMBER 22 <sup>ND</sup> through 10:00 PM WEDNESDAY JANUARY 3 <sup>RD</sup>
<b>TUESDAY</b>	6:00 AM FRIDAY, DECEMBER 21 <sup>ST</sup> through 10:00 PM THURSDAY JANUARY 3 <sup>RD</sup>
<b>WEDNESDAY</b>	6:00 AM FRIDAY, DECEMBER 20 <sup>TH</sup> through 10:00 PM FRIDAY JANUARY 3 <sup>RD</sup>
<b>THURSDAY</b>	6:00 AM TUESDAY, DECEMBER 23 <sup>RD</sup> through 10:00 PM SUNDAY JANUARY 4 <sup>TH</sup>
<b>FRIDAY</b>	6:00 AM WEDNESDAY, DECEMBER 23 <sup>RD</sup> through 10:00 PM SUNDAY JANUARY 3 <sup>RD</sup>
<b>SATURDAY</b>	6:00 AM THURSDAY, DECEMBER 23 <sup>RD</sup> through 10:00 PM MONDAY JANUARY 3 <sup>RD</sup>
<b>SUNDAY</b>	6:00 AM FRIDAY, DECEMBER 23 <sup>RD</sup> through 10:00 PM TUESDAY JANUARY 3 <sup>RD</sup>

8

Special events are events generating excessive traffic as determined by the Department. Lane closures, road closures, shoulder closures, pacing operations or any operation that would impact the efficient flow of traffic or hinder normal traffic operations during special events are prohibited unless otherwise directed by the Department.

9

Observe all time restrictions regarding lane closures, road closures, shoulder closures or pacing operations. The RCE may extend these time restrictions as traffic conditions warrant. The Department reserves the right to suspend a lane closure, road closure, shoulder closure, pacing operation or any operation if the RCE determines a delay or a resulting traffic backup is excessive. Observe and maintain all project specific time restrictions as specified by the Plans, the Specifications and the RCE. Install and remove lane closures, road closures, shoulder closures or pacing operations including all relative traffic control devices and signs, within the time restrictions. Coordinate work activities requiring lane closures, road closures, shoulder closures or pacing operations in accordance with all restrictions.

March 19, 2014

**DISTRICT FIVE LANE CLOSURE RESTRICTIONS**

Roads on the following lists are restricted from daytime lane reductions or closures. All work requiring lane reductions or closures will be performed at night or possibly on weekends. Specific work hours will

**EXHIBIT 6 - SUPPLEMENTAL SPECIFICATIONS AND FORMS**

be determined on a case-by-case basis. For all holiday restrictions, see the supplemental specification, "Holiday Restrictions", dated January 3, 2013. Unscheduled or emergency repairs requiring lane reductions or closures may be allowed at other times upon approval by the RCE. Questions concerning this requirement are to be directed to the District Traffic Engineer.

**DARLINGTON COUNTY**

<b>ROAD NUMBER</b>	<b>TERMINI FROM</b>	<b>TERMINI TO</b>	<b>HOURLY LANE CLOSURE PROHIBITIONS</b>
US 15 Business	US 15	US 15 in Hartsville	MON-FRI: 7AM - 9AM 4PM - 6PM SAT: ----- SUN: -----
US 52	Florence County Line	US 52 Business (Southern Intersection)	MON-FRI: 7AM - 9AM 4PM - 6PM SAT: ----- SUN: -----
US 52	US 52 Business (Southern Intersection)	US 401	MON-FRI: 7AM - 9AM 4PM - 6PM SAT: ----- SUN: -----
US 52 Business	US 52 (Southern Intersection)	SC 34	MON-FRI: 7AM - 9AM 4PM - 6PM SAT: ----- SUN: -----
SC 151	US 52	SC 151 Business	MON-FRI: 7AM - 9AM 4PM - 6PM SAT: ----- SUN: -----

**EXHIBIT 6 - SUPPLEMENTAL SPECIFICATIONS AND FORMS**

**DILLON COUNTY**

**Note 1** — The Department prohibits lane closures on designated routes from 7:00 am of the Thursday before Memorial Day until 6:00 pm of the Tuesday after Labor Day where seasonal restrictions are noted.

**Note 2** — The Department prohibits daytime lane closures on Friday, Saturday and Sunday on designated routes from 7:00 am of the Thursday before Memorial Day until 6:00 pm of the Tuesday after Labor Day where seasonal restrictions are noted.

<b>ROAD NUMBER</b>	<b>TERMINI FROM</b>	<b>TERMINI TO</b>	<b>HOURLY LANE CLOSURE PROHIBITIONS</b>
US 301	Northern Latta Town Limits	US 501	MON-FRI: 7AM - 9AM 4PM - 6PM SAT: ----- SUN: -----
US 301	SC 9 (Hadford Blvd)	Road S-588	MON-FRI: 7AM - 9AM 4PM - 6PM SAT: ----- SUN: -----
US 301 / SC-9	SC 34 (Main Street)	SC 9 (Radford Blvd)	Seasonal Lane Closure Restrictions — See Note 1  Lane Closure Restrictions From 6:00 PM of the Tuesday after Labor Day To 7:00 AM of the Thursday before Memorial Day  MON-FRI: 7AM - 9AM 4PM - 6PM SAT: ----- SUN: -----
SC-9	US 301 / US 501	I-95	Seasonal Lane Closure Restrictions — See Note 1  Lane Closure Restrictions From 6:00 PM of the Tuesday after Labor Day To 7:00 AM of the Thursday before Memorial Day  MON-FRI: 7AM - 9AM 4PM - 6PM SAT: ----- SUN: -----
SC 38	US 501	Marlboro County Line	Seasonal Lane Closure Restrictions — See Note 2  No Daytime Lane Closures on Friday, Saturday and Sunday from 7:00 am of the Thursday before Memorial Day until 6:00 pm of the Tuesday after Labor Day.  CONTACT DISTRICT OFFICE FOR SPECIFIC HOURLY LANE CLOSURE PROHIBITIONS

**EXHIBIT 6 - SUPPLEMENTAL SPECIFICATIONS AND FORMS**

**FLORENCE COUNTY**

**Note 1** — The Department prohibits lane closures on designated routes from 7:00 am of the Thursday before Memorial Day until 6:00 pm of the Tuesday after Labor Day where seasonal restrictions are noted.

<b>ROAD NUMBER</b>	<b>TERMINI FROM</b>	<b>TERMINI TO</b>	<b>HOURLY LANE CLOSURE PROHIBITIONS</b>
US-52	Darlington County Line	Road S-57 Road S-107	MON-FRI: 7AM - 7PM SAT: 7AM - 7PM SUN: 7AM - 7PM
US-52	Road S-57 Road S-107	Williamsburg County Line	MON-FRI: 7AM - 9AM 4PM - 6PM SAT: ----- SUN: -----
US-76	I-95	SC-327	MON-FRI: 7AM - 7PM SAT: ----- SUN: -----
US-76	SC-327	Marion County Line	<b>Seasonal Lane Closure Restrictions – See Note 1</b> <hr/> <b>Lane Closure Restrictions From 6:00 PM of the Tuesday after Labor Day To 7:00 AM of the Thursday before Memorial Day</b>  MON-FRI: 7AM - 9AM 4PM - 6PM SAT: ----- SUN: -----
SC-327	I-95	US-76	<b>Seasonal Lane Closure Restrictions – See Note 1</b> <hr/> <b>Lane Closure Restrictions From 6:00 PM of the Tuesday after Labor Day To 7:00 AM of the Thursday before Memorial Day</b>  MON-FRI: 7AM - 9AM 4PM - 6PM SAT: ----- SUN: -----
SC-51	US-76	US-52	MON-FRI: 7AM - 9AM 4PM - 6PM SAT: ----- SUN: -----
Road S-12 (Church Street)	US-52	SC-51	MON-FRI: 7AM - 9AM 4PM - 6PM SAT: ----- SUN: -----
Road S-29	US-52	US-76	MON-FRI: 7AM - 9AM 4PM - 6PM SAT: ----- SUN: -----

EXHIBIT 6 - SUPPLEMENTAL SPECIFICATIONS AND FORMS

Road S-31 (Evans Street)	US-52	US-76	MON-FRI: 7AM - 9AM 4PM - 6PM SAT: ----- SUN: -----
Road S-92 (Cheves Street)	US-52	US-76	MON-FRI: 7AM - 9AM 4PM - 6PM SAT: ----- SUN: -----
Road S-167 (Darlington Street)	US-52	Road S-29	MON-FRI: 7AM - 9AM 4PM - 6PM SAT: ----- SUN: -----

**EXHIBIT 6 - SUPPLEMENTAL SPECIFICATIONS AND FORMS**

**GEORGETOWN COUNTY**

**Note 1** — The Department prohibits lane closures on designated routes from 7:00 am of the Thursday before Memorial Day until 6:00 pm of the Tuesday after Labor Day where seasonal restrictions are noted.

<b>ROAD NUMBER</b>	<b>TERMINI FROM</b>	<b>TERMINI TO</b>	<b>HOURLY LANE CLOSURE PROHIBITIONS</b>
<b>US 17</b>	<b>Horry County Line</b>	<b>Road S-266</b>	<p><b>Seasonal Lane Closure Restrictions – See Note 1</b></p> <hr/> <p><b>Lane Closure Restrictions From 6:00 PM of the Tuesday after Labor Day To 7:00 AM of the Thursday before Memorial Day</b></p> <p><b>Northbound</b>                      MON-THU: 7AM – 6PM                      FRI: 7AM – 8PM                      SAT: 10AM – 7PM                      SUN: 12PM(Noon) – 5PM  <b>Southbound</b>                      MON-THU: 7AM – 6PM                      FRI: 7AM – 7PM                      SAT: 10AM – 7PM                      SUN: 10AM – 6PM</p>
<b>US 17</b>	<b>Road S-266</b>	<b>Road S-80</b>	<p>MON-FRI: 7AM – 9AM                      4PM – 6PM                      SAT: -----                      SUN: -----</p>
<b>US 17</b>	<b>Road S-80</b>	<b>Road S-42</b>	<p><b>Seasonal Lane Closure Restrictions – See Note 1</b></p> <hr/> <p><b>Lane Closure Restrictions From 6:00 PM of the Tuesday after Labor Day To 7:00 AM of the Thursday before Memorial Day</b></p> <p><b>Northbound</b>                      MON-THU: 7AM – 6PM                      FRI: 7AM – 8PM                      SAT: 10AM – 7PM                      SUN: 12PM(Noon) – 5PM  <b>Southbound</b>                      MON-THU: 7AM – 6PM                      FRI: 7AM – 7PM                      SAT: 10AM – 7PM                      SUN: 10AM – 6PM</p>
<b>US 524</b>	<b>US 17</b>	<b>Road S-20</b>	<p>MON-FRI: 7AM – 9AM                      4PM – 6PM                      SAT: -----                      SUN: -----</p>
<b>US 704</b>	<b>US 524</b>	<b>SC 51</b>	<p>MON-FRI: 7AM – 9AM                      4PM – 6PM                      SAT: -----                      SUN: -----</p>

**EXHIBIT 6 - SUPPLEMENTAL SPECIFICATIONS AND FORMS**

**HORRY COUNTY**

**Note 1** — The Department prohibits lane closures on designated routes from 7:00 am of the Thursday before Memorial Day until 6:00 pm of the Tuesday after Labor Day where seasonal restrictions are noted.

<b>ROAD NUMBER</b>	<b>TERMINI FROM</b>	<b>TERMINI TO</b>	<b>HOURLY LANE CLOSURE PROHIBITIONS</b>
<b>US 17</b>	<b>Horry County Line</b>	<b>US 17 Business</b>	<p><b>Seasonal Lane Closure Restrictions – See Note 1</b></p> <hr/> <p><b>Lane Closure Restrictions From 6:00 PM of the Tuesday after Labor Day To 7:00 AM of the Thursday before Memorial Day</b></p> <p><b>Northbound</b>            MON-THU: 7AM – 6PM            FRI: 7AM – 8PM            SAT: 10AM – 7PM            SUN: 12PM(Noon) – 5PM</p> <p><b>Southbound</b>            MON-THU: 7AM – 6PM            FRI: 7AM – 7PM            SAT: 10AM – 7PM            SUN: 10AM – 6PM</p>
<b>US 17</b>	<b>US 17 Business</b>	<b>US 504</b>	<p><b>Seasonal Lane Closure Restrictions – See Note 1</b></p> <hr/> <p><b>Lane Closure Restrictions From 6:00 PM of the Tuesday after Labor Day To 7:00 AM of the Thursday before Memorial Day</b></p> <p><b>Northbound</b>            MON-THU: 7AM – 9PM            FRI: 7AM – 10PM            SAT: 8AM – 9PM            SUN: 10AM – 8PM</p> <p><b>Southbound</b>            MON-THU: 7AM – 9PM            FRI: 7AM – 10PM            SAT: 8AM – 9PM            SUN: 10AM – 8PM</p>

**EXHIBIT 6 - SUPPLEMENTAL SPECIFICATIONS AND FORMS**

<b>US 17</b>	<b>US 504</b>	<b>SC 90</b>	<p><b>Seasonal Lane Closure Restrictions – See Note 1</b></p> <hr/> <p><b>Lane Closure Restrictions From 6:00 PM of the Tuesday after Labor Day To 7:00 AM of the Thursday before Memorial Day</b></p> <p><b>Northbound</b>  <del>MON-THU: 7AM – 7PM</del>  <del>FRI: 7AM – 8PM</del>  <del>SAT: 10AM – 8PM</del>  <del>SUN: 11AM – 7PM</del></p> <p><b>Southbound</b>  <del>MON-FRI: 8AM – 8PM</del>  <del>SAT: 10AM – 8PM</del>  <del>SUN: 11AM – 6PM</del></p>
<b>US 17</b>	<b>SC 90</b>	<b>North Carolina State Line</b>	<p><b>Seasonal Lane Closure Restrictions – See Note 1</b></p> <hr/> <p><b>Lane Closure Restrictions From 6:00 PM of the Tuesday after Labor Day To 7:00 AM of the Thursday before Memorial Day</b></p> <p><b>Northbound</b>  <del>MON-THU: 7AM – 8PM</del>  <del>FRI: 7AM – 10PM</del>  <del>SAT: 9AM – 10PM</del>  <del>SUN: 11AM – 7PM</del></p> <p><b>Southbound</b>  <del>MON-THU: 9AM – 8PM</del>  <del>FRI: 9AM – 9PM</del>  <del>SAT: 10AM – 9PM</del>  <del>SUN: 11AM – 6PM</del></p>
<b>US 378</b>	<b>US 504</b>	<b>End of 5 Lane Section in Conway</b>	<p><del>MON-FRI: 7AM – 9AM</del>  <del>4PM – 6PM</del>  <del>SAT: 7AM – 9AM</del>  <del>4PM – 6PM</del>  <del>SUN: 7AM – 9AM</del>  <del>4PM – 6PM</del></p>
<b>US 504</b>	<b>US 504 Business</b>	<b>SC 22 (Conway Bypass)</b>	<p><b>Northbound</b>  <del>MON-WED: 9AM – 6PM</del>  <del>THU: 8AM – 6PM</del>  <del>FRI: 7AM – 7PM</del>  <del>SAT: 6AM – 6PM</del>  <del>SUN: 7AM – 8PM</del></p> <p><b>Southbound</b>  <del>MON-WED: 11AM – 6PM</del>  <del>THU: 10AM – 7PM</del>  <del>FRI: 10AM – 11PM</del>  <del>SAT: 9AM – 8PM</del>  <del>SUN: 10AM – 7PM</del></p>



EXHIBIT 6 - SUPPLEMENTAL SPECIFICATIONS AND FORMS

<p>US 501</p>	<p>SC 22 (Conway Bypass)</p>	<p>US 378</p>	<p><b>Northbound</b>                  MON: 10AM - 6PM                  TUE: _____                  WED: 10AM - 6PM                  THU: 9AM - 6PM                  FRI: 8AM - 6PM                  SAT: 6AM - 5PM                  SUN: 8AM - 7PM</p> <p><b>Southbound</b>                  MON: 11AM - 5PM                  TUE: _____                  WED: 11AM - 5PM                  THU: 11AM - 6PM                  FRI: 10AM - 9PM                  SAT: 9AM - 7PM                  SUN: 11AM - 7PM</p>
<p>US 501</p>	<p>US 378</p>	<p>US 17 (Kings Highway)</p>	<p><b>Seasonal Lane Closure Restrictions – See Note 1</b></p> <hr/> <p><b>Lane Closure Restrictions From 6:00 PM of the Tuesday after Labor Day To 7:00 AM of the Thursday before Memorial Day</b></p> <p><b>Northbound</b>                  MON-THU: 7AM - 11PM                  FRI: 7AM - 12AM (Mid-Night)                  SAT: 6AM - 12AM (Mid-Night)                  SUN: 7AM - 10PM</p> <p><b>Southbound</b>                  MON-THU: 6AM - 9PM                  FRI: 6AM - 11PM                  SAT: 7AM - 10PM                  SUN: 8AM - 9PM</p>
<p>US 701</p>	<p>US 501</p>	<p>End of 5 Lane Section                  South of US 501 in                  Conway</p>	<p>MON-FRI: 7AM - 9AM                  4PM - 6PM                  SAT: 7AM - 9AM                  4PM - 6PM                  SUN: 7AM - 9AM                  4PM - 6PM</p>
<p>US 701</p>	<p>US 501 Business</p>	<p>SC 319</p>	<p>MON-FRI: 7AM - 9AM                  4PM - 6PM                  SAT: 7AM - 9AM                  4PM - 6PM                  SUN: 7AM - 9AM                  4PM - 6PM</p>

EXHIBIT 6 - SUPPLEMENTAL SPECIFICATIONS AND FORMS

<p>SC 22 (Conway Bypass)</p>	<p>US 504</p>	<p>US 704</p>	<p><b>Eastbound</b>                  MON-THU: -----                  FRI: -----                  SAT: 11AM - 5PM                  SUN: -----</p> <p><b>Southbound</b>                  MON-THU: -----                  FRI: -----                  SAT: 8AM - 12PM (Noon)                  SUN: -----</p>
<p>SC 22 (Conway Bypass)</p>	<p>US 704</p>	<p>SC 31 (Carolina Bays Parkway)</p>	<p><b>Eastbound</b>                  MON-FRI: -----                  SAT: 12PM (Noon) - 6PM                  SUN: -----</p> <p><b>Southbound</b>                  MON-FRI: -----                  SAT: 7AM - 1PM                  SUN: 10AM - 3PM</p>
<p>SC 22 (Conway Bypass)</p>	<p>SC 31 (Carolina Bays Parkway)</p>	<p>US 17</p>	<p><b>Seasonal Lane Closure Restrictions – See Note 1</b></p> <hr/> <p><b>Lane Closure Restrictions From 6:00 PM of the Tuesday after Labor Day To 7:00 AM of the Thursday before Memorial Day</b></p> <p><b>Eastbound</b>                  MON-THU: 7AM - 7PM                  FRI: 7AM - 8PM                  SAT: 9AM - 7PM                  SUN: 11AM - 6PM</p> <p><b>Westbound</b>                  MON-THU: 10AM - 7PM                  FRI: 7AM - 8PM                  SAT: 10AM - 7PM                  SUN: 11AM - 6PM</p>



**EXHIBIT 6 - SUPPLEMENTAL SPECIFICATIONS AND FORMS**

<p align="center"><b>SC-31</b> (Carolina Bays Bypass)</p>	<p align="center"><b>SC-22</b> (Conway Bypass)</p>	<p align="center"><b>SC-9</b></p>	<p><b>Seasonal Lane Closure Restrictions – See Note 1</b></p> <hr/> <p><b>Lane Closure Restrictions From 6:00 PM of the Tuesday after Labor Day To 7:00 AM of the Thursday before Memorial Day</b></p> <p><b>Northbound</b>          MON-THU: 2PM – 7PM          FRI: 1PM – 7PM          SAT: 2PM – 7PM          SUN: 3PM – 6PM</p> <p><b>Southbound</b>          MON-THU: 7AM – 6PM          FRI: 7AM – 7PM          SAT: 10AM – 6PM          SUN: -----</p>
<p align="center"><b>SC-544</b> (Dick Pond Road)</p>	<p align="center"><b>US-501</b></p>	<p align="center"><b>US-17</b> (South Kings Highway)</p>	<p><b>Seasonal Lane Closure Restrictions – See Note 1</b></p> <hr/> <p><b>Lane Closure Restrictions From 6:00 PM of the Tuesday after Labor Day To 7:00 AM of the Thursday before Memorial Day</b></p> <p><b>Eastbound</b>          MON-WED: 6AM – 6PM          THU: 6AM – 7PM          FRI: 6AM – 8PM          SAT: 9AM – 7PM          SUN: 12PM (Noon) – 5PM</p> <p><b>Westbound</b>          MON-FRI: 7AM – 7PM          SAT: 7AM – 6PM          SUN: 9AM – 6PM</p>
<p align="center"><b>Road S-1315</b> (Grissom Parkway)</p>	<p align="center"><b>SC-31</b></p>	<p align="center"><b>Harrellson Blvd</b></p>	<p><b>MON-FRI: 7AM – 9AM</b>  <b>4PM – 6PM</b>  <b>SAT: 7AM – 9AM</b>  <b>4PM – 6PM</b>  <b>SUN: 7AM – 9AM</b>  <b>4PM – 6PM</b></p>

**EXHIBIT 6 - SUPPLEMENTAL SPECIFICATIONS AND FORMS**

**MARION COUNTY**

**Note 1** — The Department prohibits lane closures on designated routes from 7:00 am of the Thursday before Memorial Day until 6:00 pm of the Tuesday after Labor Day where seasonal restrictions are noted.

<b>ROAD NUMBER</b>	<b>TERMINI FROM</b>	<b>TERMINI TO</b>	<b>HOURLY LANE CLOSURE PROHIBITIONS</b>
US 76	Florence County Line	SC 576	<p>Seasonal Lane Closure Restrictions — See Note 1</p> <hr/> <p>Lane Closure Restrictions From 6:00 PM of the Tuesday after Labor Day To 7:00 AM of the Thursday before Memorial Day</p> <p>MON-FRI: 7AM - 9AM 4PM - 6PM</p> <p>SAT: -----</p> <p>SUN: 10AM - 7PM</p>
US 76	SC 576	SC 917	<p>Seasonal Lane Closure Restrictions — See Note 1</p> <hr/> <p>Lane Closure Restrictions From 6:00 PM of the Tuesday after Labor Day To 7:00 AM of the Thursday before Memorial Day</p> <p>MON-FRI: 7AM - 9AM 4PM - 6PM</p> <p>SAT: -----</p> <p>SUN: 10AM - 7PM</p>
SC 576	US 76	US 504	<p>Seasonal Lane Closure Restrictions — See Note 1</p> <hr/> <p>Lane Closure Restrictions From 6:00 PM of the Tuesday after Labor Day To 7:00 AM of the Thursday before Memorial Day</p> <p>MON-FRI: 7AM - 9AM 4PM - 6PM</p> <p>SAT: -----</p> <p>SUN: 10AM - 7PM</p>

**EXHIBIT 6 - SUPPLEMENTAL SPECIFICATIONS AND FORMS**

**MARLBORO COUNTY**

**Note 1** — The Department prohibits lane closures on designated routes from 7:00 am of the Thursday before Memorial Day until 6:00 pm of the Tuesday after Labor Day where seasonal restrictions are noted.

**Note 2** — The Department prohibits daytime lane closures on Friday, Saturday and Sunday on designated routes from 7:00 am of the Thursday before Memorial Day until 6:00 pm of the Tuesday after Labor Day where seasonal restrictions are noted.

<b>ROAD NUMBER</b>	<b>TERMINI FROM</b>	<b>TERMINI TO</b>	<b>HOURLY LANE CLOSURE PROHIBITIONS</b>
US 15 / US 404	SC 9 (West Intersection)	SC 385	MON-FRI: 7AM – 9AM 4PM – 6PM SAT: ----- SUN: -----
SC 38	Dillon County	US 15	<b>Seasonal Lane Closure Restrictions – See Note 2</b> ----- ----- <b>No Daytime Lane Closures on Friday, Saturday and Sunday from 7:00 am of the Thursday before Memorial Day until 6:00 pm of the Tuesday after Labor Day.</b>  CONTACT DISTRICT OFFICE FOR SPECIFIC HOURLY LANE CLOSURE PROHIBITIONS

**WILLIAMSBURG COUNTY**

<b>ROAD NUMBER</b>	<b>TERMINI FROM</b>	<b>TERMINI TO</b>	<b>HOURLY LANE CLOSURE PROHIBITIONS</b>
US 52	SC 527	Read S-186	MON-FRI: 7AM – 9AM 4PM – 6PM SAT: ----- SUN: -----

September 1, 2008

## ADHESIVELY BONDED ANCHORS AND DOWELS

### 1.0 Adhesively Bonded Anchors and Dowels

#### 1.1 Scope

Furnish all required labor, equipment, and materials and perform all operations necessary for installing anchors and dowels in concrete using an adhesive bonding system in accordance with the details shown on the Plans and with the requirements of this Specification. Provide a material system specifically intended for use in structural applications for bonding anchors and dowels to hardened concrete. Limit applications to anchors and dowels installed in horizontal, vertical, and downwardly inclined positions. Do not use adhesive anchors in overhead or upwardly inclined installations. See Figure 1.1.

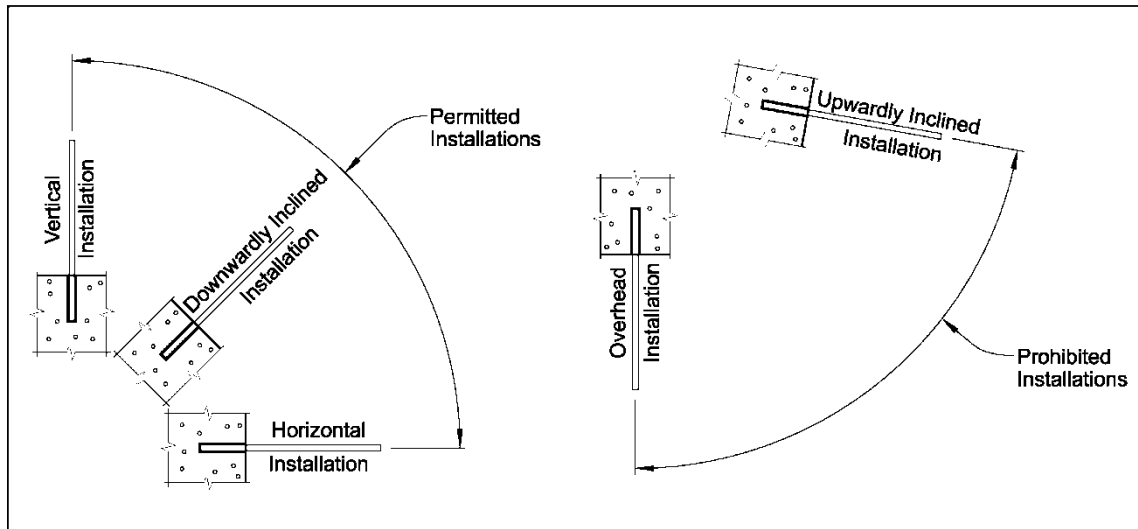

**Figure 1.1**

Submit a description of the proposed adhesive bonding system to the RCE for review, comments, and acceptance. Include in the description the anchor type, equipment, Manufacturer's recommended hole diameter, material specifications, and any other material, equipment or procedure not covered by the contract documents. List the properties of the adhesive, including density, minimum and maximum temperature application, setting time, shelf life, pot life, shear strength, bond strength, and compressive strength. If anchors or dowels containing a corrosion protective coating are required, provide an adhesive that does not contain any chemical elements that are detrimental to the coating and include a statement to this effect in the submittal concerning the contents as required by State or Federal Laws and Regulations.

Submit to the RCE Manufacturer's certification that the adhesive bonding system, when tested for tension pull-out according to ASTM E 488 utilizing identical anchorages, embedment depths, and concrete strengths as those specified on the Plans, does not fail by any mode listed in Section 12 of ASTM E 488 when loaded to the lesser of 85 percent of the specified bond strength (based on the nominal anchorage diameter and embedment depth) or 90 percent of the yield strength of the anchor. Also, submit to the RCE long term load (creep) test results performed in accordance with

ASTM E 1512, ICC–ES AC 58, or ICC–ES AC 308. When specified on the Plans, field testing will also be required for adhesive anchorages.

## **1.2 Materials**

Provide adhesive bonding material systems for structural applications that meet the requirements of ASTM C 881, Type IV, Grade 3, Class B or C (depending on site conditions). Do not use “Fast Set epoxy.” Package components of the adhesive in containers of such size that one whole container of each component is used in mixing one batch of adhesive. Use containers of such design that all of the contents may be readily removed, and are well sealed to prevent leakage. Do not use material from containers which are damaged or have been previously opened. Use only full packages of components. Furnish adhesive material that requires hand mixing in two separate containers designated as Component A and Component B or in a self-contained cartridge or capsule that consists of two components which will be automatically mixed as they are dispensed, as in the case of a cartridge, or drilled into, as in the case of a capsule.

Provide packages clearly marked by the Manufacturer with the following information:

- Manufacturer's name and address
- Product Name
- Date of Manufacture
- Expiration Date
- LOT Identification Number
- Storage and Handling Requirements

With each package include the Manufacturer's instructions for anchor and dowel installation. Include the following information with the instructions:

- Diameters of drilled holes for applicable anchor and dowel sizes.
- Cleaning procedure for drilled holes, including a description of permitted and prohibited equipment and techniques.
- Allowable temperature ranges for storage, installation and curing.
- Identification of acceptable mixing/dispensing nozzles.
- Fabrication requirements for anchors and dowels.
- Description of tools permitted or required for installation.
- Method of identifying properly proportioned and mixed adhesive materials.
- Time and temperature schedule for initial set ('gel time') and full-strength cure.
- Requirements for special installation conditions such as horizontal or near horizontal orientation of the anchor or dowel.

## **1.3 Construction Requirements**

### **1.3.1 Storage**

Deliver the adhesive bonding material system to the job-site in original unopened containers with the Manufacturer's label identifying the product. Store materials delivered to the job-site in the original unopened containers within an appropriate facility capable of maintaining storage conditions consistent with the Manufacturer's recommendations.

### **1.3.2 Installation**

Install the adhesive anchors and dowels perpendicular to the plane surface of the structural member, in accordance with Manufacturer's recommendations, and when the concrete is above 40 degrees Fahrenheit and has reached its 28 day strength. Install the anchorages before the adhesive's initial set ('gel time').

#### **1.3.2.1 Drilling of Holes into Concrete**



Ensure that concrete members receiving adhesive-bonded anchors or dowels are structurally sound and free of cracks in the vicinity of the anchor or dowel to be installed. When directed by the RCE, use a jig or fixture to ensure the holes are positioned and aligned correctly during the drilling process.

Use a metal detector specifically designed for locating steel in concrete to avoid conflicts with existing steel reinforcement whenever placement tolerances and edge clearances permit. Unless other equipment is recommended by the Manufacturer, drill holes to the diameter required by the Manufacturer using a rotary hammer drill and bit. Perform core drilling to clear existing steel reinforcement only when approved by the RCE. Dry the drilled holes completely prior to cleaning and installing the anchors or dowels. Clean and prepare drilled holes in accordance with the Manufacturer's recommendations, but as a minimum, use oil-free compressed air to remove loose particles from drilling, brush inside surface to free loose particles trapped in pores, then use compressed air again to remove the remaining loose particles. Use a non-metallic bristle brush and avoid over-brushing to prevent polishing the inside surface of the drilled hole. Check each hole with a depth gauge to ensure proper embedment depth. Repair spalled or otherwise damaged concrete using methods approved by the RCE.

#### **1.3.2.2 Inspection of Holes**

Inspect each hole immediately prior to placing the adhesive and the anchors/dowels. Ensure all holes are dry and free of dust, dirt, oil, and grease.

#### **1.3.2.3 Mixing of Adhesive**

Mix the adhesive in strict conformance with the Manufacturer's instructions.

#### **1.3.2.4 Embedment of Anchors and Dowels**

Remove all debris, oils, and any other deleterious material from the anchors and dowels to avoid contamination of the adhesive bonding material. Insert the anchor or dowel the specified depth into the hole and slightly agitate it to ensure wetting and complete encapsulation. After insertion of the anchor or dowel, strike off any excessive adhesive flush with the concrete face. Should the adhesive fail to fill the hole, add additional adhesive to the hole to allow a flush strike-off. Do not disturb the anchors and dowels while adhesive is hardening. For horizontal and inclined installations, provide temporary supports to maintain the alignment of the anchors or dowels until the adhesive bonding material has cured.

### **1.3.3 Field Testing**

When specified on the Plans, field test the installed anchors and dowels. Perform field testing of the installed anchors and dowels in accordance with the applicable sections of ASTM E 488. Inform the RCE and the Manufacturer when the tests will be performed at least 2 days prior to testing. For testing, use a calibrated hydraulic centerhole jack system that will not damage the anchor or dowel. Place the jack on a plate washer that has a hole at least 1/4" larger than the hole drilled into the concrete. Position the plate washer on center to allow an unobstructed pull. Position the anchors/dowels and the jack on the same axis. Have an approved testing agency calibrate the jack within 6 months prior to testing. Supply the RCE with a certificate of calibration.

Divide the anchors and dowels into LOTs for field testing and acceptance. A LOT consists of anchors or dowels of the same type, diameter, strength, embedment length, and adhesive bonding system. Prior to performing field tests, submit proposed testing locations to the RCE for review, comments, and acceptance. In the presence of the RCE, field test the anchors or dowels for each LOT in accordance with the following:

## EXHIBIT 6 - SUPPLEMENTAL SPECIFICATIONS AND FORMS

Test a minimum of 1 anchorage but not less than 10% of all anchors in the LOT to the test load shown on the Plans.

If less than 60 anchorages are to be installed: Install and test the minimum required number of anchorages prior to installing the remaining anchorages. After installing the remaining anchorages, test a minimum of 2 of these anchorages at random locations selected by the RCE.

If more than 60 anchorages are to be installed: Test the first 6 anchorages prior to installing the remaining anchorages. Then test, at random locations selected by the RCE, 10% of the number in excess of 60 anchorages.

For every failed field test, perform two additional field tests on adjacent untested anchors or dowels within the LOT. Continue additional field tests until no more test failures occur, or until all anchors and dowels within the LOT are tested.

Begin testing after the Manufacturer's recommended cure time has been reached. For testing, apply and hold the test load for three minutes. If the jack experiences any drop in gage reading, restart the test. For the anchorage to be deemed satisfactory, hold the test load for three minutes with no movement or drop in gage reading.

Remove all anchors and dowels that fail the field test, without damage to the surrounding concrete. Re-drill holes to remove adhesive bonding material residue and clean the hole in accordance with Subsection 1.3.2.1. For reinstalling replacement anchors or dowels, follow the same procedures as new installations. Do not reuse failed anchors or dowels unless approved by the RCE.

Determine failure of the field test in accordance with ASTM E 488. Submit certified test reports to the RCE. Final acceptance of the adhesively anchored system is based on the conformance of the pull test to the requirements of this Specification. Failure to meet the criteria of this Specification is grounds for rejection.

### **1.4 Measurement**

No separate measurement for payment will be made for furnishing, installing, and testing of adhesively bonded anchors and dowels.

### **1.5 Payment**

Include all costs of adhesively bonded anchors and dowels in the contract unit price bid for the items to be anchored.

April 5, 2010

### CONCRETE BATCHING AND MIXING

Delete subsection 701.4.4.1 Concrete Batching and Mixing – General, of the Standard Specifications in its entirety and replace it with the following:

#### 701.4.4 Concrete Batching and Mixing

##### 701.4.4.1 General

- 1 When concrete is furnished by a transit or central-mix plant, use batching equipment that is sufficient to weigh a load of the required size in less than 15 minutes.
- 2 Make certain that an SCDOT-certified concrete field technician is present at the plant when concrete is being produced for SCDOT work. The SCDOT-certified concrete field technician may be an employee of the Contractor, the concrete supplier, or an independent testing laboratory. While concrete is being produced for SCDOT work, ensure that the SCDOT-certified concrete field technician's sole, full-time responsibility is to maintain quality control records and conduct physical testing of concrete and its constituent materials.
- 3 Ensure that an SCDOT-certified concrete field technician completes and signs *Form 700.04* for the first load of each class of concrete delivered to the job site each day. After the completion of *Form 700.04* for the first delivered load, subsequent loads of each class of concrete will require *Form 700.04* or an OMR pre-approved batch ticket containing the appropriate information. A batch ticket may be pre-approved for use in SCDOT work through the Structural Materials Engineer if the batch ticket format contains at a minimum: date and time batched, load size, ticket number, aggregate moistures, amount of free water in aggregates, design target weights or measures for all materials, actual batch weights or measures for all materials, batched variances from targets listed as a percentage for all materials, designed water/cementitious materials ratio, batched water/cementitious materials ratios, designed batch water in gallons, actual batch water in gallons, and water in gallons held back from target value at the plant that can be added at the job site.
- 4 Except for Class 2500 concrete, prestressed concrete, and precast concrete, the Department will not accept concrete unless a completed *Form 700.04* or preapproved batch ticket that is signed and certified by the SCDOT-certified concrete technician, accompanies the delivery of the concrete. If a pre-approved batch ticket is being used and conditions warrant that the use of a batch ticket is unacceptable to the RCE, the SCDOT-certified concrete technician will discontinue using the batch ticket for acceptance and return to the use of *Form 700.04* until such time that the deficiencies of the batch ticket have been resolved and accepted by the RCE.
- 5 Provide sufficient advance notification to the [RCE](#) as to the name of the plant supplying the concrete in order to permit time to make the necessary arrangements for inspection of equipment at the plant.

April 1, 2013

**Concrete Structures –  
Preformed Joint Filler**

Delete Subsection 702.2.2.1 of the Standard Specifications in its entirety and replace it with the following:

**702.2.2.1 Preformed Joint Filler**

Use preformed joint material that meets AASHTO M 153 or AASHTO M 213 with the following exceptions:

1. Use only materials manufactured from rubber.
2. Use materials that require a load of not less than 340 kPa or greater than 5200 kPa to compress to 50% of its thickness when tested in accordance with AASHTO T 42.
3. Use materials that have a recovery of at least 70% when tested in accordance with AASHTO T 42.

Use preformed joint material that is listed on QPL 81.

Provide a manufacturer's certification that states that the material conforms to SCDOT specifications.

April 1, 2004.

**GEOTEXTILE FOR DRAINAGE FILTRATION**

I. ACCEPTANCE: The Contractor shall supply to the Resident Engineer, prior to placing the material, certified test results from a recognized laboratory of those tests specified herein. Acceptance will be based on the test results meeting these requirements<sup>1</sup> and the material meeting all stated specifications. The Resident Engineer shall submit the certified test results to the Research and Material Engineer for acceptance. Test data shall be no more than 1 year old at the time it is furnished to the Department. Once a fabric has been accepted, it will be listed on an Approval Sheet, and only those materials listed will be acceptable. Test data must be resubmitted for reapproval every 2 years. No fabric will be used nor will payment be made for fabric until the fabric certification is received and approved by the Research and Materials Engineer. The Department reserves the right to sample and test any of the fabrics, or other materials used in drainage filtration, at any time.

II. PIPING RESISTANCE: (soil retention - all applications)

A. Soils with 50% or less particles by weight passing U.S. No. 200 sieve:

$$EOS \text{ No. (fabric)} \geq 30 \text{ U.S. Std. Sieve No.}$$

B. Soils with more than 50% particles by weight passing U.S. No. 200 sieve:

$$EOS \text{ No. (fabric)} \geq 50 \text{ U.S. Std. Sieve No.}$$

Note:

- a. Whenever possible, fabric with the lowest possible EOS No. should be specified.
- b. When the protected soil contains particles from 1 inch size to those passing the U.S. No. 200 sieve, use only the gradation of soil passing the U.S. No. 4 sieve in selecting the fabric.

III. PERMEABILITY:

Critical/Severe Applications *	Normal Applications
$k \text{ (fabric)} \geq 10 k \text{ (soil)}^2$	$k \text{ (Fabric)} \geq k \text{ (soil)}^2$

\* Woven monofilament fabrics only; percent open area  $\geq 4.0$  and EOS No.  $\leq 100$  sieve.

IV. CHEMICAL COMPOSITION REQUIREMENTS/CONSIDERATIONS:

- A. Fibers used in the manufacture of civil engineering fabrics shall consist of long chain synthetic polymers, composed of at least 85% by weight of polyolefins, polyesters, or polyamides. These fabrics shall resist deterioration from ultraviolet exposure.
- B. The engineering fabric shall be exposed to ultraviolet radiation (sunlight) for no more than 30 days total in the period of time following manufacture until the fabric is covered with soil, rock, concrete, etc.

**EXHIBIT 6 - SUPPLEMENTAL SPECIFICATIONS AND FORMS**

**V. PHYSICAL PROPERTY REQUIREMENTS (all fabrics)**

	Class 1 Fabric <sup>3</sup> Protected	Class 2 Fabric <sup>3</sup> Unprotected
Grab Strength (ASTM D-4632 or ASTM D-1682)	80 lbs.	180 lbs.
Seam Strength <sup>4</sup> (ASTM D-4632 or ASTM D-1682)	70 lbs.	160 lbs.
Puncture Strength (ASTM D-3787)	25 lbs.	80 lbs.
Burst Strength (ASTM D-3786)	130 psi.	290 psi.
Trapezoid Tear (ASTM D-4533)	25 lbs.	50 lbs.
Ultraviolet Degradation at 150 hours (ASTM D-4355)	70%	70%

<sup>1</sup> All numerical values represent minimum average roll values (i.e., any roll in a lot should meet or exceed the minimum values in the table). Use values for the weaker principal direction. Lots should be sampled according to ASTM D-4354.

<sup>2</sup> Permeability should be based on the actual fabric open area available for flow. For example, if 50% of the fabric area is to be covered by flat concrete blocks, the effective flow area is reduced by 50%.

<sup>3</sup> Fabric is said to be protected when used in drainage trenches or beneath/behind concrete (Portland or asphalt cement) slabs. All other conditions are said to be unprotected,

Examples of each condition are:

Protected: highway edge drains, blanket drains, smooth stable trenches < 10 feet in depth. In trenches, in which the aggregate is extra sharp, additional puncture resistance may be necessary.

Unprotected: stabilization trenches, interceptor drains on cut slopes, rocky or caving trenches or smooth stable trenches > 10 feet in depth.

<sup>4</sup> Values apply to both field and manufactured seams.

August 1, 2013

## CRANE SAFETY

The contractor's attention is directed to the following Crane Safety criteria. All applicable items under the submittal list section shall be submitted to the Resident Construction Engineer (RCE) before any crane operations may begin. If any personnel or equipment is changed or added, all applicable items shall be updated and submitted to the RCE before continuing with crane(s) operations.

All contractors shall comply with the manufacturer specifications and limitations applicable to the operation of any and all cranes and derricks. Prime contractors and sub-contractors shall comply with the latest Occupational Safety and Health Administration (OSHA) regulations, adopted American National Standards Institute (ANSI) and American Society of Mechanical Engineers (ASME) crane standards, and other applicable standards including, but not limited to the following:

- OSHA 29 CFR 1926 Subpart CC "Cranes and Derricks in Construction"
- OSHA 29 CFR 1926.251 "Rigging Equipment for Material Handling"
- ASME B30.5-2007 "Mobile and Locomotive Cranes"
- ASME B30.8-2010 "Floating Cranes and Floating Derricks"
- ASME B30.22-2005 "Articulating Boom Cranes"
- ASME B30.26-2010 "Rigging Hardware"

### Submittal List

1. **Crane Operators:** All crane operators shall be certified by the National Commission for the Certification of Crane Operators (NCCCO), National Center for Construction Education and Research (NCCER), or Crane Institute of America Certification (CIC).
  - a. Contractor shall submit a copy of the NCCCO, NCCER, or CIC certification for each crane operator prior to performing any crane operations on the job site. The original certification card shall be available for review upon request and must remain current within a 5 year expiration date for the duration of the job. (Contractors with a crane operator-in- training on the jobsite shall comply with all the OSHA Subpart CC requirements).
  - b. Contractor shall submit a copy of the current Crane Operators Medical Evaluation card (3 year expiration) in the form of NCCCO, NCCER or CIC Physical Examination form or equivalent meeting the ASME B30.5 requirement or a current USDOT Medical Examiner's Certificate card (2 year expiration). The original medical card or equivalent for all crane operators shall be available for review upon request.
2. **Competent Person:** The named competent person will have the responsibility and authority to stop any work activity due to safety concerns.
  - a. Contractor shall submit the name and qualifications of the "Competent Person" as defined by OSHA Subpart CC responsible for all crane safety and lifting operations.

January 1, 2009

### EROSION CONTROL MEASURES

In addition to the erosion control measures specified in the Plans, Standard Specifications, Supplemental Technical Specifications and the Special Provisions, the Contractor is advised that all land disturbing activities (clearing and grubbing, excavation, borrow and fill) are subject to the requirements set forth in the following permits and regulations:

- South Carolina Code of Regulations 63-380, Standard Plan for Erosion, Sediment, and Stormwater Runoff Control.
- Erosion and Sediment Reduction Act of 1983 (Title 48, Chapter 18 of the South Carolina Code of Laws of 1983, as amended). Section 70 of this code authorized the South Carolina Department of Health and Environmental Control (SCDHEC) to administer this regulation with respect to lands under the jurisdiction of the South Carolina Department of Transportation.
- National Pollutant Discharge Elimination System (NPDES) General Permit Number SCR160000, effective January 1, 2013: The Environmental Protection Agency, in accordance with the Federal Clean Water Act, has granted to the South Carolina Department of Health and Environmental Control (SCDHEC) the authority to administer the Federal NPDES permit program in the State of South Carolina.

In accordance with the NPDES General Permit, the Contractor must sign a Contractor Certification. The certification is incorporated into the proposal form for the Contract. By signing this form, the Contractor acknowledges that upon award and execution of the Contract, he/she accepts/ understands the terms and conditions of the *Storm Water Pollution Prevention Plan (SWPPP)* as required by the NPDES General Permit and may be legally accountable to SCDHEC for compliance with the terms and conditions of the *SWPPP*. In addition, the Contractor certifies that the NPDES certification statement status is made part of all its subcontracts.

The Contractor will complete and forward an updated SCDOT approved *Notice of Intent (NOI)* to the SCDOT Construction office to submit to SCDHEC. If the Coastal Zone Consistency (CZC) permit has not been approved it shall be forwarded by the Contractor to SCDOT to submit to SCDHEC as part of *NOI* package. If SCDHEC does not send a letter within 10 business days of receipt of the *NOI*, authorizing coverage, denying coverage, or advising that a review of the *CECP* will take place, coverage will be automatically granted.

Prepare and submit a *Contractor's Erosion Control Plan (CECP)* to the RCE before the pre-construction conference. Ensure that the plan meets the requirements of the NPDES General Permit. The plan will be reviewed and approved by the Department before commencing any land disturbing activities.

At the pre-construction conference, with contactors performing land-disturbing activities present, the *CECP* will be explained and discussed so that the Contractor is made aware of their responsibilities in the *CECP*.

Once approved, fully implement the *CECP*. Coordinate the prompt installation of erosion control devices with construction activities to maintain compliance with the above regulations and NPDES General Permit.

Conduct an Erosion and Sediment Control Inspection by an appointed Certified Erosion Prevention and Sediment Control Inspector (CEPSCI) from the Contractor and the Department at least every 7-calendar days. Both parties will acknowledge participation in the inspection by signing the inspection report and include their inspector's CEPSCI number on the report. Correct deficiencies noted during these inspections within the assigned priority period. If deficiencies are not corrected within this timeframe, the RCE will stop all work (except erosion and sediment control measures) until the deficiencies are corrected.



## EXHIBIT 6 - SUPPLEMENTAL SPECIFICATIONS AND FORMS

Give special attention to critical areas within the project limits (i.e., running streams, water bodies, wetlands, etc.). In these areas, the RCE may direct the Contractor to undertake immediate corrective action, but in no case allow these deficiencies to remain unresolved more than 7 days or 48 hours in accordance with their assigned priority after being identified during the Erosion and Sediment Control Inspection.

Closely follow the grading operations with the seeding operations. Shape and prepare the slopes for seeding as the grading progresses. Unless the RCE grants prior written approval, limit the amount of surface area exposed by land disturbing activities to 750,000 square feet. Commence seeding operations within 7 days following completion of construction activities within an area.

Initiate stabilization measures within 7 days for an area where construction activities will be temporarily or permanently ceased for 14 days or longer.

Coordinate the installation of all other permanent erosion control items with the grading and seeding operations. These items include, but are not limited to, asphalt gutter and riprap. Construct gutter work before or promptly after the seeding is performed. Place riprap at the ends of pipe immediately after the pipe is laid and promptly install riprap ditch checks after ditch work has been performed.

Failure to adequately comply with the provisions as detailed above or any other required erosion control measures will result in stoppage of all contract operations (except erosion and sediment control measures) until corrective action has been taken. Additional sanctions may be invoked by the SCDHEC in accordance with their authority.

Keep the following documents at the RCE's office from the start of construction until the site is finally stabilized:

- Copy of the *CECP*,
- Copies of Contractor Certification statements,
- Copy of the permit,
- Letter from DHEC authorizing permit coverage if provided by SCDHEC, and
- A marked-up set of site plans.

When uniform perennial vegetation achieves a cover density of 70%, submit a *Notice of Termination (NOT)* to SCDHEC to terminate coverage. Include a signed statement with the *NOT* certifying that all work on the site has been completed in accordance with the *SWPPP* and the NPDES General Permit for all sites one acre or greater.

Fines assessed on the Department by SCDHEC as the result of the Contractor's non-compliance or violation of said permit provisions will be paid by the Department and will subsequently be deducted from any monies due or that may become due to the Contractor. In case no monies are due or available, the fines incurred will be charged against the Contractor's Surety.

July 1, 2011

**Erosion Control**

**Section 815.2.5.1 Posts**

Replace Section 815.2.5.1 in its entirety with the following:

Furnish steel posts a minimum of 60 inches long and meeting the minimum physical requirements specified in Subsection 815.2.12 or Furnish Rigid PVC T-posts a minimum of 60 inches long meeting the physical requirements specified in paragraph 3 of this subsection.

When sandy soils are present on site and steel posts are utilized, provide a metal plate welded near the bottom of the steel post so that when the post is driven to the proper depth, the plate is below the ground level for added stability. In areas where conditions warrant, larger posts or reduced post spacing may be required to provide an adequate fence to handle the stress from sediment loading.

Rigid PVC T-posts shall meet the following physical requirements. Material shall consist of Rigid Polyvinyl Chloride with cell classification of 30304311 as determined in accordance with ASTM D4216. Width of the flange shall be a minimum of 2.1". Depth of the web shall be a minimum of 1.625". The thickness of the flange and the thickness of the web shall each be a minimum of 0.35" at the intersection of the flange and web. Weight per unit length shall be no less than 0.8lb/ft. Posts shall have only a single 3/8" hole in the center of the web spaced every 3" in the top 3' of the post. No holes shall be present on any part of the flange. Silt fence shall be placed directly against the flange of the post, with the flange parallel to the run of silt fence. In areas where conditions warrant, reduced post spacing may be required to provide an adequate fence to handle the stress from sediment loading.

January 2, 2013

**Grout for Post-Tensioning and Prestressed Cored Slabs**

Delete Subsection 704.2.6 and 704.2.7 of the Standard Specifications in their entirety and replace them with the following:

**704.2.6 Post-Tensioning Grout**

Use a commercial premixed grout specifically designed for grouting steel cables, anchorages, and rods meeting ASTM C 1107 requirements and approved in writing by the SME or BCE. Ensure that the commercial premixed grout is non-shrink, non-corrosive and non-metallic. At the option of the contractor a mixture of cement, water, and sand in the proportions of 1 bag of cement to 50 pounds of sand (all passing the No. 30 sieve) to about 5½ gallons of water may be used instead of the commercial premixed grout. Ensure that the sand and cement are from sources listed on the most recent editions of *SCDOT Qualified Products List 1* and *SCDOT Qualified Products List 6*. Ensure that water meets the requirements of **Subsection 701.2.11**. Use the amount of water necessary to provide a grout of the consistency of thick paint. The sand may be omitted if desired, but take care to obtain the consistency stated above. Mix the grout in a mechanical mixer for at least 2 minutes and keep it constantly agitated.

**704.2.7 Grout for Prestressed Cored Slabs**

Use a non-shrink, non-corrosive, and non-metallic grout meeting ASTM C 1107 requirements and approved in writing by the SME or BCE in the shear keys, dowel holes, and all recesses in the prestressed concrete of cored slabs that reaches a compressive strength of 5000 psi in 24 hours.

September 1, 2013

**WORK ZONE TRAFFIC CONTROL  
TRAINING REQUIREMENTS  
FOR  
CONTRACTORS / SUBCONTRACTORS**

**1. Description:**

This specification details the work zone traffic control training requirements for employees and representatives of a contractor or subcontractor under contract to the South Carolina Department of Transportation (SCDOT) whose job duties include responsibilities relative to implementation and maintenance of the Transportation Management Plan (TMP). "Employees and representatives of a contractor or subcontractor" will henceforth be referred to as "employee" or "employees" and "contractor or subcontractor" will henceforth be referred to as "contractor".

The SCDOT requires the contractor to provide documentation to substantiate successful completion and attainment of a passing score of a prescribed training course conducted by an SCDOT approved provider by those employees whose job duties categorize them as "designated trainees" as defined hereinafter.

**2. Implementation:**

These requirements for work zone traffic control training for employees of those entities under contract to the SCDOT whose job duties include responsibilities relative to implementation and maintenance of a TMP shall become effective on all projects let to contract after September 1, 2013.

**3. Designated Trainees:**

An employee whose job duty responsibilities, as designated hereto, impact or involve any of or all of the components of a TMP must successfully complete an advanced work zone traffic control training program. These components include the primary component, the "Temporary Traffic Control" plan, and the secondary components, the "Transportation Operations" plan and the "Public Information" plan.

An employee whose job duties include any of the following responsibilities regarding the TMP shall successfully complete an advanced work zone traffic control training program conducted by an SCDOT approved work zone traffic control training provider:

- Supervision of the field installation of any or all components of the TMP
- Supervision of the maintenance of any or all components of the TMP
- Supervision of the removal of any or all components of the TMP
- Design and development of revisions to an existing TMP
- Design and development of a new or alternate TMP
- Any decision-making responsibilities regarding the TMP

Those employees whose job duties do not include responsibilities relative to the TMP as stated above are not required to attend an advanced work zone traffic control training program. However, it is recommended that all employees whose job duties place them on the job site within the highway rights-of-way within 30 feet or less of a travel lane open to traffic should attend a basic work zone traffic control training course.

Also, an employee whose job duties include "flagger" shall successfully complete a "Flagger Training" course. However, regarding an employee whose job duties include "flagger" but does not involve any of the responsibilities listed above, successful completion of a "Flagger Training" course is the only mandatory work zone traffic control training course required for this employee; other work zone traffic control training courses are elective.

**4. Approved Work Zone Traffic Control Training Providers:**

The SCDOT recognizes the following organizations as acceptable providers of an advanced work zone traffic control training program, a “Flagger Training” course or the optional basic work zone traffic control training course:

American Traffic Safety Services Association (ATSSA)  
Institute for Transportation Research and Education at North Carolina State University (ITRE)  
Carolinas Association of General Contractors (AGC)  
National Safety Council South Carolina Chapter

These organizations provide work zone traffic control training in compliance with the MUTCD and reference requirements specific to SCDOT. Therefore, work zone traffic control training provided by entities other than those listed above are not considered comparable and shall be unacceptable.

Specific course material for work zone traffic control training courses designated as “Basic”, “Advanced”, “Supervisor” or “Flagger” and any additional training courses not specified here is determined by the work zone traffic control training course provider and has undergone review and received acceptance by SCDOT. Also, the passing score for each training course is determined by the work zone traffic control provider.

**5. Training Requirements / Qualifications:**

Successful completion of an advanced work zone traffic control training program is defined as achieving a passing score in all courses, including any prerequisite courses, to attain a level considered “advanced”, “supervisor” or any other relative term as designated by the provider to imply the trainee has an understanding of the course material inclusive of design, implementation and maintenance of work zone traffic control scenarios. Upon successful completion of the program, the trainee should also possess an understanding for determining the need for and developing and implementing adjustments as necessary when applying typical work zone traffic control applications to non-typical work site conditions and scenarios.

The employee whose job duty responsibilities mandate successful completion of an advanced work zone traffic control training program shall do so prior to performing any job duties with responsibilities relative to design and development of a TMP or revisions of an existing TMP or any decision-making responsibilities regarding the TMP or supervision of the field installation and maintenance of any and all components of the TMP.

Also, an employee whose job duties mandate successful completion of a “Flagger” training course shall do so prior to performing any job duties relative to flagging traffic.

Each employee who has successfully completed an approved advanced work zone traffic control training program or a “Flagger” training course shall attend and complete a refresher course relative to the employee’s job duties on a 5-year incremental time frame.

**6. Documentation:**

The contractor shall provide proof of successful completion of an acceptable advanced work zone traffic control training class by those employees whose job duty responsibilities mandate successful completion of approved work zone traffic control training to the Resident Engineer prior to the employee performing the job duties that incorporate responsibilities which necessitate approved work zone traffic control training. For proof of successful completion of an approved work zone traffic control training class, provide a copy of the certificate of training from the organization who conducted the training to the Resident Engineer. Failure to provide the required documentation as specified shall prevent SCDOT acceptance of the employee as properly trained and acceptable for conducting those job duties that necessitate the prescribed work zone traffic control training.

EXHIBIT 6 - SUPPLEMENTAL SPECIFICATIONS AND FORMS

The contractor shall provide proof of successful completion of an acceptable "Flagger Training" course by all employees whose job duties require them to be the "Flagger" within a flagging operation to the Resident Engineer prior to the employee performing any "Flagger" job duties.

The contractor shall provide proof of successful completion of an acceptable advanced work zone traffic control refresher course for those employees no later than 60 days beyond the 5 year anniversary date of the employee's certificate date of completion of a previous advanced work zone traffic control training program.

Documentation of proof of completion of a basic work zone traffic control training course by employees whose job duties require their presence on the job site within the highway rights-of-way but exclude any responsibilities relative to the TMP is not required.



Form 616 (7/10/89)

**CONTRACTOR NOTICE OF CLAIM**

DATE: \_\_\_\_\_

FILE NO. \_\_\_\_\_

CONTRACTOR: \_\_\_\_\_

NOTICE OF CLAIM FOR ADJUSTMENT DUE TO: (circle as appropriate)

ALTERATION  
OF PLANS

CHANGED/DIFFERING  
SITE CONDITIONS

DELAY/SUSPENSION  
OF WORK

EXTRA WORK

TIME EXTENSION

OTHER

NATURE OF THE EVENT:

CAUSE OF THE EVENT:

IMPACT OF THE EVENT: (on time of performance on contract price)

In the event this issue is not resolved by Supplemental Agreement or Force Account Order, the Contractor shall submit to the Department at the appropriate time a fully detailed request ("Claim") for additional time or compensation.

Copy of this notice was delivered to the RESIDENT ENGINEER on

\_\_\_\_\_, 20\_\_ by\_\_\_\_\_.

SIGNED: \_\_\_\_\_  
(Contractor's Representative)

RECEIVED BY:

\_\_\_\_\_  
RESIDENT ENGINEER

DATE: \_\_\_\_\_

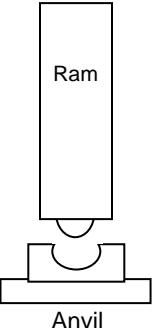

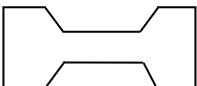



EXHIBIT 6 - SUPPLEMENTAL SPECIFICATIONS AND FORMS

Director of Construction

Date Sent to FHWA \_\_\_\_\_

**EXHIBIT 6 - SUPPLEMENTAL SPECIFICATIONS AND FORMS**

File No.:		Project No. (PIN):				
County:		Route:				
Description:						
Contractor:						
 <p>Ram</p> <p>Anvil</p>	<b>Hammer</b>	Manufacturer:	Model:			
		Type:	Serial No.:			
		Rated Energy (k-ft)	at	Length of stroke (ft)		
		Lead Size (in):				
		Modifications:				
		<b>Note:</b> Attach any hammer modification specifications. Manufacturer's Specifications may be required if hammer is not found in Wave Equation database.				
		Date of Last Maintenance:				
		Type of Maintenance:				
		Performed By:				
	<b>Striker Plate</b>	Weight (kips):				
		Diameter (in):	Thickness (in):			
	<b>Hammer Cushion</b>	Description:				
		Material Description		No. of Layers	Modulus of Elasticity (ksi)	Thickness (in)
		1				
		2				
		Area (sq. in):		Total Thickness (in)		
Coefficient of Restitution:						
	<b>Pile Cap (Helmet)</b>	Dimension:				
		Pile Cap Weight (kips):				
		Inserts Weight (kips):				
	<b>Pile Cushion</b>	Material:				
		Thickness (in.):	Area (sq. in):			
		Modulus of Elasticity (ksi):				
		Coefficient of Restitution:				
	<b>Pile</b>	Pile Type/Size & Pile Point:				
		Total Pile & Point Length (ft):	Exposed Pile Point Length (ft):			
		Pile Cross-Sectional Area (sq.in):				
		Pipe Pile Wall Thickness (in):				
		Pile Tip Description:				
		Splice Description:				
		Splice Location From Pile Top (ft):				
		Concrete Pile Strength, $f'_c$ (psi):				
		Steel Pile Yield Strength, $F_y$ (ksi):				
<b>Note:</b> Within 30 calendar days after award of contract or no later than 30 days before driving the first pile, submit form and Pile Installation Plan to the Geotechnical Design Support Engineer, with copy to the Bridge Construction Engineer and RCE.						
SCDOT – Preconstruction Support Geotechnical Design Support Engineer P.O. Box 191 Columbia, SC 29202-0191 Telephone (803) 737-1571 FAX (803) 737-0608		Submitted By:				
		Title:				
		Telephone No.	( )-	Date:		





## HOW TO COMPLETE THE DRILLED SHAFT LOG



Project Name _____	Page _____ of _____	
Project No. _____	Plan No. _____	
Contract # _____	Sheet No. _____	
Inspected By _____	Date     Station _____	
Approved By _____	Date     Sheet _____	

Date Closed _____	Coaming Type _____	
Date Opened _____	Coaming Dimension _____	
Date Poured _____	Bottom of Coaming Elevation (ft) _____	
Diameter (ft) 	Diameter of Rock Socket (in) _____	
	Diameter of Overburden Shaft (in) _____	
	Median Ground Surface Elevation (ft) _____	
	Overburden Shaft Length (ft) _____	
	Rock Socket Length (ft) _____	
	Culvert Elevation (ft) _____	
	Top Elevation (ft) _____	
	Constructed Shaft Length (ft) _____	
	Feeling (ft) _____	
	Volume of Concrete - Theoretical (cy) _____	
Actual (cy) _____		
Reinforcement Cage Installed _____		
Duration of Pour (min) _____		
Legend ROC Top of Coaming <input type="checkbox"/> Sand FOG Top of Ground <input type="checkbox"/> Silt FOS Top of Shaft <input type="checkbox"/> Clay FOR Top of Rock <input type="checkbox"/> Rock BOC Bottom of Coaming <input type="checkbox"/> BOS Bottom of Shaft <input type="checkbox"/>		
Water Level _____ Inspected by _____ Field Engineer _____ Approved by _____ Project Engineer _____ Distribution _____		

Fill in every blank on the form. If it does not apply put an "N/A" or a long dash.

Use pencil – but never erase. If you need to change something, strike a single line through the item and insert the correct information above it. If there is insufficient room to make a note, footnote the item and go to the bottom of the page, or use a separate page.

1. Heading:
  - Fill in before drilling starts.
  - Be sure to print your name and the start date of drilling.
  - The Geotechnical Engineer will sign approval line.
2. Shaft Data: - Fill in appropriate dates, elevations, and diameters.
3. Concrete Data: Record data from the Concrete Volumes form.
4. Construct Shaft Illustration using the symbols provided.
5. Fill in "Inspected by" and "Distribution".



**DRILLED SHAFT LOG (REV 06-03-02)**  
**SAMPLE 1 Construction Casing**

Project Name	Replace Bridge over Cooper Creek along US-322	Page	1	of	6
File No.	4.995	Bent No.	3		
Contractor	Drilled Shaft, Inc.	Shaft No.	3		
Completed By Contractor	DS Foreman - John Q. Doe	Date	06/05/02	Station	508 + 36
Reviewed By SCDOT	Inspector - John Smith	Date	06/05/02	Offset	24 FT. Right

Date Cased 06/04/02  
 Date Opened 06/04/02  
 Date Poured 06/05/02

Casing Type:  
 Casing Dimension (OD):  
 Bottom of Casing Elevation (FT)  
 Top of Casing Elevation (FT)  
 Diameter of Rock Socket (IN)  
 Diameter of Shaft (IN)  
 Mud-line/Ground Surface Elev. (FT)  
 Wet & Dry Shaft Length (FT)  
 Rock Socket Length (FT)  
 Top of Shaft Elevation (FT)  
 Tip Elevation (FT)  
 Constructed Shaft Length (FT)

Construction	Temporary
Steel	
48.0 IN.	
86.0 FT. msl	
101.0 FT. msl	
42.0 IN.	
37 Ft. @ +48.0 IN. & 15 FT. @ 47 IN.	
100.0 FT. msl	
52.0 FT.	
10.0 FT. @ 42IN.	
101.0 FT. msl	
39.0 FT. msl	
62.0 FT.	

Testing/Other: Slurry, Slump, Air, Compression Cylinders, & CSL

Volume of Concrete: Theoretical (VT) CY 27.2  
 OP = VP-VT = 0.6 CY UP = VT - VP= Actual (VP) CY 27.8  
 Reinforcement Cage Installed: Type Spiral  
 Duration of Pour (min) 100 Min.

**Legend**

TOC	Top of Casing		Sand
TOG	Top of Ground		Silt
TOS	Top of Shaft		Clay
TOR	Top of Rock		Rock
BOC	Bottom of Casing		
BOS	Bottom of Shaft		
BOR	Bottom of Rock		

Water Level

Completed by \_\_\_\_\_  
 Contractor DS Foreman/Engineer - John Q Doe

Reviewed by \_\_\_\_\_  
 SCDOT Inspector/Engineer - John Smith

Notes: \_\_\_\_\_  
 Shaft location variance at top: 2" after plan station & 1" right.

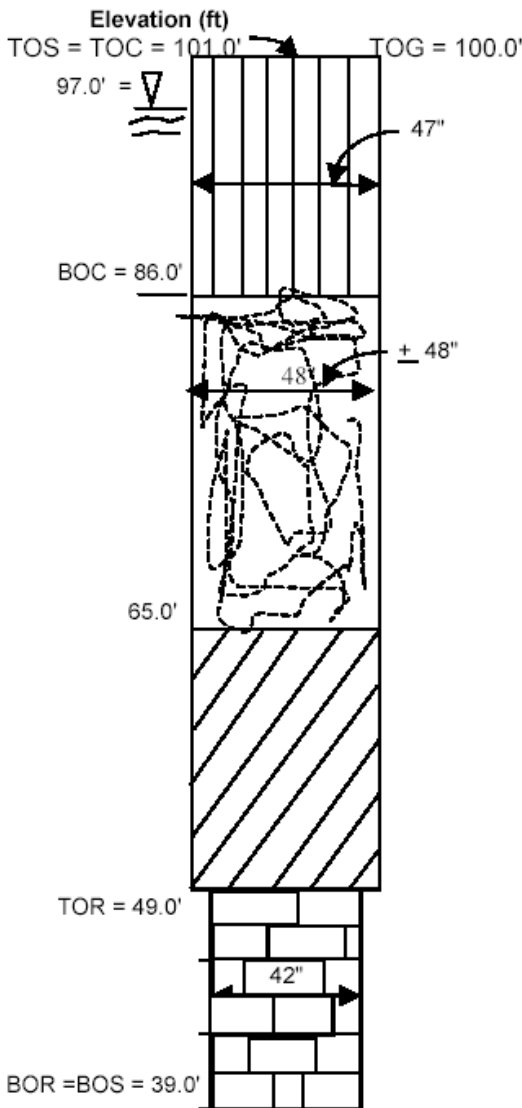





**DRILLED SHAFT LOG (REV 06-03-02)**  
**SAMPLE 2 Temporary Casing**

Project Name	Replace Bridge over Cooper Creek along US-322	Page	1	of	6
File No.	4.995	Bent No.	6		
Contractor	Drilled Shaft, Inc.	Shaft No.	3		
Completed By Contractor	DS Foreman - John Q. Doe	Date	06/05/02	Station	508 + 36
Reviewed By SCDOT	Inspector - Jane Smith	Date	06/05/02	Offset	24 FT. Right

Date Cased	06/04/02	Casing Type:	Construction	Temporary
Date Opened	06/04/02	Casing Dimension (OD):		Steel
Date Poured	06/05/02	Bottom of Casing Elevation (FT)		48.0 IN.
		Top of Casing Elevation (FT)		86.0 FT.
		Diameter of Rock Socket (IN)		101.0 FT.
		Diameter of Shaft (IN)		42.0 IN.
		Mud-line/Ground Surface Elev. (FT)		+ 48.0 IN.
		Wet & Dry Shaft Length (FT)		100.0 FT. msl
		Rock Socket Length (FT)		51.0 FT.
		Top of Shaft Elevation (FT)		10.0 FT.
		Tip Elevation (FT)		100.0 FT. msl
		Constructed Shaft Length (FT)		39.0 FT. msl
		Testing/Other: Slurry, Slump, Air, Compression Cylinders, & CSL		61.0 FT.
		Volume of Concrete:	Theoretical (VT) CY	27.3
		OP = VP-VT = 0.5 CY UP = VT - VP=	Actual (VP) CY	27.8
		Reinforcement Cage Installed:	Type: Welded Hoops	
		Duration of Pour (min)	100 Min.	

<b>Legend</b>			
TOC	Top of Casing		Sand
TOG	Top of Ground		
TOS	Top of Shaft		Silt
TOR	Top of Rock		
BOC	Bottom of Casing		Clay
BOS	Bottom of Shaft		
BOR	Bottom of Rock		Rock

Water Level

Completed by \_\_\_\_\_  
 Contractor DS Foreman/Engineer - John Q Doe  
 Reviewed by \_\_\_\_\_  
 SCDOT Inspector/Engineer - Jane Smith  
 Notes: \_\_\_\_\_  
 Shaft location variance at top: 1" after plan station & 4" left. Called Bridge Construction Engineer prior to pour. Received verbal approval to cast concrete from BCE. Contractor told to submit letter covering this shaft variance.





DRILLED SHAFT EXCAVATION LOG (REV 06-03-02)

Project Name _____		Page <u>2</u> of <u>6</u>
File No. _____		Bent No. _____
Contractor _____		Shaft No. _____
Completed By Contractor <u>DS Foreman -</u>	Date <u> / /</u>	Station _____
Reviewed By SCDOT <u>Inspector -</u>	Date <u> / /</u>	Offset _____

**Note: Preaugering not allowed when using construction casing.**

Casing Information					
ID	OD	Top Elev.	Length	Bot. Elev.	
_____	_____	_____	_____	_____	Soil Auger Diam. _____
_____	_____	_____	_____	_____	Rock Core Diam. _____
_____	_____	_____	_____	_____	Ground Surface Elev. _____
_____	_____	_____	_____	_____	Water Table Elev. _____
_____	_____	_____	_____	_____	Reference Elev. _____
_____	_____	_____	_____	_____	Drilling Mud _____
Notes _____					

Depth ( )	Elev. ( )	Time		Soil Description and Notes
			In	
			Out	
			In	
			Out	
			In	
			Out	
			In	
			Out	
			In	
			Out	
			In	
			Out	
			In	
			Out	
			In	
			Out	



## HOW TO COMPLETE THE DRILLED SHAFT EXCAVATION LOG



Project Name _____		Page _____ of _____	
Contract No. _____		Plan No. _____	
Inspected By _____		Date: / /	Station: _____
Approved By _____		Date: / /	Offset: _____
<b>Casing Information</b>			
ID _____	OD _____	Top Elev. _____	Length _____
		Soil Auger Diam. _____	Ground Surface Elev. _____
		Water Table Elev. _____	Reference Elev. _____
		Drilling Mud _____	
Notes _____			
Depth	Elev.	Time	Soil Description and Notes
		In	
		Out	
		In	
		Out	
		In	
		Out	
		In	
		Out	
		In	
		Out	
		In	
		Out	
		In	
		Out	
		In	
		Out	
		In	
		Out	
		In	
		Out	

Fill in every blank on the form. If it does not apply put an "N/A" or a long dash.

Use pencil – but never erase. If you need to change something, strike a single line through the item and insert the correct information above it. If there is insufficient room to make a note, footnote the item and go to the bottom of the page, or use a separate page.

1. **Heading:**
  - Fill in before drilling starts.
  - Be sure to print your name and the start date for drilling.
  - The Geotechnical Engineer will sign approval line.
  
2. **Casing:**
  - Measure Length (L) in the field.
  - Surveyor provides Top of Casing elevation (TE).
  - Compute bottom elevation(BE):  $TE-L=BE$
  
3. **Site Data**
  - Soil Auger diameter – measure and record in inches.
  - Ground surface elev. – provided by surveyor.
  - Water table elev. – measure w/tape in hole before slurry is introduced (if applicable).
  - Water table may need to be estimated from seepage in dry hole method.
  - Reference Elevation – provided by surveyor.
  - Drill mud – If used, complete the "**Slurry Inspection Log**"; compare to Installation Plan
  
4. **Depth/Elevation:**
  - Depth (D) can be measured by:
    - 1) Contractor has kelly bar marked (spot checking only)
    - 2) Weighted tape (for accurate measurements)
 Reference elevation is always known; i.e., template, top of casing, or top of ground.
  
  - Elevation (E) – compute  $TE-D=E$
  - Enter Depth/Elev. For EVERY change in the soil/rock condition.
  
5. **Time:**
  - May use military or 24 hour clock. Be consistent and correct! Remember that shaft drilling can occur over several days, so be sure to mark date changes.
  
6. **Material:**
  - Use this form to record all activity during shaft excavation. Label all major soil strata.

EXHIBIT 6 - SUPPLEMENTAL SPECIFICATIONS AND FORMS



**DRILLED SHAFT EXCAVATION LOG (REV 06-03-02)  
SAMPLE 1 Construction Casing**

Project Name	Replace Bridge over Cooper Creek along US-322	Page	2	of	6
File No.	4.995	Bent No.	3		
Contractor	Drilled Shaft, Inc.	Shaft No.	3		
Completed By Contractor	DS Foreman - John Q. Doe	Date	06/03/02	Station	508 + 36
Reviewed By SCDOT	Inspector - John Smith	Date	06/03/02	Offset	24 Ft. Right

**Note: Preaugering not allowed when using construction casing.**

Casing Information: Construction <input checked="" type="checkbox"/> Temporary <input type="checkbox"/>					Soil Auger Diam.	46"
ID	OD	Top Elev.	Length	Bot. Elev.	Rock Core Diam.	42"
47"	48"	101.0 MSL	15'	86.0 MSL	Ground Surface Elev.	100.0 MSL
					Water Table Elev.	97.0 MSL
					Reference Elev.	101.0 MSL
					Drilling Mud	Slurry
Notes	Switched to 42" Rock Core @ 52.0' (49.0' MSL) at 1:50 pm.					

Depth (Feet)	Elev. (Ft. MSL)	Time		Soil Description and Notes
1.0	100.0	7:30 am	In	Tan Silty Sand
15.0	86.0	9:00 am	Out	Tan Silty Sand
15.0	86.0	9:10 am	In	Dark Tan Sand
36.0	65.0	11:30 am	Out	Dark Tan Sand
36.0	65.0	11:40 am	In	Dense Silty Sand (PWR) w/Mica
52.0	49.0	1:30 pm	Out	Dense Silty Sand (PWR) w/Mica
52.0	49.0	1:50 pm	In	Very Dense Rock (Granite)
61.0	40.0	4:50 pm	Out	Very Dense Rock (Granite)
61.0	40.0	7:15 am	In	Very Dense Rock (Granite) Continued drilling from previous day
62.0	39.0	7:30 am	Out	Very Dense Rock (Granite) Continued drilling from previous day
			In	
			Out	
			In	
			Out	
			In	
			Out	
			In	
			Out	
			In	
			Out	

EXHIBIT 6 - SUPPLEMENTAL SPECIFICATIONS AND FORMS



**DRILLED SHAFT EXCAVATION LOG (REV 06-03-02)  
SAMPLE 2 Temporary Casing**

Project Name	<u>Replace Bridge over Cooper Creek along US-322</u>	Page	<u>2</u>	of	<u>6</u>
File No.	<u>4.995</u>	Bent No.	<u>6</u>		
Contractor	<u>Drilled Shaft, Inc.</u>	Shaft No.	<u>3</u>		
Completed By Contractor	<u>DS Foreman - John Q. Doe</u>	Date	<u>06/03/02</u>	Station	<u>508 + 36</u>
Reviewed By SCDOT	<u>Inspector - Jane Smith</u>	Date	<u>06/03/02</u>	Offset	<u>24 Ft. Right</u>

**Note: Preaugering not allowed when using construction casing.**

Casing Information: Construction _____ Temporary <u>X</u>					Soil Auger Diam.	<u>46"</u>
ID	OD	Top Elev.	Length	Bot. Elev.	Rock Core Diam.	<u>42"</u>
<u>47"</u>	<u>48"</u>	<u>101.0 MSL</u>	<u>15'</u>	<u>86.0 MSL</u>	Ground Surface Elev.	<u>100.0 MSL</u>
_____	_____	_____	_____	_____	Water Table Elev.	<u>97.0 MSL</u>
_____	_____	_____	_____	_____	Reference Elev.	<u>101.0 MSL</u>
_____	_____	_____	_____	_____	Drilling Mud	<u>Slurry</u>
Notes	<u>Switched to 42" Rock Core @ 52.0' (49.0' MSL) at 1:50 pm.</u>					

Depth (Feet)	Elev. (Ft. MSL)	Time		Soil Description and Notes
		In	Out	
1	100.0	7:30 am	In	Tan Silty Sand
15.0	86.0	9:00 am	Out	Tan Silty Sand
15.0	86.0	9:10 am	In	Dark Tan Sand
36.0	65.0	11:30 am	Out	Dark Tan Sand
36.0	65.0	11:40 am	In	Dense Silty Sand (PWR) w/Mica
52.0	49.0	1:30 pm	Out	Dense Silty Sand (PWR) w/Mica
52.0	49.0	1:50 pm	In	Very Dense Rock (Granite)
61.0	40.0	4:50 pm	Out	Very Dense Rock (Granite)
61.0	40.0	7:15 am	In	Very Dense Rock (Granite) Continued drilling from previous day
62.0	39.0	7:30 am	Out	Very Dense Rock (Granite) Continued drilling from previous day
			In	
			Out	
			In	
			Out	
			In	
			Out	
			In	
			Out	





SLURRY INSPECTION LOG (REV 06-03-02)

Project Name			
File Number			
Bent No.	Shaft No.	Brand	Proportions
Water Source: *		Mineral Type	Type
Date of Initial Hydration	/ /	Additives	
	Time		

TEST PROPERTIES

Sampling	Before Introduction of Slurry	First 8 Hours During Construction **				Additional Testing		At End of Excavation	Before Concreting Test 1	Before Concreting Test 2
		Test 1	Test 2	Test 3	Test 4	Test 1	Test 2			
Date:										
Time:										
Test Depth at Levels:	Holding Tank						At Bottom	At Bottom	At Bottom	
Density										
Viscosity										
% Sand										
pH										
Cake / Filtrate	N/A									

Notes: \* Salt water shall not be used to hydrate the slurry or stabilize the excavation.

\*\* A minimum of 4 sets of tests shall be made during the first 8 hours of slurry use. Slurry sampling and testing shall be observed by the Engineer. When the results show consistent behavior, the testing frequency may be decreased to 1 set every 4 hours of slurry use.

Contractor DS Foreman: \_\_\_\_\_ Date: / /

SCDOT Inspector: \_\_\_\_\_ Date: / / Page 3 of 6

**EXHIBIT 6 - SUPPLEMENTAL SPECIFICATIONS AND FORMS**

**HOW TO COMPLETE THE  
SLURRY INSPECTION LOG**

SLURRY INSPECTION LOG

Project No. _____	<b>1</b>	Composition:	Brand	Type	Proportions
Drilled Shaft No. _____		Mineral Type	<b>2</b>		
Shaft Location _____		Additives			
Water Source: " _____					

TEST PROPERTIES

Sampling	Before Introduction of Slurry	First 8 Hours During Construction*				Additional Testing		At End of Excavation	Before Concreting Test 1	Before Concreting Test 2
		Test 1	Test 2	Test 3	Test 4	Test 1	Test 2			
Date:										
Time:										
Properties	Test Depth at Level:		<b>3</b>					At Bottom	At Bottom	At Bottom
Density										
Viscosity										
% Sand										
pH										
Cake / Filtrate										

Notes: \* A minimum of 4 sets of tests shall be made during the first 8 hours of slurry use. Slurry sampling and testing shall be observed by the Engineer. When the results show consistent behavior, the testing frequency may be decreased to 1 set every 4 hours of slurry use.

\*\* Salt water shall not be used to hydrate the slurry \_\_\_\_\_ the excavation.

\_\_\_\_\_  
 \_\_\_\_\_

Contractor Representative: \_\_\_\_\_ **5** \_\_\_\_\_ Date: / /  
 State Inspector: \_\_\_\_\_ Date: / /

1. Heading: - Fill in before drilling starts.  
 - The Project Resident Engineer will sign approval line.
2. Slurry Data: - Fill in appropriate brands, types, and proportion.
3. Test Data: - Record test data as the testing Inspector performs the tests.  
 - Note the depth at which the samples were obtained.  
 - Make sure that a minimum of 4 tests are performed within the first 8 hours of slurry use.
4. Notes: Record any unusual events or results.
5. Fill in "Contractor Representative" and "State Inspector".

Fill in every blank on the form. If it does not apply put an "N/A" or a long dash.

Use pencil – but never erase. If you need to change something, strike a single line through the item and insert the correct information above it. If there is insufficient room to make a note, footnote the item and go to the bottom of the page, or use a separate page.





**SLURRY INSPECTION LOG (REV 06-03-02)  
SAMPLE 1 Construction Casing**

Project Name Replace Bridge over Cooper Creek along US-322  
 File Number 4.995  
 Bent No. 3 Shaft No. 3  
 Water Source: \* Hydrant (City water)  
 Date of Initial Hydration 06/03/02 Time 9:00 am

Composition:		Brand	Type	Proportions
Mineral Type	Augua Gel	Bentonite	1400 LBS / 5000 GAL	
Additives				

**TEST PROPERTIES**

Sampling	Before Introduction of Slurry	First 8 Hours During Construction **				Additional Testing		At End of Excavation	Before Concreting Test 1	Before Concreting Test 2
		Test 1	Test 2	Test 3	Test 4	Test 1	Test 2			
Date:	06/04/02	06/04/02	06/04/02	06/04/02	06/04/02		06/05/02	06/05/02	06/05/02	06/05/02
Time:	11:00 am	1:30 pm	2:30 pm	4:00 pm	5:00 pm		7:30 am	8:15 am	9:20 am	
Test Depth at Levels:	Holding Tank	50 FT	53 FT	58 FT	60 FT		At Bottom	At Bottom	At Bottom	At Bottom
Density	65	67.1	67.3	65.8	66.3		69.1	66.1	66.3	
Viscosity	33	37	38	36	37		42	38	37	
% Sand	0%	3%	4%	2%	2.5%		10%	2%	2%	
pH	10	9	9	9	9		9	10	10	

Notes: \* Salt water shall not be used to hydrate the slurry or stabilize the excavation.

\*\* A minimum of 4 sets of tests shall be made during the first 8 hours of slurry use. Slurry sampling and testing shall be observed by the Engineer. When the results show consistent behavior, the testing frequency may be decreased to 1 set every 4 hours of slurry use.

Note: Side of shaft caked. Cleaned shaft sides.

Contractor DS Foreman: John Q. Doe Date: 06/05/02  
 SCDOT Inspector: John Smith Date: 06/05/02 Page 3 of 6





**SLURRY INSPECTION LOG (REV 06-03-02)  
SAMPLE 2 Temporary Casing**

Project Name Replace Bridge over Cooper Creek along US-322

File Number 4,995

Bent No. 6 Shaft No. 3

Water Source: \* Hydrant (City water)

Date of Initial Hydration 06/03/02 Time 9:00 am

Composition:	Brand	Type	Proportions
Mineral Type	Augua Gel	Bentonite	1400 LBS / 5000 GAL
Additives			

**TEST PROPERTIES**

Sampling	Before Introduction of Slurry	First 8 Hours During Construction **				Additional Testing		At End of Excavation	Before Concreting Test 1	Before Concreting Test 2
		Test 1	Test 2	Test 3	Test 4	Test 1	Test 2			
Date:	06/04/02	06/04/02	06/04/02	06/04/02	06/04/02		06/05/02	06/05/02	06/05/02	
Time:	11:00 am	1:30 pm	2:30 pm	4:00 pm	5:00 pm		7:30 am	8:15 am	9:20 am	
Test Depth at Levels:	Holding Tank	50 FT	53 FT	58 FT	60 FT		At Bottom	At Bottom	At Bottom	
Density	65	67.1	67.3	65.8	66.3		69.1	66.1	66.3	
Viscosity	33	37	38	36	37		42	38	37	
% Sand	0%	3%	4%	2%	2.5%		10%	2%	2%	
pH	10	9	9	9	9		9	10	10	

Notes: \* Salt water shall not be used to hydrate the slurry or stabilize the excavation.

\*\* A minimum of 4 sets of tests shall be made during the first 8 hours of slurry use. Slurry sampling and testing shall be observed by the

Engineer. When the results show consistent behavior, the testing frequency may be decreased to 1 set every 4 hours of slurry use.

Note: Side of shaft caked. Cleaned shaft sides.

Contractor DS Foreman: John Q. Doe Date: 06/05/02

SCDOT Inspector: Jane Smith Date: 06/05/02 Page 3 of 6





EXHIBIT 6 - SUPPLEMENTAL SPECIFICATIONS AND FORMS

NOTE: Specification Tolerances - Location Variance at Top = 3 inches Max. Vertical (Plumbness) = 1 inch per 4 Ft. Max.

## HOW TO COMPLETE THE DRILLED SHAFT INSPECTION LOG



Fill in every blank on the form. If it does not apply put an "N/A" or a long dash.

Use pencil – but never erase. If you need to change something, strike a single line through the item and insert the correct information above it. If there is insufficient room to make a note, footnote the item and go to the bottom of the page, or use a separate page.

1. **Heading:**
  - Fill in before drilling starts.
  - Be sure to print your name and the start date of drilling.
  - The Project Resident Engineer or designated representative will sign approval line.
  
2. **Shaft Status:**

Drill Fluid Check – Responsibility of Contractor. Record density check performed by Contractor or Inspector.

Type of Drill Fluid – record	
a)	Natural
b)	Mineral (commercial)
c)	Plain water
Remember: Polymer slurry not allowed	

  - Bottom Cleanout Method: Observe and record equipment type (i.e., cleanout bucket, air lift, submersible pump, etc.). Must match Installation Plan.
  - Time/Date Final Cleanout: Record when last cleanout performed prior to rebar cage placement.
  - Shaft Bottom Elevation – Use weighted tape to measure; record.
  - Estimate Shaft Bottom Diameter – record auger diameter.
  
3. **Cage Check:**
  - Reinforcing cage usually checked by others.
  - Proper number of Vertical bars – count and record # of vertical bars in hole; compare to plan.
  - Epoxy – you should never see coated rebar
  
4. **Shaft Cleanliness:**
  - check procedure being used, record
    - 1) Using S.I.D., visually inspect the shaft bottom in each of a minimum of 5 locations as shown on form.
    - 2) Using a weighted tape, sound the shaft in each of a minimum of 5 locations as shown on form. “Feel” for hard bottom – it translates to clean hole. Remember specifications.
  
5. **Record Results:**







**DRILLED SHAFT INSPECTION LOG (REV 06-03-02)**  
**SAMPLE 2 Temporary Casing**

Project Name	Replace Bridge over Cooper Creek along US-322	Page	4	of	6
File No.	4.995	Bent No.	6		
Contractor	Drilled Shaft, Inc.	Shaft No.	3		
Completed By Contractor	DS Foreman - John Q. Doe	Date	06/05/02	Station	508 + 36
Reviewed By SCDOT	Inspector - Jane Smith	Date	06/05/02	Offset	24 FT. Right

Type of Drilling Fluid	Bentonite	Shaft Plumbness Check/4'	1/2 In. per 4 Ft.
DS Location Variance at Top	1" Before Sta. & 4" Left**	Rebar Cage: Proper # Vert. Bars	16 EA # 36 Bars
Bottom Cleanout Method	Airlift	Proper # Horiz. Bars	# 19 W Hoops @ 7 IN.
Time/Date Final Cleanout	7:45 am on 06/05/02	Side Spacers	4 EA every 10 Ft.
Shaft Bottom Elev.	39.0 msl	Bottom Spacers	16 EA @ 6" Length
Est. Shaft Bottom Dia.	42 Inches	Ties & Connections	Checked and okay.

Inspected By: JQD Visual  Sounding  **N\*** \* Based on Compass Direction

Time Test Started 7:45 am

Time Test Finished 8:00 am

**Time Test Started** 9:10 am

**Time Test Finished** 9:25 am

Test just prior to placing Rebar cage  (inches)

Test just prior to placing concrete  (inches)

\* Direction

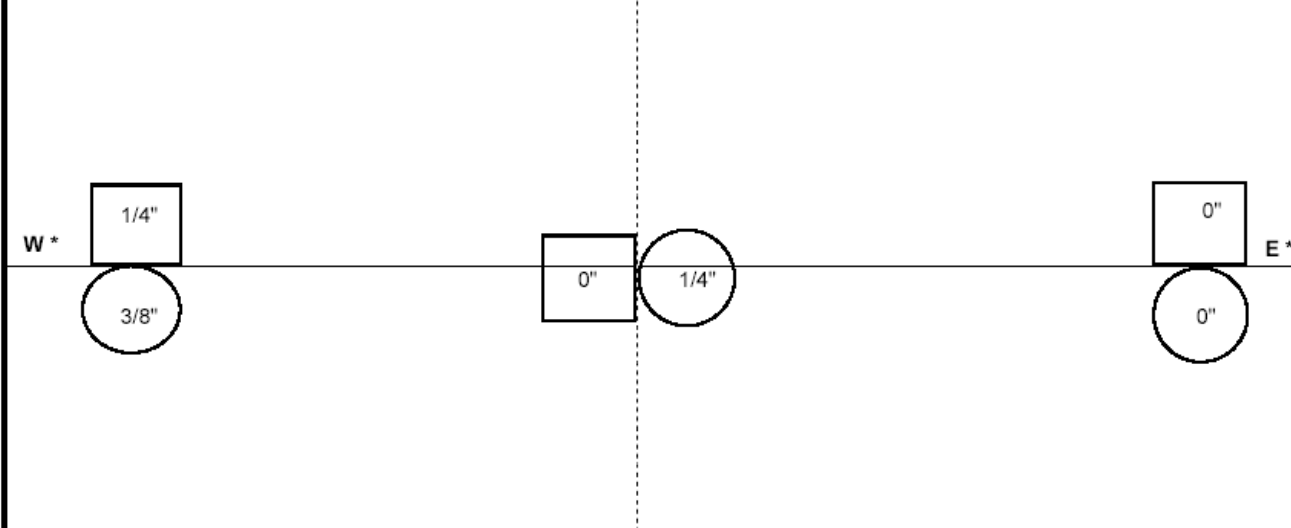

**Note: 50% of base shall have < 1/2 Inch of sediment.**  
**No area of shaft bottom shall be more than 1 1/2 Inches.**

Notes	Comments/Recommendations
60% area < 1/2", first test okay.	Rebar cage placed & concrete ordered after first test.
<b>60% area &lt; 1/2", second test okay.</b>	Concrete placed after second test was okay.
	** - See note on Page 1.

Results:  Satisfactory DS Foreman John Q Doe

Unsatisfactory SCDOT Inspector Jane Smith Time 9:25 am Date 06/05/02

**NOTE: Specification Tolerances - Location Variance at Top = 3 inches Max. Vertical (Plumbness) = 1 inch per 4 Ft. Max.**



















DRILLED SHAFT CONCRETE VOLUMES LOG (REV 06-03-02)

Project Name _____	Page <u>6</u> of <u>6</u>	
File No. _____	Bent No. _____	
Contractor _____	Shaft No. _____	
Completed By Contractor <u>DS Foreman -</u>	Date <u> / /</u>	Station _____
Reviewed By SCDOT <u>Inspector -</u>	Date <u> / /</u>	Offset _____

Concreting Curve

Depth (ft)

Concrete Volume Placed (cy)

Volume Delivered	VD	_____ cy
Volume In Pump Truck + Lines	VPTL	_____ cy
Volume of CSL Tubes	VCSLT	_____ cy
Wastage	VW	_____ cy
Volume Placed		
= VD-VPTL-VCSLT-VW =	VP	_____ cy
Theoretical Volume	VTh	_____ cy
Over Pour (VP-VTh => 1.00)	OP	_____ cy





**DRILLED SHAFT CONCRETE VOLUMES LOG (REV 06-03-02)**  
**SAMPLE 1 Construction Casing**

Project Name	Replace Bridge over Cooper Creek along US-322	Page	6	of	6
File No.	4.995	Bent No.	3		
Contractor	Drilled Shaft, Inc.	Shaft No.	3		
Completed By Contractor	DS Foreman - John Q. Doe	Date	06/05/02	Station	508 + 36
Reviewed By SCDOT	Inspector - John Smith	Date	06/05/02	Offset	24 FT. Right

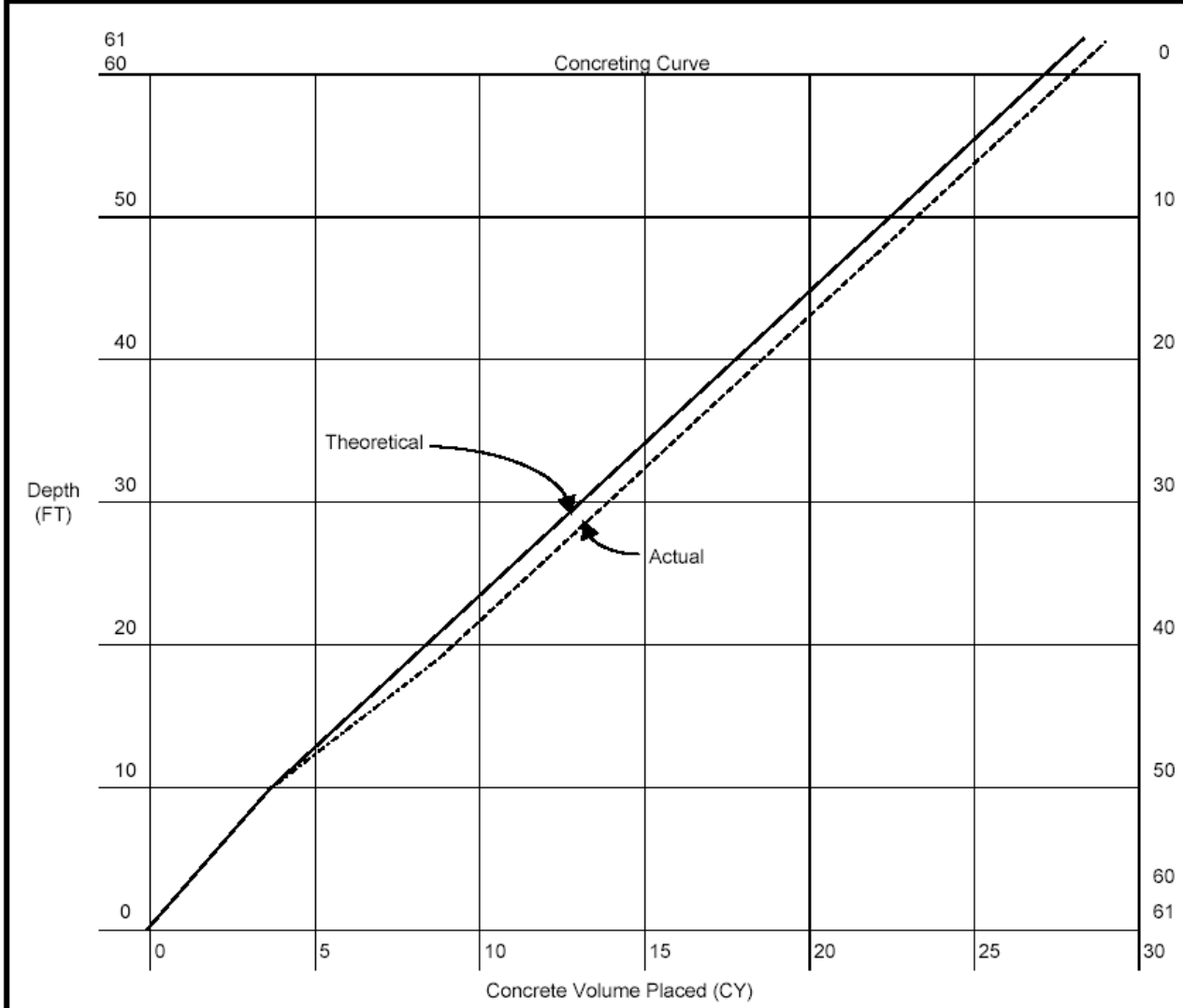

Volume Delivered	VD	31.0	CY
Volume In Pump Truck + Lines	VPTL	-1.4	CY - Volume left in pump truck and lines.
Volume of CSL Tubes	VCSLT	+0.2	CY
Wastage	VW	-2.0	CY - Removed pump lines and concrete overflow.
Volume Placed			
= VD-VPTL-VCSLT-VW =	VP	27.8	CY
Theoretical Volume	VTh	27.2	CY
Over Pour (VP-VTh => 1.00)	OP	0.6	CY
Under Pour (VP-VTh < 1.00)	UP	NA	CY



**DRILLED SHAFT CONCRETE VOLUMES LOG (REV 06-03-02)**  
**SAMPLE 2 Temporary Casing**

Project Name	Replace Bridge over Cooper Creek along US-322	Page	6	of	6
File No.	4.995	Bent No.	6		
Contractor	Drilled Shaft, Inc.	Shaft No.	3		
Completed By Contractor	DS Foreman - John Q. Doe	Date	06/05/02	Station	508 + 36
Reviewed By SCDOT	Inspector - Jane Smith	Date	06/05/02	Offset	24 FT. Right

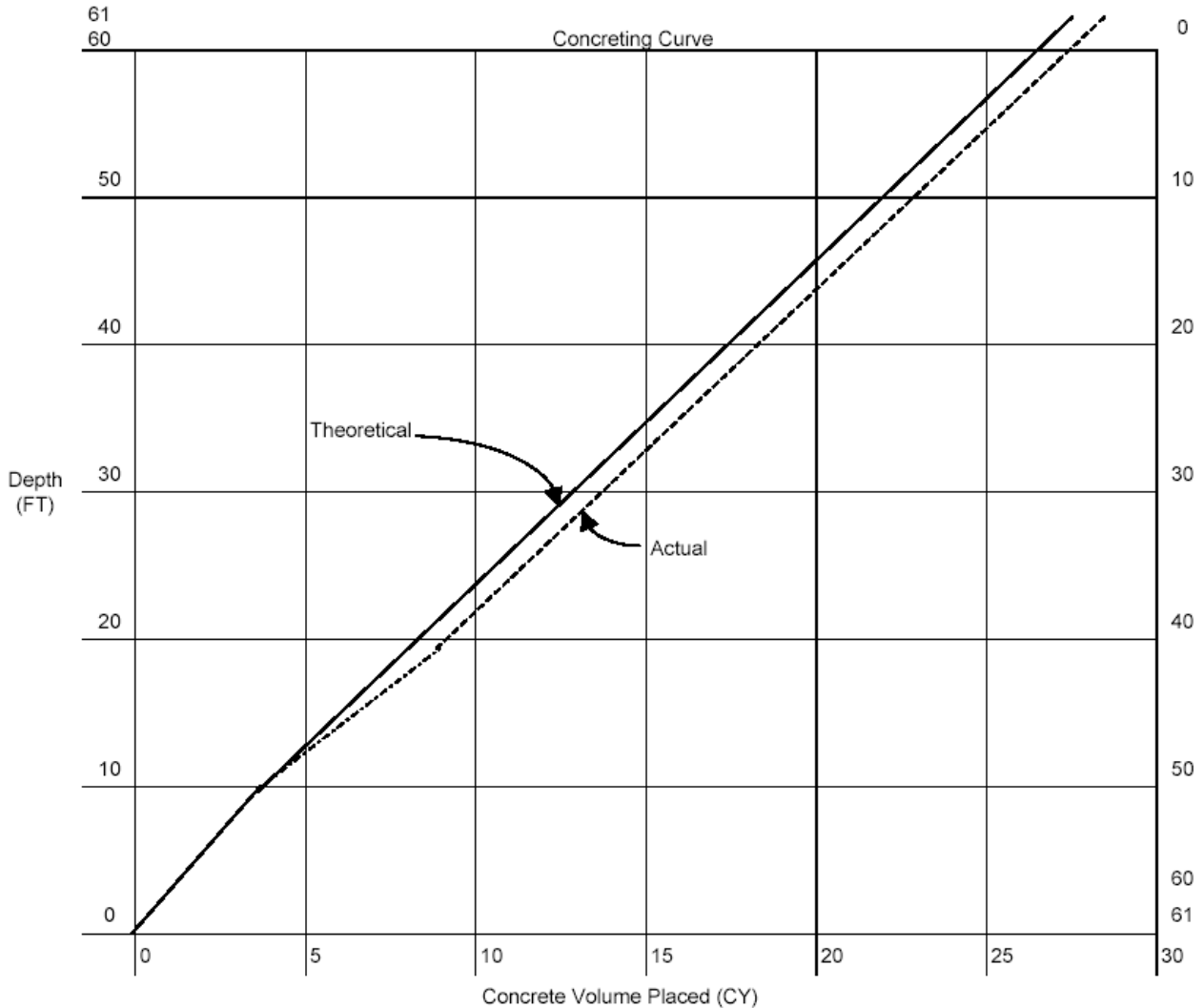

Volume Delivered	VD	31.0	CY
Volume In Pump Truck + Lines	VPTL	-1.4	CY - Volume left in pump truck and lines.
Volume of CSL Tubes	VCSLT	+0.2	CY
Wastage	VW	-2.0	CY - Removed pump lines and concrete overflow.
Volume Placed	VP	27.8	CY
= VD-VPTL-VCSLT-VW =			
Theoretical Volume	VTh	27.3	CY
Over Pour (VP-VTh $\geq$ 1.00)	OP	0.5	CY
Under Pour (VP-VTh < 1.00)	UP	NA	CY

# **EXHIBIT 7**

## **FEDERAL-AID PROJECT SUPPLEMENTAL SPECIFICATIONS**

**EXHIBIT 7**

**FEDERAL-AID SPECIFICATIONS AND FORMS**

**FOR**

**Replacement of US 701 Bridges over the Great Pee Dee River, Great Pee Dee  
Overflow, and Yauhannah Lake  
Georgetown/Horry Counties**

**TABLE OF CONTENTS**

<b>SUPPLEMENTAL SPECIFICATIONS.....</b>	<b>2</b>
APPLICATION OF DAVIS-BACON AND RELATED ACTS TO INDEPENDENT TRUCK DRIVERS AND MISCELLANEOUS CONSTRUCTION ACTIVITIES .....	2
REQUIREMENTS FOR FEDERAL AID CONTRACTS WHICH AFFECT SUBCONTRACTORS, DBE HAULERS, MATERIAL SUPPLIERS AND VENDORS .....	3
DISADVANTAGED BUSINESS ENTERPRISE (DBE).....	4
LATE DISCOVERY OF ARCHAEOLOGICAL/HISTORICAL REMAINS ON FEDERAL AID PROJECTS AND APPROVAL OF DESIGNATED BORROW PITS.....	17
SPECIFIC EQUAL EMPLOYMENT OPPORUNITY RESPONSIBILITIES TRAINING SPECIAL PROVISIONS.....	18
<b>REQUIRED CONTRACT PROVISIONS FEDERAL AID CONSTRUCTION CONTRACTS.....</b>	<b>20</b>
<b>STANDARD FEDERAL EQUAL EMPLOYMENT OPPORTUNITY CONSTRUCTION CONTRACT SPECIFICATIONS .....</b>	<b>31</b>
<b>GENERAL DECISION NUMBER: SC140041 01/03/2014 SC41.....</b>	<b>34</b>
<b>GENERAL DECISION NUMBER: SC140047 01/03/2014 SC47.....</b>	<b>38</b>
<b>DISADVANTAGED BUSINESS ENTERPRISES (DBE) COMMITTAL SHEET .....</b>	<b>42</b>

June 13, 1990

## **APPLICATION OF DAVIS-BACON AND RELATED ACTS TO INDEPENDENT TRUCK DRIVERS AND MISCELLANEOUS CONSTRUCTION ACTIVITIES**

### The Davis-Bacon and Related Acts apply when:

- 1) A Contractor or Subcontractor hires a trucking firm or fleet of trucks to haul materials from a plant, pit, or quarry, which has been established specifically to serve (or nearly so) a particular project or projects covered by Davis-Bacon and Related Acts.
- 2) A Contractor or Subcontractor hires a trucking firm or fleet of trucks to haul material from a non-commercial stockpile or non-commercial storage site outside the limits of the project to the project site.
- 3) A Contractor or Subcontractor hires a trucking firm or fleet of trucks to haul excavated materials away from a Davis-Bacon covered project.
- 4) A contractor or Subcontractor rents or leases equipment with an operator to perform work as called for under a Davis-Bacon construction contract.
- 5) A common carrier is used for the transportation of materials from an exclusive material supply facility to fulfill the specific need of a construction contract.

The fleet owner is not considered a Subcontractor with regard to the 70% subcontracting limitations and would not have to be approved as a Subcontractor. However, payrolls must be submitted by truck fleet owner covering the truck drivers, and all requirements such as predetermined wages, overtime, etc., are applicable. Legitimate owner-operators (truck owner driving his own truck) must appear on the payroll by name and notation "truck Owner Operator" with no hours, etc. shown.

### The Davis-Bacon and Related Acts do not apply when:

- 1) A Contractor or Subcontractor hires a trucking firm or fleet of trucks to haul materials from a commercial plant, pit, or quarry which had previously been established for commercial use and regularly sell materials to the general public.
- 2) A Contractor or Subcontractor hires a trucking firm or fleet of trucks to haul materials from an established commercial plant, pit, or quarry to a stockpile outside the limits of the project.
- 3) Bona fide owner-operators of trucks, who are independent contractors, use their own equipment to haul materials to or from or on a Davis-Bacon covered project. (One man-One truck)

The fleet owner is not considered a Subcontractor with regard to the 70% subcontracting limitation and would not have to be approved as a Subcontractor.

March 1, 2010

**REQUIREMENTS FOR FEDERAL AID CONTRACTS WHICH AFFECT SUBCONTRACTORS, DBE HAULERS, MATERIAL SUPPLIERS AND VENDORS**

- A. The contractor's attention is directed to the requirements of Section I.2 in Form FHWA 1273 that is included in your contract documents as the Supplemental Specification "Required Contract Provisions Federal-Aid Construction Contracts". Section I.2 requires that "the contractor shall insert in each subcontract all of the stipulations contained in the Required Contract Provisions". This requirement also applies to lower tier subcontractors or purchase orders. These provisions must be physically included in your subcontracts. A reference to the applicable specification will not suffice.
- B. The contractor's attention is directed to the requirements of the Supplemental Specification "Standard Federal Equal Employment Opportunity Construction Contract Specifications". Section 2 requires that the provisions of this specification must be physically included in each subcontract with a value of \$10,000 or greater.
- C. The contractor's attention is directed to the requirements of the Equal Employment Opportunity Performance certifications in the Proposal Form Certifications and Signatures section of the contract. Section 1 concerning Equal Employment Opportunity must be physically included in each subcontract.
- D. Prior to the issuance of formal approval, all DBE subcontracts must include a signed copy of the subcontract agreement between the Prime Contractor and the DBE Subcontractor.
- E. Prior to the issuance of formal approval, of any DBE haulers, the contractor must submit a signed copy of the hauling agreement.
- F. The contractor's attention is further directed that sections 1, 2, 3, 8, 9, and 11 of Form FHWA 1273, or Sections 1, 3, 8 and 10 of Form 1316 (for Appalachian contracts only) must be physically included in each purchase agreement with a value of \$10,000 or greater with a vendor or supplier, and in open-end contracts where individual purchases are less than \$10,000 but where the total purchases accumulate to \$100,000 or more per year.



May 2, 2014

## **DISADVANTAGED BUSINESS ENTERPRISE (DBE) SUPPLEMENTAL SPECIFICATION**

It is the policy of the South Carolina Department of Transportation (SCDOT) to ensure nondiscrimination in the award and administration of federally assisted contracts and to use Disadvantaged Business Enterprises (DBEs) in all types of contracting and procurement activities according to State and Federal laws. To that end the SCDOT has established a DBE program in accordance with regulations of the United States Department of Transportation (USDOT) found in 49 CFR Part 26.

This document, known as the "DBE Supplemental Specifications" includes two main parts:

- Part A. "Instructions to Bidders – Pre-award Requirements"
- Part B. "Instructions to Contractors – Post-award Requirements."

### **PART A. INSTRUCTIONS TO BIDDERS – PRE- AWARD REQUIREMENTS**

When incorporated into Design Build and/or Local Public Agency procurements, the terms "bid", "bidder", and "bid letting" shall mean "proposal", "proposer" and "proposal opening."

#### **1. DBE CONTRACT GOAL**

- A. The DBE participation goal for this contract is set forth in the DBE Special Provisions.
- B. The successful bidder shall exercise all necessary and reasonable steps to ensure that DBEs perform services or provide materials on this contract in an amount that meets or exceeds the DBE contract goal and commitment. Submitting the bid, including electronically, shall constitute an agreement by the bidder that if awarded the contract, it will meet or exceed the DBE contract goal and commitment or make good faith efforts to meet the goal or commitment. Failure to meet the contract goal or make good faith efforts to meet the contract goal will result in the the bid being considered irregular and subject to rejection in accordance with Section 102.8(1)(D) of the SCDOT Standard Specification for Highway Construction, resulting in the contract being awarded to the next lowest responsible and responsive bidder.

#### **2. DBE COMMITTAL**

A. Each bidder shall enter all the information regarding how it intends to meet the DBE goal in the electronic bid folder found on the electronic bidding service website, *Bid Express*, entitled "DBE List." (See paragraph (D) below for non-electronic bid submissions.) The listing of DBEs shall constitute a commitment by the bidder to utilize the listed DBEs, subject to the replacement requirement set forth below in Section 2 of Part B. A DBE listed on the DBE List or DBE Committal Sheet hereinafter shall be referred to as a "committed DBE."

B. In meeting the DBE contract goal, the bidder shall use only certified DBEs included in the "South Carolina Unified Certification Program DBE Directory" (hereinafter referred to as the "Unified DBE Directory.") The DBE.BIN file used for the electronic bidding contains the names of the certified DBEs in the " Unified DBE Directory." For more information on the use of the DBE.BIN file in electronic bidding, see Section 6 below.

C. Failure to provide all information required in the electronic bid or DBE Committal Sheet will make the bid irregular and subject to rejection, resulting in the contract being awarded to the next lowest responsible and responsive bidder.

D. The DBE.BIN file listed for the letting must be downloaded for each particular letting because it is the data source for the DBEs listed in the "Unified DBE Directory" designated for use in the letting. ALL DBE data such as Name, Company ID, and Address must be selected from drop-down lists provided by the DBE. BIN file. If the DBE.BIN file is not downloaded, no data for the drop-down lists will be available. For non-electronic bidding in Design/Build or Local Public Agency procurements, use the attached DBE Committal Sheet in lieu of the DBE.BIN file.

The following information must be selected or entered in the electronic bid:

- A. The names and addresses of certified DBEs whose services or materials will be used in the contract.
- B. Work Type and Work Code selected from a drop-down list. When one of these is selected, the other will be filled in automatically. **[Note: Only select the Work Type and Work Code for which the selected DBE firm has been certified to perform].**
- C. An Item of work, approximate Quantity of work to be performed or materials to be supplied, Unit (of measurement), Unit Price, and the extended dollar amount of participation by each DBE listed.
  - (a) Item: The Item is the bid item with which the DBE will be associated and must be selected from the Schedule of (Bid) Items found in the drop-down list. If the proposed work is for only a portion of an Item of work (i.e. hauling of materials, tying of reinforced steel, etc.) an adequate description of this work shall be included in the Note block.
  - (b) Quantity, Unit, & Unit Price: Initially when an Item is selected, the contract quantity, unit, and the bidder's unit price and extension will appear. If the proposed work is for only a portion of an item as described in (1) above, then the Quantity, Unit Price and /or Extension shall be changed to reflect the actual amount of work committed to the DBE. The Unit (of measurement) cannot be changed.
- (4) The bidder must also submit a copy of a signed statement or quote from each of the DBEs listed in the DBE List folder of the electronic bid or DBE committal sheet. The signed statements or quotes should verify the items, quantities, units, unit prices, and dollar values listed in the DBE List folder of the electronic bid or DBE committal sheet. **COPIES OF THE SIGNED STATEMENTS MUST BE SUBMITTED TO SCDOT CONTRACT ADMINISTRATION OFFICE WITHIN FOUR (4) BUSINESS DAYS OF THE BID LETTING** from the apparent low bidder. Should the apparent low bid be rejected for failing to meet the goal, the next apparent low bidder will have three (3) business days from notification to submit the signed quotes. SCDOT will accept facsimiles of the verified statements with the caveat that the bidder must furnish the original document to SCDOT upon request. Signed quotes must be on the DBEs letterhead and contain the following information: date, printed name, address, and phone number of the authorized individual providing the quote, project name and identification number, quote needs to be addressed to contractor from DBE, and identify specific services being performed and/or material being supplied.

### **3. GOOD FAITH EFFORTS REQUIREMENTS**

A. Requirements for Submission for Approval of a Good Faith Effort. If the bidder does not meet the DBE contract goal through the DBE committals submitted with the bid, it is the bidder's responsibility to request, in writing (faxes and emails are acceptable) a good faith effort review by 5:00 pm of the next business day after they submit their bid. Bidder must submit additional information to satisfy to SCDOT that good faith efforts have been made by the bidder in attempting to meet the DBE contract goal. **THIS SUPPORTING INFORMATION/DOCUMENTATION MUST BE FURNISHED TO SCDOT CONTRACT ADMINISTRATION OFFICE IN WRITING WITHIN THREE (3) BUSINESS DAYS OF THE BID LETTING.** One complete set and five (5) copies of this information must be received by Contract Administration no later than 12:00 noon of the third business day following the bid letting. Where the information submitted includes repetitious solicitation letters, it will be acceptable to submit a sample representative letter along with the list of the firms being solicited. The documented efforts listed in item (C.) below are some of items SCDOT will consider in evaluating the bidder's good faith efforts. The documentation may include written subcontractor quotations, telephone log notations of verbal quotations, or other types of quotation documents.

B. Failure to Submit Required Material. If the bidder fails to provide this information by the deadline, the bid is considered irregular and may be rejected in accordance with Section 102.8(1)(D), SCDOT Standard Specifications for Highway Construction.

C. Evaluation of a Good Faith Effort. SCDOT may consider the following factors in judging whether or not the bidder made adequate and acceptable good faith efforts to meet the DBE contract goal:

- (1) Did the bidder attend any pre-bid meetings that were scheduled by SCDOT or Local Public Agency to inform DBEs of subcontracting opportunities?
- (2) Did the bidder provide solicitations through all reasonable and available means (e.g. posting a request for quotes from DBE subcontractors on SCDOT Construction Extranet webpage; attendance at pre-bid meetings, advertising and/or written notices at least 10 days prior to the letting; or showing the bidder provided written notice to all DBEs listed in the "Unified DBE Directory" that specialize in the areas of work in which the bidder will be subcontracting).
- (3) Did the bidder follow-up initial solicitations of interest by contacting DBEs to determine with certainty whether they were interested or not? If a reasonable amount of DBEs in the area of work do not provide an intent to quote, or there are no DBEs that specialize in the area of work to be subcontracted, did the bidder call SCDOT Office of Business Development & Special Programs to give notification of the bidder's inability to obtain DBE quotes?
- (4) Did the bidder select portions of the work to be performed by DBEs in order to increase the likelihood of meeting the contract goal? This includes, where appropriate, breaking out contract items of work into economically feasible units to facilitate DBE participation, even when the bidder might otherwise perform these items of work with its own forces.
- (5) Did the bidder provide interested DBEs with adequate and timely information about the plans, specifications, and requirements of the contract?
- (6) Did the bidder negotiate in good faith with interested DBEs, or reject them as unqualified without sound reasons based on a thorough investigation of their capabilities? Any rejection should be noted in writing with a description as to why an agreement could not be reached. The fact that the bidder has the ability or desire to perform the work with its own forces will not be considered as sound reason for rejecting a DBEs quote.
- (7) Was a quote received from an interested DBE, but rejected as unacceptable because it was not the lowest quote received? The fact that the DBE firm's quotation for the work is not the lowest quotation received will not in and of itself be considered as a sound reason for rejecting the quotation as unacceptable, as long as the quote is not unreasonable.
- (8) Did the bidder specifically negotiate with non-DBE subcontractors to assume part of the responsibility to meet the contract goal when the work to be sublet includes potential for DBE participation?
- (9) Any other evidence that the bidder submits which demonstrates that the bidder has made reasonable good faith efforts to include DBE participation.
- (10) The DBE commitments submitted by all other bidders who were able to meet the DBE contract goal.
- (11) Did the bidder contact SCDOT for assistance in locating certified DBEs?

D. Nothing in this provision shall be construed to require the bidder to accept unreasonable quotes in order to satisfy DBE contract goals.

E. SCDOT may give the bidder an opportunity to cure any deficiencies resulting from a minor informality or irregularity in the DBE commitment or waive any such deficiency when it is in the best interest of the State. A minor informality or irregularity is one which is merely a matter of form or is some immaterial variation from the exact requirements of the invitation for bids having no effect or merely a trivial or negligible effect on DBE contract goal, quality, quantity, or delivery of the supplies or performance of the contract, and the correct or waiver of which would not be prejudicial to bidders.

#### **4. DETERMINATION AND RECONSIDERATION PROCEDURES**

A. After the letting, SCDOT will determine whether or not the low bidder has met the DBE participation contract goal or made good faith efforts to meet the goal. If SCDOT determines that the apparent low bidder failed to meet the goal, did not demonstrate a good faith effort to meet the goal, or meet the requirements of a commercially useful function SCDOT will notify the apparent low bidder of its determination by email and by US Mail or hand-delivery. The apparent low bidder may request a reconsideration of this determination.

B. The bidder must make a request for reconsideration in writing within three (3) business days of receipt of the determination. Within six (6) business days of receipt of the determination, the bidder must provide written documentation to SCDOT Director of Construction supporting its position. Only documentation dated within three (3) business days of the bid letting may be used in support of its position. No DBE goal efforts performed after 3 business days of the bid will be allowed as evidence. If the bidder fails to request a reconsideration with three (3) business days, the determination shall be final.

C. To reconsider the bidder's DBE commitment or good faith efforts, the Deputy Secretary for Engineering will designate a panel of three (3) SCDOT employees, who did not take part in the original determination, comprised of: (1) one employee from the District Construction Engineer's (DCE) Office, (2) one employee from the Office of Business Development & Special Programs, and (3) one employee at large (hereinafter referred to as the "Reconsideration Panel"). The DCE Office representative will be appointed chairman of the Reconsideration Panel. A representative from FHWA may be a non-voting member of the Reconsideration Panel. The Reconsideration Panel will contact the bidder and schedule a meeting. The Reconsideration Panel will make reasonable efforts to accommodate the bidder's schedule; however, if the bidder is unavailable or not prepared for a hearing within ten (10) business days of receipt of SCDOT original written determination, the bidder's reconsideration rights will be considered to have been waived.

D. The meeting will be held at SCDOT Headquarters Building, 955 Park Street, Columbia, South Carolina. The bidder will be allowed up to two (2) hours to present written or oral evidence supporting its position.

E. The Reconsideration Panel will issue a written report and recommendation to the Deputy Secretary for Engineering. SCDOT shall not award the contract until the Deputy Secretary for Engineering issues a decision or the bidder waives its reconsideration right either through failure to request reconsideration or failure to be available for the meeting. The Deputy Secretary for Engineering will notify the bidder of the final decision in writing.

## **5. CONSEQUENCES OF FAILURE TO COMPLY WITH DBE PROVISIONS**

A. Failure on the part of the bidder to meet the DBE contract goal or to demonstrate good faith efforts to meet the DBE contract goal will result in the bid being declared irregular and may be rejected resulting in the contract being awarded to the next lowest responsible and responsive bidder. Upon rejection, the award may be made to the next lowest responsible and responsive bidder.

B. After bid letting, but prior to award, SCDOT reserves the right to cancel the project, or any or all bids or proposals may be rejected in whole or part, when it is in the best interest of the State.

## **6. DIRECTORY OF SOUTH CAROLINA CERTIFIED DISADVANTAGED BUSINESS ENTERPRISES**

A. The electronic DBE.BIN file found on the electronic bidding service website, *Bid Express*, contains data from the "Unified DBE Directory" approved for use in each particular letting. **The file must be downloaded for each letting because the directory approved for use in each letting is updated prior to the letting.** The bidder is advised that this directory pertains only to DBE certification and not to qualifications. It is the bidder's responsibility to determine the actual capabilities and/or limitations of the certified DBE firms. For non-electronic bid submissions, the directory can be found at [http://www.scdot.org/doing/businessDevelop\\_SCUnified.aspx](http://www.scdot.org/doing/businessDevelop_SCUnified.aspx).

B. In meeting the DBE participation contract goal, the bidder shall use only DBEs that are included in the "Unified DBE Directory" contained in the DBE.BIN file, or on-line, current for the month the bid is submitted. The bidder may only count toward the DBE goal work in the areas for which the DBE has been certified, unless prior written approval from SCDOT is obtained. The bidder and the DBE must jointly apply to SCDOT's Director of Construction for approval of work in an area of work other than that in which the DBE has been certified. The requested work must be in an area related to the area of work in which the DBE has been certified. Such requests must be submitted in writing to the Director of Construction no later than ten (10) business days prior to the date of the letting. The Director of Construction has the right to approve or disapprove the request. The Director of Construction will give the bidder and the DBE written notice of his decision no later than five (5) business days prior to the date on which bids are received. If approved, a copy of the written approval must accompany the submission of the subcontractor's quote.

C. Certification of a DBE for work in a certain area of work or approval to perform work in a related area shall not constitute a guarantee that the DBE will successfully perform the work or that the work will be performed completely. Such certification or approval shall only imply that the successful completion of the work by the DBE can count toward satisfying the DBE contract goal in accordance with the counting rules set forth in 49 CFR Part 26 (see Section 3 of Part B below.)

D. The bidder may print a copy of the "Unified DBE Directory" from SCDOT web page at [http://www.scdot.org/doing/businessDevelop\\_SCUnified.aspx](http://www.scdot.org/doing/businessDevelop_SCUnified.aspx).

## **7. ADDITIONAL DBE PARTICIPATION**

The bidder is strongly encouraged to obtain the maximum amount of DBE participation feasible on the contract. Any DBE participation in excess of the DBE contract goal shall also be included in the DBE Quarterly Reports.

## **8. CONTRACTOR'S RESPONSIBILITY TO REPORT BIDDER INFORMATION**

The bidder should keep a list of all subcontractors (DBE or non-DBE) who bid or quoted for subcontracts on this project. As a condition to prequalification or renewal of prequalification, Contractors must submit the names and addresses of all firms (DBE and non-DBE) who quoted the Contractor for subcontracts on SCDOT projects throughout the course of the previous year.

## **Part B. INSTRUCTIONS TO CONTRACTORS – POST AWAD REQUIREMENTS**

### **1. CONTRACTOR'S OBLIGATIONS**

A. 49 CFR 26. The Contractor shall carry out the applicable requirements of 49 CFR Part 26 and these DBE Supplemental Specifications in the award and administration of this contract. Failure by the Contractor to carry out these requirements is a material breach of the contract, and may result in the termination of the contract or such other remedy as SCDOT deems appropriate.

B. Meeting both the Goal and Commitment or Making Good Faith Efforts to Meet the Goal and Commitment. It is the Contractor's responsibility to meet or make good faith efforts to meet the DBE contract goal and commitments. Failure to meet the goal or commitments to the specific DBEs listed on the committal sheet or to demonstrate good faith efforts to meet the goal or commitments may result in any one or more of the following sanctions:

- (1) Withholding monthly progress payments;
- (2) Declaring the Contractor in default pursuant to Section 108.10 of the Standard Specifications and terminating the contract;
- (3) Assessing sanctions in the amount of the difference in the DBE contract committal and the actual payments made to each certified DBEs;
- (4) Disqualifying the Contractor from bidding pursuant to Regulation 63-306, Volume 25A, of the S. C. Code of Laws; and/or
- (5) Requiring the Contractor to obtain DBE participation on future contracts to the extent the Contractor failed to meet or use good faith efforts to meet the DBE contract goal.

C. Using the DBEs shown on the Committal Sheet to Perform the Work. The Contractor must utilize the specific DBEs listed on the "DBE Committal Sheet" to perform the work and supply the materials for which each is listed unless the Contractor obtains prior written approval from the Director of Construction to perform the work with other forces or obtain the materials from other sources as set forth in Section 2 below. The Contractor shall not be entitled to any payment for such work or material unless it is performed or supplied by the listed DBE or, with prior written approval of the Director of Construction, by other forces (including those of the Contractor). Failure to meet a commitment to a specific DBE may result in the sanctions listed in Section 1(B) above, unless prior written approval is obtained for replacement of the committed DBE.

When SCDOT makes changes that result in the reduction or elimination of work to be performed by a committed DBE, the Contractor will not be required to seek additional participation. When the SCDOT makes changes that result in additional work to be performed by a DBE based upon the Contractor's commitment, the DBE shall participate in additional work to the same extent as the DBE participated in the original work.

D. Incorporating DBE Supplemental Provisions in Subcontracts. The Contractor shall make available, at the request of SCDOT, a copy of all DBE subcontracts. The Contractor shall ensure that all subcontracts or agreements with DBEs to supply labor or materials require that the subcontract and all lower tier subcontracts be performed in accordance with these DBE Supplemental Specifications. The contractor is advised to insert the following provision in each subcontract or agreement:

"This contract or agreement shall be performed in accordance with the requirements of the SCDOT DBE Supplemental Specifications dated January 1, 2014."

## 2. REPLACEMENT OF CERTIFIED DBES

A. Requirement for Replacement. The following shall apply to replacement of a DBE listed on the "DBE Committal Sheet":

- (1) *When a DBE listed on the DBE committal sheet (hereafter referred to as a "committed DBE") is unable or unwilling to perform the work in accordance with the subcontract, the Contractor shall follow the replacement procedures in Section 2(B) below. Failure on the part of the Contractor to comply with this requirement shall constitute a breach of contract and may be cause for the imposition of the sanctions set forth in Section 1(B) above.*
- (2) *When a committed or non-committed DBE is decertified or removed from the SC Unified DBE Directory after execution of a valid subcontract agreement with the Contractor.*
  - (a) The Contractor may continue to utilize the decertified DBE on the contract and receive credit toward the DBE contract goal for the DBEs work unless the Contractor is implicated in the DBE decertification. However, the Contractor is encouraged to replace the decertified DBE with a certified DBE where feasible, to assist SCDOT in meeting the overall statewide DBE goal.
  - (b) If a *committed or non-committed* DBE is removed from the SC Unified DBE Directory due to graduation from the DBE program, the Contractor may continue to utilize the graduated DBE on the contract and receive credit toward the DBE contract goal for the DBEs work.
- (3) *When a committed DBE is decertified or removed from the SC Unified DBE Directory prior to execution of a valid subcontract agreement with the Contractor, the Contractor shall follow the replacement procedures in Section 2(B) below. Failure on the part of the Contractor to comply with this requirement shall constitute a breach of the contract and may be cause for the imposition of the sanctions set forth in Section 1(B) above.*

B. Replacement Procedures. In order to replace a *committed* DBE, the Contractor must obtain prior written approval from the Director of Construction. Prior to requesting SCDOT's approval to terminate and/or substitute a committed DBE, the Contractor is to give notice to the DBE subcontractor in writing (certified mail) with a copy provided to both the Director of Construction and the Director of Business Development & Special Programs. The purpose of this notice is to both inform the DBE subcontractor of the Contractor's intent to request SCDOT's approval to terminate and/or substitute as well as to outline the reasons for the request. The DBE subcontractor shall be given five business days from receipt of notice to provide a written response stating either its consent or its reasons why it objects to the proposed termination. On a case by case basis and at SCDOT's sole discretion, a shorter response period than five business days may be allowed as a matter of public necessity. If SCDOT determines a shorter response period is justified, the contractor and committed DBE will be advised in writing. In no case shall the Contractor's ability to negotiate a more advantageous contract with another subcontractor be considered a valid basis for replacement. If the Contractor obtains the Director of Construction's approval for the replacement, the Contractor shall replace the committed DBE with another certified DBE or make good faith efforts to do so as set forth in Section 2(C) below. Any DBE who is certified at the time of replacement may be used as a replacement. If the Director of Construction does not approve of replacement, the Contractor shall continue to use the *committed* DBE in accordance with the contract. Failure to do so may constitute cause for imposition of any of the sanctions set forth in Section 1(B) above.

C. Good Faith Efforts. After approval for replacement is obtained, if the Contractor is not able to find a replacement DBE, the Contractor shall provide the Director of Construction with documentation of its good faith efforts to find a replacement. This documentation shall include, but is not limited to, the following:

- (1) Copies of written notification to certified DBEs that their interest is solicited in subcontracting the work defaulted by the previous certified DBE or in subcontracting other items of work in the contract.
- (2) Statement of efforts to negotiate with certified DBEs for specific subbids including at a minimum:
  - (a) Names, addresses and telephone numbers of certified DBEs who were contacted;
  - (b) Description of the information provided to certified DBEs regarding the plans and specifications for portions of the work to be performed;
  - (c) Statement of why additional agreements with certified DBEs were not reached.
- (3) For each certified DBE contacted but rejected, the reasons for the Contractor's rejection. Failure to find a replacement DBE at the original price is not in itself evidence of good faith.
- (4) Documentation demonstrating that the Contractor contacted SCDOT's DBE Supportive Service Office for assistance in locating certified DBEs willing to take over that portion of work or do other work on the contract.

If SCDOT determines that the Contractor has made good faith efforts to replace the committed DBE with another certified DBE, then the remaining portion of the DBEs work shown on the "DBE Committal Sheet" can be completed by the Contractor's own forces or by a non-DBE subcontractor approved by SCDOT. The Contractor will not be required to make up that part of the DBE goal attributable to the portion of work not completed by the committed DBE, and this shortfall in meeting the DBE goal will be waived by SCDOT.

If SCDOT determines that the Contractor has not made good faith efforts to replace the committed DBE with another certified DBE, such failure may constitute cause for imposition of any of the sanctions set forth in Section 1(B) above.

D. Payment from SCDOT. The Contractor shall not be entitled to payment for work or material committed to a committed DBE unless:

- (1) The work is performed by the *committed* DBE; or
- (2) The work is performed by another certified DBE after the Director of Construction has given approval to replace the committed DBE as provided above; or
- (3) The work is performed by a non-DBE after SCDOT determines that the Contractor has demonstrated good faith efforts to replace the committed DBE as provided above.

### 3. COUNTING CERTIFIED DBE PARTICIPATION TOWARD MEETING THE DBE GOAL

DBE participation shall be measured by the actual, verified payments made to DBEs subject to the following rules (all references to "DBE" herein shall mean "certified DBE"). The Contractor is bound by these rules in regard to receiving and reporting credit toward the DBE contract goal. The Contractor shall report on DBE Quarterly Reports only the amounts properly attributable toward the goal under these rules.



A. General Counting Rules.

- (1) The entire amount of that portion of a construction contract (or other contract not covered by paragraph A(2) of this section) that is performed by the DBE's own forces may be counted toward the goal. The cost of supplies and materials obtained by the DBE for the work of the contract, including supplies purchased or equipment leased by the DBE (except supplies and equipment the DBE subcontractor purchases or leases from the prime contractor or its affiliate) can be counted toward the goal.
- (2) When a DBE subcontracts part of the work of its contract to another firm, the value of the subcontracted work may be counted toward DBE goals only if the subcontractor is also a DBE. Work that a DBE subcontracts to a non-DBE firm does not count toward the DBE goals.
- (3) The Contractor can count expenditures to a DBE only if the DBE is certified by SCDOT, except as provided in section 2(A)(2) above, in the event a DBE loses eligibility status after a subcontract is signed.
- (4) The Contractor can count expenditures to a DBE only after the DBE has actually been paid.

B. Joint Ventures. When a DBE performs as a participant in a joint venture, the portion of the total dollar value of the contract equal to the distinct, clearly defined portion of the work of the contract that the DBE performs with its own forces can be counted toward DBE goals. A joint venture must be approved by the Director of Construction prior to start of the contract.

C. Commercially Useful Function. Expenditures to a DBE contractor can be counted toward DBE goals only if the DBE is performing a commercially useful function on that contract:

- (1) A DBE performs a commercially useful function when it is responsible for execution of the work of the contract and is carrying out its responsibilities by actually performing, managing, and supervising the work involved. To perform a commercially useful function, the DBE must also be responsible, with respect to materials and supplies used on the contract, for negotiating price, determining quality and quantity, ordering the material, and installing (where applicable) and paying for the material itself. To determine whether a DBE is performing a commercially useful function, SCDOT will evaluate the amount of work subcontracted, industry practices, whether the amount the firm is to be paid under the contract is commensurate with the work it is actually performing and the DBE credit claimed for its performance of the work, and other relevant factors.
- (2) A DBE does not perform a commercially useful function if its role is limited to that of an extra participant in a transaction, contract, or project through which funds are passed in order to obtain the appearance of DBE participation. In determining whether a DBE is such an extra participant, SCDOT will examine similar transactions, particularly those in which DBEs do not participate.
- (3) If a DBE does not perform or exercise responsibility for at least 30 percent of the total cost of its contract with its own work force, or the DBE subcontracts a greater portion of the work of a contract than would be expected on the basis of normal industry practice for the type of work involved, SCDOT will presume that it is not performing a commercially useful function.
- (4) When a DBE is presumed not to be performing a commercially useful function as provided in paragraph (3) of this section, the DBE may present evidence to rebut this presumption. SCDOT may determine that the firm is performing a commercially useful function given the type of work involved and normal industry practices.
- (5) SCDOT's decisions on commercially useful function matters are subject to review by the Federal Highway Administration, but are not administratively appealable to the USDOT.

D. Special Rules for Trucking Companies. SCDOT will use the following rules to determine whether a DBE trucking company is performing a commercially useful function and what portion of the DBE work can be counted toward DBE goals:

- (1) **DBE must control all work.** To be considered as performing a commercially useful function, the DBE must be responsible for the management and supervision of the entire trucking operation for which it is responsible on a particular contract, and there cannot be a contrived arrangement for the purpose of meeting DBE goals.
- (2) **DBE must “own” at least one truck.** The DBE must itself own and operate at least one fully licensed, insured, and operational truck used on the project. For purposes of this section, a DBE will be considered to “own” a truck if:
  - a) the truck is titled in the DBE’s name; or,
  - b) the DBE leases the truck under a valid lease-to-own agreement and the driver of the truck is an employee of the DBE.The DBE must submit documentation to SCDOT to establish the number of trucks the DBE owns, operates and insures. The DBE must submit the documentation to SCDOT’s Office of Business Development & Special Programs at the time of certification, annual reporting on certification requirements, or at any time during the year that the DBE obtains additional trucks.
- (3) **Counting DBE trucking toward DBE goal.** The Contractor can count toward DBE goals the total value of the transportation services the DBE provides using trucks the DBE owns, insures, and operates using drivers the DBE employs.
- (4) **Counting subcontracted DBE trucking toward DBE goal.** The DBE may subcontract with another DBE firm, including an owner-operator who is certified as a DBE, to provide trucks on a project. In this case, the Contractor may count toward the DBE goal the total value of the transportation services provided by the DBE subcontractor.
- (5) **Counting subcontracted non-DBE trucking toward the goal.** The DBE may lease trucks from a non-DBE firm, including an owner-operator, to provide trucks on a project. Prior to beginning work, the DBE must provide SCDOT’s Resident Construction Engineer with a list identifying all DBE and non-DBE trucks and truck numbers that will be used on the project. In this case, the Contractor may count toward the DBE goal the total value of the transportation services provided in each quarter by the non-DBE trucks, not to exceed the value of the transportation services provided by DBE-owned trucks in that quarter. For example, in a given quarter, if DBE-owned trucks provide transportation services of \$50,000, while non-DBE trucks provide transportation services of \$75,000, a maximum of \$100,000 can be counted toward the DBE goal in that quarter.

For purposes of this paragraph (5), a lease must indicate that the DBE has exclusive use of and control over the truck. This does not preclude the leased truck from working for others during the term of the lease with the consent of the DBE, so long as the lease gives the DBE absolute priority for use of the lease truck. Leased trucks must display a placard with the name and USDOT identification number of the DBE leasing the truck. The placard must be legible and visible when standing at least 15 feet from the driver’s side of the truck. It may be affixed to the side of the truck or inside the cab window as long as it does not interfere with the safe operation of the truck. See example below.

Sample placard:

<p>Operated by:</p> <p>Bell’s Trucking,LLC USDOT 123456</p>
---

**NOTE: DBE firms may not receive credit for DBE participation when leasing non-DBE owned trucks from the Prime contractor with whom the DBE firm is subcontracted as 49 CFR 26.55(a)(1) applies.**

E. DBE Manufacturers and Dealers. The Contractor can count expenditures with DBEs for materials or supplies toward DBE goals in accordance with the following rules:

- (1) *DBE Manufacturers.* If the materials or supplies are obtained from a DBE manufacturer, the Contractor can count 100 percent of the cost of the materials or supplies toward DBE goals. For purposes of this paragraph, a manufacturer is a firm that operates or maintains a factory or establishment that produces, on the premises, the materials, supplies, articles, or equipment required under the contract and of the general character described by the specifications. The DBE must be listed as a “manufacturer” in the "South Carolina Unified DBE Directory” to be considered a manufacturer for purposes of these counting rules.
- (2) *DBE Dealers.* If the materials or supplies are purchased from a DBE regular dealer, the Contractor can count 60 percent of the cost of the materials or supplies toward DBE goals. For purposes of this section, a regular dealer is a firm that owns, operates, or maintains a store, warehouse, or other establishment in which the materials, supplies, articles or equipment of the general character described by the specifications and required under the contract are bought, kept in stock, and regularly sold or leased to the public in the usual course of business. The DBE must be listed as a “dealer” in the South Carolina Unified DBE Directory to be considered a dealer for purposes of these counting rules.
- (3) *DBE Brokers.* With respect to materials or supplies purchased from a DBE which is neither a manufacturer nor a regular dealer, count the entire amount of fees or commissions charged for assistance in the procurement of the materials and supplies, or fees or transportation charges for the delivery of material or supplies required on a job site, toward DBE goals.

F. Special Rules for Design Build and Local Public Agency Contracts

- (1) When the Design Build team changes work that results in the reduction or elimination of work that the Design Build team committed to be performed by a DBE, the Design Build team shall seek additional participation by DBEs equal to the reduced DBE participation cause by the change.

#### 4. JOINT CHECKS.

The Director of Construction must approve all requests for a Contractor to issue and use joint checks with a DBE. The following conditions apply:

- a) The DBE must submit a request to the Director of Construction which includes a formalized agreement between all parties that specify the conditions under which the arrangement will be permitted;
- b) The DBE remains responsible for all other elements of 49 CFR 26.55(c)(1). SCDOT must clearly determine that independence is not threatened because the DBE retains final decision making responsibility;
- c) There can be no requirement by the prime contractor that a DBE use a specific supplier nor the prime contractor's negotiated unit price.

## 5. **REPORTS**

The Contractor shall furnish to the SCDOT the following reports and information. THIS REQUIREMENT APPLIES REGARDLESS OF WHETHER THERE IS A CONTRACT GOAL ASSIGNED TO THE CONTRACT.

A. **DBE Quarterly Reports.** The Contractor shall provide to the SCDOT, DBE Quarterly Reports showing the dollar amount of payments to each certified DBE. The Contractor and each DBE that received payment must sign the report. The Contractor's and DBE's signature on the Quarterly Report shall constitute certification that the DBE has performed the work and that the Contractor is entitled to credit toward the DBE goal for the amount shown in accordance with the counting rules set forth in Section 3 above. The report shall include the amount paid each DBE for the quarter and the total amount paid to each DBE on the contract. The report must include DBE subcontractors, hauling firms, and suppliers. The report shall be submitted in duplicate to the Resident Construction Engineer by the 15th of the month after each calendar quarter (January, April, July, and October 15). Failure to submit the quarterly report may result in the withholding of monthly progress and/or final payment. The Quarterly Report must be submitted for each quarter even if no payments have been made to a DBE in that quarter. When no payments have been made to a DBE in a quarter, DBEs are not required to sign the report.

B. **Trucker's Reports.** All DBE haulers must complete and submit a DBE Trucker's Report along with the DBE quarterly report when the DBE leases trucks from another firm. The DBE hauler must list all trucks leased, payments made to the lessee during the quarter, and identify whether each leased truck is owned by a certified DBE or non-DBE. DBE Haulers must also submit one copy of each lease agreement to the Resident Construction Engineer prior to the start of work for each truck leased. A lease must indicate that the DBE has exclusive use of and control over the truck. This does not preclude the leased truck from working for others during the term of the lease with the consent of the DBE, so long as the lease gives the DBE absolute priority for use of the leased truck. Leased trucks must display the name and identification number of the DBE.

C. **Other Documents.** Upon request of SCDOT, the Contractor and all subcontractors shall furnish documents, including subcontracts, necessary to verify the amount and costs of the materials or services provided by certified DBE suppliers or subcontractors. The Contractor shall keep the documents that verify this information for at least three years from the date of final close-out of the contract. Failure to provide these documents upon request may result in the withholding of monthly progress and/or final payment or disqualifying the Contractor from bidding pursuant to R. 63-306, South Carolina State Regulations.

## 6. **CONTRACT COMPLETION – DETERMINATION OF WHETHER CONTRACTOR HAS MET THE GOAL OR MADE GOOD FAITH EFFORTS**

A. **Review by SCDOT.** After receipt of the final DBE Quarterly Reports, SCDOT will review the necessary contract documentation to determine whether the Contractor has met the DBE commitments and contract goal.

B. **Notification of Failure to Meet Goal.** If the documentation indicates that the Contractor has not met the DBE commitments and contract goal, the Director of Construction will notify the Contractor in writing and request documentation of the Contractor's good faith efforts to meet the goal.

C. **Determination of Good Faith Efforts.** The Contractor shall submit documentation demonstrating good faith efforts to meet the contract commitments and goal to the Director of Construction within thirty (30) days of the date of the "Notification of Failure to Meet Goal." The Director of Construction will provide the Contractor with written notice of SCDOT's determination whether good faith efforts have been demonstrated.

D. Request for Reconsideration. If the Contractor disagrees with SCDOT's determination of post construction compliance, the Contractor may request a reconsideration by filing a written request with the Director of Construction within ten (10) business days after receipt of the determination. The Contractor shall submit any additional documentation that it wishes to be considered in support of its position within ten (10) business days of its request for reconsideration. If the Contractor fails to request a reconsideration within ten (10) days, the determination shall be final. If the Contractor requests reconsideration, the Director of Construction Office will appoint a Reconsideration Official who did not take part in the original determination to review the decision and supporting documentation (hereinafter referred to as the "Reconsideration Official"). FHWA may participate in the review process. The Reconsideration Official will contact the Contractor and schedule a meeting with the Contractor. The meeting will be held at the SCDOT Headquarters Building in Columbia. At the meeting, the Contractor will have an opportunity to present oral and written evidence to demonstrate that good faith efforts were made to meet the DBE commitments and contract goal. The Reconsideration Official may also consider evidence presented by SCDOT at the same meeting. After the meeting, the Reconsideration Official will issue a written report and recommendation to the Director of Construction. The Director of Construction shall make the final decision on the issue. The Director of Construction will notify the Contractor of the final decision in writing.

August 7, 1991

## **LATE DISCOVERY OF ARCHAEOLOGICAL/HISTORICAL REMAINS ON FEDERAL AID PROJECTS AND APPROVAL OF DESIGNATED BORROW PITS**

### A. Late Discovery of Archaeological/Historical Remains on Federal Aid Projects.

#### 1. Responsibilities:

The Contractor and subcontractors must notify their workers to watch for the presence of any prehistoric or historic remains, including but not limited to arrowheads, pottery, ceramics, flakes, bones, graves, gravestones, or brick concentrations. If any such cultural remains are encountered, the Resident Construction Engineer shall be immediately notified and all work in the vicinity of the discovered materials or site shall cease until the Department's Staff Archaeologist or the State Highway Engineer directs otherwise.

#### 2. Applicability:

This provision covers all areas of ground disturbance resulting from this federal - aid contract, including but not limited to road construction, Department designated borrow pits, Contractor furnished borrow pits, and/or staging areas.

#### 3. Cost Reimbursement and Time Delays:

Any extra work required by A(1) above within the project right of way or on Department designated borrow pits (see below) will be paid for in accordance with Subsection 104.05 of the Standard Specifications. Extra contract time may be provided under Subsection 108.06 of the Standard Specifications for archaeological work within the project right of way or on designated borrow pits.

**NOTE:** On Contractor furnished borrow pits the contractor is not entitled to any additional time or money for delay on impact resulting from A(1) above or for extra work required by A(1) above. Therefore, contractors may wish to retain professional archaeological services to better ensure that borrow pit areas are cleared of archaeological/historical remains prior to use on Federal aid projects.

### B. Approval of Designated Borrow Pits on Federal Aid Projects (Plant Sites which qualify as commercial are not included).

In instances where the Department specifically designates the location of borrow pits on project plans or in contract specifications for use on a Federal aid project, an archaeological survey will be performed by Department archaeologists prior to award of contract.

This provision also applies to designated disposal sites, staging areas, haul roads, and job site field offices.

August 20, 1975  
Revised April 1, 2004

## **SPECIFIC EQUAL EMPLOYMENT OPPORTUNITY RESPONSIBILITIES** **TRAINING SPECIAL PROVISIONS**

This Training Special Provision supersedes Subparagraph 7b of the Special Provision entitled "Specific Equal Employment Opportunity Responsibilities", (Attachment 1), and is in implementation of 23 U.S.C. 140(a).

As part of the contractor's equal employment opportunity affirmative action program, training shall be provided as follows:

The contractor shall provide on-the-job training aimed at developing full journeymen in the type of trade or job classification involved.

THE NUMBER OF TRAINEES TO BE TRAINED UNDER THE SPECIAL PROVISION WILL BE.  
Bridge – 6 (at 1040 hours each).

In the event that a Contractor subcontracts a portion of the contract work, he shall determine how many, if any, of the trainees are to be trained by the subcontractor, provided however, that the Contractor shall retain the primary responsibility for meeting the training requirements imposed by this Special Provision. The Contractor shall also insure that this training Special Provision is made applicable to such subcontract. Where feasible, 25 percent of apprentices or trainees in each occupation shall be in their first year of apprenticeship or training.

The number of trainees shall be distributed among the work classifications on the basis of the Contractor's needs and the availability of journeymen in the various classifications within a reasonable area of recruitment. Prior to commencing construction, the Contractor shall submit to the State Highway Agency for approval the number of trainees to be trained in each selected classification and training program to be used. Furthermore, the Contractor shall specify the starting time for training in each of the classifications. The Contractor will be credited for each trainee employed by him on the contract work who is currently enrolled or becomes enrolled in an approved program.

Training and upgrading of minorities and women toward journeyman status is a primary objective of this Training Special Provision. Accordingly, the Contractor shall make every effort to enroll minority trainees and women (e.g., by conducting systematic and direct recruitment through public and private sources likely to yield minority and women (trainees)) to the extent that such persons are available within a reasonable area of recruitment. The contractor will be responsible for demonstrating the steps that he has taken in pursuance thereof, prior to a determination as to whether the Contractor is in compliance with this Training Special Provision. This training commitment is not intended, and shall not be used, to discriminate against any applicant for training, whether a member of a minority group or not.

No employee shall be employed as a trainee in any classification in which he has successfully completed a training course leading to journeyman status or in which he has been employed as a journeyman. The Contractor should satisfy this requirement by including appropriate questions in the employee application or by other suitable means. Regardless of the method used the Contractor's records should document the findings in each case.

The minimum length and type of training for each classification will be as established in the training program selected by the Contractor and approved by the State Highway Agency and the Federal Highway Administration. The State Highway Agency and the Federal Highway Administration shall approve a program if it is reasonably calculated to meet the equal employment opportunity obligations of the Contractor and to qualify the average trainee for journeyman status in the classification concerned by the end of the training period. Furthermore, apprenticeship programs registered with the U.S. Department of Labor, Bureau of Apprenticeship and Training, or with a State apprenticeship agency recognized by the Bureau and training programs approved but not necessarily sponsored by the U.S. Department of Labor, Manpower Administration, Bureau of Apprenticeship and Training shall also be considered acceptable provided it is being administered in a manner consistent with the equal employment obligations of Federal Aid highway construction contracts. Approval or acceptance of a training program shall be obtained from the State prior to commencing work on the classification covered by the program. It is the intention of these provisions that training is to be provided in the construction crafts rather than clerk-typists or secretarial-type positions. Training is permissible in lower level management positions such as office engineers, estimators, timekeepers, etc., where the training is oriented toward construction applications. Training in the laborer classification may be permitted provided that significant

and meaningful training is provided and approved by the division office. Some off-site training is permissible as long as the training is an integral part of an approved training program and does not comprise a significant part of the overall training.

Except as otherwise noted below, the cost for the training will be included in the contract price. There will be no reimbursement given by SCDOT for the hours of training that are provided on this project. However, a "Statement of Completed Training" will be required at the end of the project. The fact that the cost of the training must be included in the contract does not prohibit the contractor from receiving training program funds from other sources, if he so desires. Training hours may be counted if training is done off-site where the contractor does one or more of the following and the trainees are concurrently employed on a Federal Aid project: contributes to the cost of the training, provides the instruction to the trainee, or pays the trainee's wages during the off-site training period.

The training requirement will not be considered completed by the Contractor if either the failure to provide the required training, or the failure to hire the trainee as a journeyman, is caused by the Contractor and evidences a lack of good faith on the part of the Contractor in meeting the requirements of this Training Special Provision. It is normally expected that a trainee will begin his training on the project as soon as feasible after start of work the skill involved and remain on the project as long as training opportunities exist in his work classification or until he has completed his training program. It is not required that all trainees be on board for the entire length of the contract. A Contractor will have fulfilled his responsibilities under this Training Special Provision if he has provided acceptable training to the number of trainees specified. The number trained shall be determined on the basis of the total number enrolled on the contract for a significant period.

Trainees will be paid at least 60 percent of the appropriate minimum journeyman's rate specified in the contract for the first half of the training period, 75 percent for the third quarter of the training period, and 90 percent for the last quarter of the training period, unless apprentices or trainees in an approved existing program are enrolled as trainees on this project. In that case, the appropriate rates approved by the Departments of Labor or Transportation in connection with the existing program shall apply to all trainees being trained for the same classification who are covered by this Training Special Provision.

The Contractor shall furnish the trainee a copy of the program he will follow in providing the training. The Contractor shall provide each trainee with a certification showing the type and length of training satisfactorily completed.

The Contractor will provide for the maintenance of records and furnish periodic reports documenting his performance under this Training Special Provision, as required under the SCDOT approved training program.

Meeting the On-the-job Training Requirements or Making Good Faith Efforts to Meet the On-the-job Training Requirements. It is the Contractor's responsibility to meet the On-the-job Training Requirements stated in this section. Failure to meet the requirement or demonstrate good faith efforts, as determined by SCDOT, to meet the requirement may result in any one or more of the following sanctions:

- (1) Withholding monthly progress payments;
- (2) Declaring the Contractor in default pursuant to Section 108.10 of the Standard Specifications and terminating the contract;
- (3) Disqualifying the Contractor from bidding pursuant to Regulation 63-306, Volume 25A, of the S. C. Code of Laws; and/or
- (4) Requiring the Contractor to obtain On-the-job Training participation on future contracts to the extent the Contractor failed to meet or use good faith efforts to meet the On-the-job training contract requirement.



## REQUIRED CONTRACT PROVISIONS FEDERAL-AID CONSTRUCTION CONTRACTS

- I. General
- II. Nondiscrimination
- III. Nonsegregated Facilities
- IV. Davis-Bacon and Related Act Provisions
- V. Contract Work Hours and Safety Standards Act Provisions
- VI. Subletting or Assigning the Contract
- VII. Safety: Accident Prevention
- VIII. False Statements Concerning Highway Projects
- IX. Implementation of Clean Air Act and Federal Water Pollution Control Act
- X. Compliance with Governmentwide Suspension and Debarment Requirements
- XI. Certification Regarding Use of Contract Funds for Lobbying

### ATTACHMENTS

A. Employment and Materials Preference for Appalachian Development Highway System or Appalachian Local Access Road Contracts (included in Appalachian contracts only)

### I. GENERAL

1. Form FHWA-1273 must be physically incorporated in each construction contract funded under Title 23 (excluding emergency contracts solely intended for debris removal). The contractor (or subcontractor) must insert this form in each subcontract and further require its inclusion in all lower tier subcontracts (excluding purchase orders, rental agreements and other agreements for supplies or services).

The applicable requirements of Form FHWA-1273 are incorporated by reference for work done under any purchase order, rental agreement or agreement for other services. The prime contractor shall be responsible for compliance by any subcontractor, lower-tier subcontractor or service provider.

Form FHWA-1273 must be included in all Federal-aid design-build contracts, in all subcontracts and in lower tier subcontracts (excluding subcontracts for design services, purchase orders, rental agreements and other agreements for supplies or services). The design-builder shall be responsible for compliance by any subcontractor, lower-tier subcontractor or service provider.

Contracting agencies may reference Form FHWA-1273 in bid proposal or request for proposal documents, however, the Form FHWA-1273 must be physically incorporated (not referenced) in all contracts, subcontracts and lower-tier subcontracts (excluding purchase orders, rental agreements and other agreements for supplies or services related to a construction contract).

2. Subject to the applicability criteria noted in the following sections, these contract provisions shall apply to all work performed on the contract by the contractor's own organization and with the assistance of workers under the contractor's immediate superintendence and to all work performed on the contract by piecework, station work, or by subcontract.

3. A breach of any of the stipulations contained in these Required Contract Provisions may be sufficient grounds for withholding of progress payments, withholding of final payment, termination of the contract, suspension / debarment or any other action determined to be appropriate by the contracting agency and FHWA.

4. Selection of Labor: During the performance of this contract, the contractor shall not use convict labor for any purpose within the limits of a construction project on a Federal-aid highway unless it is labor performed by convicts who are on parole, supervised release, or probation. The term Federal-aid highway does not include

roadways functionally classified as local roads or rural minor collectors.

### II. NONDISCRIMINATION

The provisions of this section related to 23 CFR Part 230 are applicable to all Federal-aid construction contracts and to all related construction subcontracts of \$10,000 or more. The provisions of 23 CFR Part 230 are not applicable to material supply, engineering, or architectural service contracts.

In addition, the contractor and all subcontractors must comply with the following policies: Executive Order 11246, 41 CFR 60, 29 CFR 1625-1627, Title 23 USC Section 140, the Rehabilitation Act of 1973, as amended (29 USC 794), Title VI of the Civil Rights Act of 1964, as amended, and related regulations including 49 CFR Parts 21, 26 and 27; and 23 CFR Parts 200, 230, and 633.

The contractor and all subcontractors must comply with: the requirements of the Equal Opportunity Clause in 41 CFR 60-1.4(b) and, for all construction contracts exceeding \$10,000, the Standard Federal Equal Employment Opportunity Construction Contract Specifications in 41 CFR 60-4.3.

Note: The U.S. Department of Labor has exclusive authority to determine compliance with Executive Order 11246 and the policies of the Secretary of Labor including 41 CFR 60, and 29 CFR 1625-1627. The contracting agency and the FHWA have the authority and the responsibility to ensure compliance with Title 23 USC Section 140, the Rehabilitation Act of 1973, as amended (29 USC 794), and Title VI of the Civil Rights Act of 1964, as amended, and related regulations including 49 CFR Parts 21, 26 and 27; and 23 CFR Parts 200, 230, and 633.

The following provision is adopted from 23 CFR 230, Appendix A, with appropriate revisions to conform to the U.S. Department of Labor (US DOL) and FHWA requirements.

**1. Equal Employment Opportunity:** Equal employment opportunity (EEO) requirements not to discriminate and to take affirmative action to assure equal opportunity as set forth under laws, executive orders, rules, regulations (28 CFR 35, 29 CFR 1630, 29 CFR 1625-1627, 41 CFR 60 and 49 CFR 27) and orders of the Secretary of Labor as modified by the provisions prescribed herein, and imposed pursuant to 23 U.S.C. 140 shall constitute the EEO and specific affirmative action standards for the contractor's project activities under this contract. The provisions of the Americans with Disabilities Act of 1990 (42 U.S.C. 12101 et seq.) set forth under 28 CFR 35 and 29 CFR 1630 are incorporated by reference in this contract. In the execution of this contract, the contractor agrees to comply with the following minimum specific requirement activities of EEO:

a. The contractor will work with the contracting agency and the Federal Government to ensure that it has made every good faith effort to provide equal opportunity with respect to all of its terms and

conditions of employment and in their review of activities under the contract.

b. The contractor will accept as its operating policy the following statement:

"It is the policy of this Company to assure that applicants are employed, and that employees are treated during employment, without regard to their race, religion, sex, color, national origin, age or disability. Such action shall include: employment, upgrading, demotion, or transfer; recruitment or recruitment advertising; layoff or termination; rates of pay or other forms of compensation; and selection for training, including apprenticeship, pre-apprenticeship, and/or on-the-job training."

**2. EEO Officer:** The contractor will designate and make known to the contracting officers an EEO Officer who will have the responsibility for and must be capable of effectively administering and promoting an active EEO program and who must be assigned adequate authority and responsibility to do so.

**3. Dissemination of Policy:** All members of the contractor's staff who are authorized to hire, supervise, promote, and discharge employees, or who recommend such action, or who are substantially involved in such action, will be made fully cognizant of, and will implement, the contractor's EEO policy and contractual responsibilities to provide EEO in each grade and classification of employment. To ensure that the above agreement will be met, the following actions will be taken as a minimum:

a. Periodic meetings of supervisory and personnel office employees will be conducted before the start of work and then not less often than once every six months, at which time the contractor's EEO policy and its implementation will be reviewed and explained. The meetings will be conducted by the EEO Officer.

b. All new supervisory or personnel office employees will be given a thorough indoctrination by the EEO Officer, covering all major aspects of the contractor's EEO obligations within thirty days following their reporting for duty with the contractor.

c. All personnel who are engaged in direct recruitment for the project will be instructed by the EEO Officer in the contractor's procedures for locating and hiring minorities and women.

d. Notices and posters setting forth the contractor's EEO policy will be placed in areas readily accessible to employees, applicants for employment and potential employees.

e. The contractor's EEO policy and the procedures to implement such policy will be brought to the attention of employees by means of meetings, employee handbooks, or other appropriate means.

**4. Recruitment:** When advertising for employees, the contractor will include in all advertisements for employees the notation: "An Equal Opportunity Employer." All such advertisements will be placed in publications having a large circulation among minorities and women in the area from which the project work force would normally be derived.

a. The contractor will, unless precluded by a valid bargaining agreement, conduct systematic and direct recruitment through public and private employee referral sources likely to yield qualified minorities and women. To meet this requirement, the contractor will identify sources of potential minority group employees, and establish with such identified sources procedures whereby minority and women applicants may be referred to the contractor for employment consideration.

b. In the event the contractor has a valid bargaining agreement providing for exclusive hiring hall referrals, the contractor is expected to observe the provisions of that agreement to the extent that the system meets the contractor's compliance with EEO contract provisions. Where implementation of such an agreement has the effect of discriminating against minorities or women, or

obligates the contractor to do the same, such implementation violates Federal nondiscrimination provisions.

c. The contractor will encourage its present employees to refer minorities and women as applicants for employment. Information and procedures with regard to referring such applicants will be discussed with employees.

**5. Personnel Actions:** Wages, working conditions, and employee benefits shall be established and administered, and personnel actions of every type, including hiring, upgrading, promotion, transfer, demotion, layoff, and termination, shall be taken without regard to race, color, religion, sex, national origin, age or disability. The following procedures shall be followed:

a. The contractor will conduct periodic inspections of project sites to insure that working conditions and employee facilities do not indicate discriminatory treatment of project site personnel.

b. The contractor will periodically evaluate the spread of wages paid within each classification to determine any evidence of discriminatory wage practices.

c. The contractor will periodically review selected personnel actions in depth to determine whether there is evidence of discrimination. Where evidence is found, the contractor will promptly take corrective action. If the review indicates that the discrimination may extend beyond the actions reviewed, such corrective action shall include all affected persons.

d. The contractor will promptly investigate all complaints of alleged discrimination made to the contractor in connection with its obligations under this contract, will attempt to resolve such complaints, and will take appropriate corrective action within a reasonable time. If the investigation indicates that the discrimination may affect persons other than the complainant, such corrective action shall include such other persons. Upon completion of each investigation, the contractor will inform every complainant of all of their avenues of appeal.

**6. Training and Promotion:**

a. The contractor will assist in locating, qualifying, and increasing the skills of minorities and women who are applicants for employment or current employees. Such efforts should be aimed at developing full journey level status employees in the type of trade or job classification involved.

b. Consistent with the contractor's work force requirements and as permissible under Federal and State regulations, the contractor shall make full use of training programs, i.e., apprenticeship, and on-the-job training programs for the geographical area of contract performance. In the event a special provision for training is provided under this contract, this subparagraph will be superseded as indicated in the special provision. The contracting agency may reserve training positions for persons who receive welfare assistance in accordance with 23 U.S.C. 140(a).

c. The contractor will advise employees and applicants for employment of available training programs and entrance requirements for each.

d. The contractor will periodically review the training and promotion potential of employees who

are minorities and women and will encourage eligible employees to apply for such training and promotion.

**7. Unions:** If the contractor relies in whole or in part upon unions as a source of employees, the contractor will use good faith efforts to obtain the cooperation of such unions to increase opportunities for minorities and women. Actions by the contractor, either directly or through a contractor's association acting as agent, will include the procedures set forth below:

a. The contractor will use good faith efforts to develop, in cooperation with the unions, joint training programs aimed toward qualifying more minorities and women for membership in the unions and increasing the skills of minorities and women so that they may qualify for higher paying employment.

b. The contractor will use good faith efforts to incorporate an EEO clause into each union agreement to the end that such union will be contractually bound to refer applicants without regard to their race, color, religion, sex, national origin, age or disability.

c. The contractor is to obtain information as to the referral practices and policies of the labor union except that to the extent such information is within the exclusive possession of the labor union and such labor union refuses to furnish such information to the contractor, the contractor shall so certify to the contracting agency and shall set forth what efforts have been made to obtain such information.

d. In the event the union is unable to provide the contractor with a reasonable flow of referrals within the time limit set forth in the collective bargaining agreement, the contractor will, through independent recruitment efforts, fill the employment vacancies without regard to race, color, religion, sex, national origin, age or disability; making full efforts to obtain qualified and/or qualifiable minorities and women. The failure of a union to provide sufficient referrals (even though it is obligated to provide exclusive referrals under the terms of a collective bargaining agreement) does not relieve the contractor from the requirements of this paragraph. In the event the union referral practice prevents the contractor from meeting the obligations pursuant to Executive Order 11246, as amended, and these special provisions, such contractor shall immediately notify the contracting agency.

**8. Reasonable Accommodation for Applicants / Employees with Disabilities:** The contractor must be familiar with the requirements for and comply with the Americans with Disabilities Act and all rules and regulations established there under. Employers must provide reasonable accommodation in all employment activities unless to do so would cause an undue hardship.

**9. Selection of Subcontractors, Procurement of Materials and Leasing of Equipment:** The contractor shall not discriminate on the grounds of race, color, religion, sex, national origin, age or disability in the selection and retention of subcontractors, including procurement of materials and leases of equipment. The contractor shall take all necessary and reasonable steps to ensure nondiscrimination in the administration of this contract.

a. The contractor shall notify all potential subcontractors and suppliers and lessors of their EEO obligations under this contract.

b. The contractor will use good faith efforts to ensure subcontractor compliance with their EEO obligations.

**10. Assurance Required by 49 CFR 26.13(b):**

a. The requirements of 49 CFR Part 26 and the State DOT's U.S. DOT-approved DBE program are incorporated by reference.

b. The contractor or subcontractor shall not discriminate on the basis of race, color, national origin, or sex in the performance of this contract. The contractor shall carry out applicable requirements of 49 CFR Part 26 in the award and administration of DOT-assisted contracts. Failure by the contractor to carry out these requirements is a material breach of this contract,

which may result in the termination of this contract or such other remedy as the contracting agency deems appropriate.

**11. Records and Reports:** The contractor shall keep such records as necessary to document compliance with the EEO requirements. Such records shall be retained for a period of three years following the date of the final payment to the contractor for all contract work and shall be available at reasonable times and places for inspection by authorized representatives of the contracting agency and the FHWA.

a. The records kept by the contractor shall document the following:

(1) The number and work hours of minority and non-minority group members and women employed in each work classification on the project;

(2) The progress and efforts being made in cooperation with unions, when applicable, to increase employment opportunities for minorities and women; and

(3) The progress and efforts being made in locating, hiring, training, qualifying, and upgrading minorities and women;

b. The contractors and subcontractors will submit an annual report to the contracting agency each July for the duration of the project, indicating the number of minority, women, and non-minority group employees currently engaged in each work classification required by the contract work. This information is to be reported on [Form FHWA-1391](#). The staffing data should represent the project work force on board in all or any part of the last payroll period preceding the end of July. If on-the-job training is being required by special provision, the contractor will be required to collect and report training data. The employment data should reflect the work force on board during all or any part of the last payroll period preceding the end of July.

### III. NONSEGREGATED FACILITIES

This provision is applicable to all Federal-aid construction contracts and to all related construction subcontracts of \$10,000 or more.

The contractor must ensure that facilities provided for employees are provided in such a manner that segregation on the basis of race, color, religion, sex, or national origin cannot result. The contractor may neither require such segregated use by written or oral policies nor tolerate such use by employee custom. The contractor's obligation extends further to ensure that its employees are not assigned to perform their services at any location, under the contractor's control, where the facilities are segregated. The term "facilities" includes waiting rooms, work areas, restaurants and other eating areas, time clocks, restrooms, washrooms, locker rooms, and other storage or dressing areas, parking lots, drinking fountains, recreation or entertainment areas, transportation, and housing provided for employees. The contractor shall provide separate or single-user restrooms and necessary dressing or sleeping areas to assure privacy between sexes.

### IV. Davis-Bacon and Related Act Provisions

This section is applicable to all Federal-aid construction projects exceeding \$2,000 and to all related subcontracts and lower-tier subcontracts (regardless of subcontract size). The requirements apply to all projects located within the right-of-way of a roadway that is functionally classified as Federal-aid highway. This excludes roadways functionally classified as local roads or rural minor collectors, which are exempt. Contracting agencies may elect to apply these requirements to other projects.

The following provisions are from the U.S. Department of Labor regulations in 29 CFR 5.5 "Contract provisions and related matters" with minor revisions to conform to the FHWA-1273 format and FHWA program requirements.

## 1. Minimum wages

a. All laborers and mechanics employed or working upon the site of the work, will be paid unconditionally and not less often than once a week, and without subsequent deduction or rebate on any account (except such payroll deductions as are permitted by regulations issued by the Secretary of Labor under the Copeland Act (29 CFR part 3)), the full amount of wages and bona fide fringe benefits (or cash equivalents thereof) due at time of payment computed at rates not less than those contained in the wage determination of the Secretary of Labor which is attached hereto and made a part hereof, regardless of any contractual relationship which may be alleged to exist between the contractor and such laborers and mechanics.

Contributions made or costs reasonably anticipated for bona fide fringe benefits under section 1(b)(2) of the Davis-Bacon Act on behalf of laborers or mechanics are considered wages paid to such laborers or mechanics, subject to the provisions of paragraph 1.d. of this section; also, regular contributions made or costs incurred for more than a weekly period (but not less often than quarterly) under plans, funds, or programs which cover the particular weekly period, are deemed to be constructively made or incurred during such weekly period. Such laborers and mechanics shall be paid the appropriate wage rate and fringe benefits on the wage determination for the classification of work actually performed, without regard to skill, except as provided in 29 CFR 5.5(a)(4). Laborers or mechanics performing work in more than one classification may be compensated at the rate specified for each classification for the time actually worked therein: Provided, That the employer's payroll records accurately set forth the time spent in each classification in which work is performed. The wage determination (including any additional classification and wage rates conformed under paragraph 1.b. of this section) and the Davis-Bacon poster (WH-1321) shall be posted at all times by the contractor and its subcontractors at the site of the work in a prominent and accessible place where it can be easily seen by the workers.

b. (1) The contracting officer shall require that any class of laborers or mechanics, including helpers, which is not listed in the wage determination and which is to be employed under the contract shall be classified in conformance with the wage determination. The contracting officer shall approve an additional classification and wage rate and fringe benefits therefore only when the following criteria have been met:

- (i) The work to be performed by the classification requested is not performed by a classification in the wage determination; and
- (ii) The classification is utilized in the area by the construction industry; and
- (iii) The proposed wage rate, including any bona fide fringe benefits, bears a reasonable relationship to the wage rates contained in the wage determination.

(2) If the contractor and the laborers and mechanics to be employed in the classification (if known), or their representatives, and the contracting officer agree on the classification and wage rate (including the amount designated for fringe benefits where appropriate), a report of the action taken shall be sent by the contracting officer to the Administrator of the Wage and Hour

Division, Employment Standards Administration, U.S. Department of Labor, Washington, DC 20210. The Administrator, or an authorized representative, will approve, modify, or disapprove every additional classification action within 30 days of receipt and so advise the contracting officer or will notify the contracting officer within the 30-day period that additional time is necessary.

(3) In the event the contractor, the laborers or mechanics to be employed in the classification or their representatives, and the contracting officer do not agree on the proposed classification and wage rate (including the amount designated for fringe benefits, where appropriate), the contracting officer shall refer the questions, including the views of all interested parties and the recommendation of the contracting officer, to the Wage and Hour Administrator for determination. The Wage and Hour Administrator, or an authorized representative, will issue a determination within 30 days of receipt and so advise the contracting officer or will notify the contracting officer within the 30-day period that additional time is necessary.

(4) The wage rate (including fringe benefits where appropriate) determined pursuant to paragraphs 1.b.(2) or 1.b.(3) of this section, shall be paid to all workers performing work in the classification under this contract from the first day on which work is performed in the classification.

c. Whenever the minimum wage rate prescribed in the contract for a class of laborers or mechanics includes a fringe benefit which is not expressed as an hourly rate, the contractor shall either pay the benefit as stated in the wage determination or shall pay another bona fide fringe benefit or an hourly cash equivalent thereof.

d. If the contractor does not make payments to a trustee or other third person, the contractor may consider as part of the wages of any laborer or mechanic the amount of any costs reasonably anticipated in providing bona fide fringe benefits under a plan or program. Provided, That the Secretary of Labor has found, upon the written request of the contractor, that the applicable standards of the Davis-Bacon Act have been met. The Secretary of Labor may require the contractor to set aside in a separate account assets for the meeting of obligations under the plan or program.

## 2. Withholding

The contracting agency shall upon its own action or upon written request of an authorized representative of the Department of Labor, withhold or cause to be withheld from the contractor under this contract, or any other Federal contract with the same prime contractor, or any other federally-assisted contract subject to Davis-Bacon prevailing wage requirements, which is held by the same prime contractor, so much of the accrued payments or advances as may be considered necessary to pay laborers and mechanics, including apprentices, trainees, and helpers, employed by the contractor or any subcontractor the full amount of wages required by the contract. In the event of failure to pay any laborer or mechanic, including any apprentice, trainee, or helper, employed or working on the site of the work, all or part of the wages required by the contract, the contracting agency may, after written notice to the contractor, take such action as may be necessary to cause the suspension of any further

payment, advance, or guarantee of funds until such violations have ceased.

### 3. Payrolls and basic records

a. Payrolls and basic records relating thereto shall be maintained by the contractor during the course of the work and preserved for a period of three years thereafter for all laborers and mechanics working at the site of the work. Such records shall contain the name, address, and social security number of each such worker, his or her correct classification, hourly rates of wages paid (including rates of contributions or costs anticipated for bona fide fringe benefits or cash equivalents thereof of the types described in section 1(b)(2)(B) of the Davis-Bacon Act), daily and weekly number of hours worked, deductions made and actual wages paid. Whenever the Secretary of Labor has found under 29 CFR 5.5(a)(1)(iv) that the wages of any laborer or mechanic include the amount of any costs reasonably anticipated in providing benefits under a plan or program described in section 1(b)(2)(B) of the Davis-Bacon Act, the contractor shall maintain records which show that the commitment to provide such benefits is enforceable, that the plan or program is financially responsible, and that the plan or program has been communicated in writing to the laborers or mechanics affected, and records which show the costs anticipated or the actual cost incurred in providing such benefits. Contractors employing apprentices or trainees under approved programs shall maintain written evidence of the registration of apprenticeship programs and certification of trainee programs, the registration of the apprentices and trainees, and the ratios and wage rates prescribed in the applicable programs.

b. (1) The contractor shall submit weekly for each week in which any contract work is performed a copy of all payrolls to the contracting agency. The payrolls submitted shall set out accurately and completely all of the information required to be maintained under 29 CFR 5.5(a)(3)(i), except that full social security numbers and home addresses shall not be included on weekly transmittals. Instead the payrolls shall only need to include an individually identifying number for each employee ( e.g. , the last four digits of the employee's social security number). The required weekly payroll information may be submitted in any form desired. Optional Form WH-347 is available for this purpose from the Wage and Hour Division Web site at <http://www.dol.gov/esa/whd/forms/wh347instr.htm> or its successor site. The prime contractor is responsible for the submission of copies of payrolls by all subcontractors. Contractors and subcontractors shall maintain the full social security number and current address of each covered worker, and shall provide them upon request to the contracting agency for transmission to the State DOT, the FHWA or the Wage and Hour Division of the Department of Labor for purposes of an investigation or audit of compliance with prevailing wage requirements. It is not a violation of this section for a prime contractor to require a subcontractor to provide addresses and social security numbers to the prime contractor for its own records, without weekly submission to the contracting agency..

(2) Each payroll submitted shall be accompanied by a "Statement of Compliance," signed by the contractor or subcontractor or his or her agent who pays or supervises the payment of the persons employed under the contract and shall certify the following:

(i) That the payroll for the payroll period contains the information required to be provided under §5.5 (a)(3)(ii) of Regulations, 29 CFR part 5, the appropriate information is being maintained under §5.5 (a)(3)(i) of Regulations, 29 CFR part 5, and that such information is correct and complete;

(ii) That each laborer or mechanic (including each helper, apprentice, and trainee) employed on the contract during the payroll period has been paid the full weekly wages earned, without rebate, either directly or indirectly, and that no deductions have been made either directly or indirectly from the full wages earned, other than permissible deductions as set forth in Regulations, 29 CFR part 3;

(iii) That each laborer or mechanic has been paid not less than the applicable wage rates and fringe benefits or cash equivalents for the classification of work performed, as specified in the applicable wage determination incorporated into the contract.

(3) The weekly submission of a properly executed certification set forth on the reverse side of Optional Form WH-347 shall satisfy the requirement for submission of the "Statement of Compliance" required by paragraph 3.b.(2) of this section.

(4) The falsification of any of the above certifications may subject the contractor or subcontractor to civil or criminal prosecution under section 1001 of title 18 and section 231 of title 31 of the United States Code.

c. The contractor or subcontractor shall make the records required under paragraph 3.a. of this section available for inspection, copying, or transcription by authorized representatives of the contracting agency, the State DOT, the FHWA, or the Department of Labor, and shall permit such representatives to interview employees during working hours on the job. If the contractor or subcontractor fails to submit the required records or to make them available, the FHWA may, after written notice to the contractor, the contracting agency or the State DOT, take such action as may be necessary to cause the suspension of any further payment, advance, or guarantee of funds. Furthermore, failure to submit the required records upon request or to make such records available may be grounds for debarment action pursuant to 29 CFR 5.12.

### 4. Apprentices and trainees

a. Apprentices (programs of the USDOL).

Apprentices will be permitted to work at less than the predetermined rate for the work they performed when they are employed pursuant to and individually registered in a bona fide apprenticeship program registered with the U.S. Department of Labor, Employment and Training Administration, Office of Apprenticeship Training, Employer and Labor Services, or with a State Apprenticeship Agency recognized by the Office, or if a person is employed in his or her first 90 days of probationary employment as an apprentice in such an apprenticeship program, who is not individually registered in the program, but who has been certified by the Office of Apprenticeship Training, Employer and Labor Services or a State Apprenticeship Agency (where appropriate) to be eligible for probationary employment as an apprentice.

The allowable ratio of apprentices to journeymen on the job site in any craft classification shall not be greater than the ratio permitted to the contractor as to the entire work force under the registered program. Any worker listed on a payroll at an apprentice wage rate, who is not registered or otherwise employed as stated above, shall be paid not less than the applicable wage rate on the wage determination for the classification of work actually performed. In addition, any apprentice performing work on the job site in excess of the ratio permitted under the registered program shall be paid not less than the applicable wage rate on the wage determination for the work actually performed. Where a contractor is performing construction on a project in

a locality other than that in which its program is registered, the ratios and wage rates (expressed in percentages of the journeyman's hourly rate) specified in the contractor's or subcontractor's registered program shall be observed.

Every apprentice must be paid at not less than the rate specified in the registered program for the apprentice's level of progress, expressed as a percentage of the journeymen hourly rate specified in the applicable wage determination. Apprentices shall be paid fringe benefits in accordance with the provisions of the apprenticeship program. If the apprenticeship program does not specify fringe benefits, apprentices must be paid the full amount of fringe benefits listed on the wage determination for the applicable classification. If the Administrator determines that a different practice prevails for the applicable apprentice classification, fringes shall be paid in accordance with that determination.

In the event the Office of Apprenticeship Training, Employer and Labor Services, or a State Apprenticeship Agency recognized by the Office, withdraws approval of an apprenticeship program, the contractor will no longer be permitted to utilize apprentices at less than the applicable predetermined rate for the work performed until an acceptable program is approved.

b. Trainees (programs of the USDOL).

Except as provided in 29 CFR 5.16, trainees will not be permitted to work at less than the predetermined rate for the work performed unless they are employed pursuant to and individually registered in a program which has received prior approval, evidenced by formal certification by the U.S. Department of Labor, Employment and Training Administration.

The ratio of trainees to journeymen on the job site shall not be greater than permitted under the plan approved by the Employment and Training Administration.

Every trainee must be paid at not less than the rate specified in the approved program for the trainee's level of progress, expressed as a percentage of the journeyman hourly rate specified in the applicable wage determination. Trainees shall be paid fringe benefits in accordance with the provisions of the trainee program. If the trainee program does not mention fringe benefits, trainees shall be paid the full amount of fringe benefits listed on the wage determination unless the Administrator of the Wage and Hour Division determines that there is an apprenticeship program associated with the corresponding journeyman wage rate on the wage determination which provides for less than full fringe benefits for apprentices. Any employee listed on the payroll at a trainee rate who is not registered and participating in a training plan approved by the Employment and Training Administration shall be paid not less than the applicable wage rate on the wage determination for the classification of work actually performed. In addition, any trainee performing work on the job site in excess of the ratio permitted under the registered program shall be paid not less than the applicable wage rate on the wage determination for the work actually performed.

In the event the Employment and Training Administration withdraws approval of a training program, the contractor will no longer be permitted to utilize trainees at less than the applicable predetermined rate for the work performed until an acceptable program is approved.

c. Equal employment opportunity. The utilization of apprentices, trainees and journeymen under this part shall be in conformity with the equal employment opportunity requirements of Executive Order 11246, as amended, and 29 CFR part 30.

d. Apprentices and Trainees (programs of the U.S. DOT).

Apprentices and trainees working under apprenticeship and skill training programs which have been certified by the Secretary of Transportation as promoting EEO in connection with Federal-aid highway construction programs are not subject to the requirements of paragraph 4 of this Section IV. The straight time hourly wage

rates for apprentices and trainees under such programs will be established by the particular programs. The ratio of apprentices and trainees to journeymen shall not be greater than permitted by the terms of the particular program.

**5. Compliance with Copeland Act requirements.**

The contractor shall comply with the requirements of 29 CFR part 3, which are incorporated by reference in this contract.

**6. Subcontracts.** The contractor or subcontractor shall insert Form FHWA-1273 in any subcontracts and also require the subcontractors to include Form FHWA-1273 in any lower tier subcontracts. The prime contractor shall be responsible for the compliance by any subcontractor or lower tier subcontractor with all the contract clauses in 29 CFR 5.5.

**7. Contract termination: debarment.** A breach of the contract clauses in 29 CFR 5.5 may be grounds for termination of the contract, and for debarment as a contractor and a subcontractor as provided in 29 CFR 5.12.

**8. Compliance with Davis-Bacon and Related Act requirements.** All rulings and interpretations of the Davis-Bacon and Related Acts contained in 29 CFR parts 1, 3, and 5 are herein incorporated by reference in this contract.

**9. Disputes concerning labor standards.** Disputes arising out of the labor standards provisions of this contract shall not be subject to the general disputes clause of this contract. Such disputes shall be resolved in accordance with the procedures of the Department of Labor set forth in 29 CFR parts 5, 6, and 7. Disputes within the meaning of this clause include disputes between the contractor (or any of its subcontractors) and the contracting agency, the U.S. Department of Labor, or the employees or their representatives.

**10. Certification of eligibility.**

a. By entering into this contract, the contractor certifies that neither it (nor he or she) nor any person or firm who has an interest in the contractor's firm is a person or firm ineligible to be awarded Government contracts by virtue of section 3(a) of the Davis-Bacon Act or 29 CFR 5.12(a)(1).

b. No part of this contract shall be subcontracted to any person or firm ineligible for award of a Government contract by virtue of section 3(a) of the Davis-Bacon Act or 29 CFR 5.12(a)(1).

c. The penalty for making false statements is prescribed in the U.S. Criminal Code, 18 U.S.C. 1001.

**V. CONTRACT WORK HOURS AND SAFETY STANDARDS ACT**

The following clauses apply to any Federal-aid construction contract in an amount in excess of \$100,000 and subject to the overtime provisions of the Contract Work Hours and Safety Standards Act. These clauses shall be inserted in addition to the clauses required by 29 CFR 5.5(a) or 29 CFR 4.6. As used in this paragraph, the terms laborers and mechanics include watchmen and guards.

**1. Overtime requirements.** No contractor or subcontractor contracting for any part of the contract work which may require or involve the employment of laborers or mechanics shall require or permit any such laborer or mechanic in any workweek in which he or she is employed on such work to work in excess of forty hours in such workweek unless such laborer or mechanic receives compensation at a rate not less than one and one-half times the basic rate of pay for all hours worked in excess of forty hours in such workweek.

**2. Violation; liability for unpaid wages; liquidated damages.** In the event of any violation of the clause set forth in paragraph (1.) of this section, the contractor and any subcontractor responsible therefor shall be liable for the unpaid wages. In addition, such contractor and subcontractor shall be liable to the United States (in the case of work done under contract for the District of Columbia or a territory, to such District or to such territory), for liquidated damages. Such liquidated damages shall be computed with respect to each individual laborer or mechanic, including watchmen and guards, employed in violation of the clause set forth in paragraph (1.) of this section, in the sum of \$10 for each calendar day on which such individual was required or permitted to work in excess of the standard workweek of forty hours without payment of the overtime wages required by the clause set forth in paragraph (1.) of this section.

**3. Withholding for unpaid wages and liquidated damages.** The FHWA or the contracting agency shall upon its own action or upon written request of an authorized representative of the Department of Labor withhold or cause to be withheld, from any moneys payable on account of work performed by the contractor or subcontractor under any such contract or any other Federal contract with the same prime contractor, or any other federally-assisted contract subject to the Contract Work Hours and Safety Standards Act, which is held by the same prime contractor, such sums as may be determined to be necessary to satisfy any liabilities of such contractor or subcontractor for unpaid wages and liquidated damages as provided in the clause set forth in paragraph (2.) of this section.

**4. Subcontracts.** The contractor or subcontractor shall insert in any subcontracts the clauses set forth in paragraph (1.) through (4.) of this section and also a clause requiring the subcontractors to include these clauses in any lower tier subcontracts. The prime contractor shall be responsible for compliance by any subcontractor or lower tier subcontractor with the clauses set forth in paragraphs (1.) through (4.) of this section.

## VI. SUBLETTING OR ASSIGNING THE CONTRACT

This provision is applicable to all Federal-aid construction contracts on the National Highway System.

1. The contractor shall perform with its own organization contract work amounting to not less than 30 percent (or a greater percentage if specified elsewhere in the contract) of the total original contract price, excluding any specialty items designated by the contracting agency. Specialty items may be performed by subcontract and the amount of any such specialty items performed may be deducted from the total original contract price before computing the amount of work required to be performed by the contractor's own organization (23 CFR 635.116).

a. The term "perform work with its own organization" refers to workers employed or leased by the prime contractor, and equipment owned or rented by the prime contractor, with or without operators. Such term does not include employees or equipment of a subcontractor or lower tier subcontractor, agents of the prime contractor, or any other assignees. The term may include payments for the costs of hiring leased employees from an employee leasing firm meeting all relevant Federal and State regulatory requirements. Leased employees may only be included in this term if the prime contractor meets all of the following conditions:

(1) the prime contractor maintains control over the supervision of the day-to-day activities of the leased employees;

(2) the prime contractor remains responsible for the quality of the work of the leased employees;

(3) the prime contractor retains all power to accept or exclude individual employees from work on the project; and

(4) the prime contractor remains ultimately responsible for the payment of predetermined minimum wages, the submission of payrolls, statements of compliance and all other Federal regulatory requirements.

b. "Specialty Items" shall be construed to be limited to work that requires highly specialized knowledge, abilities, or equipment not ordinarily available in the type of contracting organizations qualified and expected to bid or propose on the contract as a whole and in general are to be limited to minor components of the overall contract.

2. The contract amount upon which the requirements set forth in paragraph (1) of Section VI is computed includes the cost of material and manufactured products which are to be purchased or produced by the contractor under the contract provisions.

3. The contractor shall furnish (a) a competent superintendent or supervisor who is employed by the firm, has full authority to direct performance of the work in accordance with the contract requirements, and is in charge of all construction operations (regardless of who performs the work) and (b) such other of its own organizational resources (supervision, management, and engineering services) as the contracting officer determines is necessary to assure the performance of the contract.

4. No portion of the contract shall be sublet, assigned or otherwise disposed of except with the written consent of the contracting officer, or authorized representative, and such consent when given shall not be construed to relieve the contractor of any responsibility for the fulfillment of the contract. Written consent will be given only after the contracting agency has assured that each subcontract is evidenced in writing and that it contains all pertinent provisions and requirements of the prime contract.

5. The 30% self-performance requirement of paragraph (1) is not applicable to design-build contracts; however, contracting agencies may establish their own self-performance requirements.

## VII. SAFETY: ACCIDENT PREVENTION

This provision is applicable to all Federal-aid construction contracts and to all related subcontracts.

1. In the performance of this contract the contractor shall comply with all applicable Federal, State, and local laws governing safety, health, and sanitation (23 CFR 635). The contractor shall provide all safeguards, safety devices and protective equipment and take any other needed actions as it determines, or as the contracting officer may determine, to be reasonably necessary to protect the life and health of employees on the job and the safety of the public and to protect property in connection with the performance of the work covered by the contract.

2. It is a condition of this contract, and shall be made a condition of each subcontract, which the contractor enters into pursuant to this contract, that the contractor and any subcontractor shall not permit any

employee, in performance of the contract, to work in surroundings or under conditions which are unsanitary, hazardous or dangerous to his/her health or safety, as determined under construction safety and health standards (29 CFR 1926) promulgated by the Secretary of Labor, in accordance with Section 107 of the Contract Work Hours and Safety Standards Act (40 U.S.C. 3704).

3. Pursuant to 29 CFR 1926.3, it is a condition of this contract that the Secretary of Labor or authorized representative thereof, shall have right of entry to any site of contract performance to inspect or investigate the matter of compliance with the construction safety and health standards and to carry out the duties of the Secretary under Section 107 of the Contract Work Hours and Safety Standards Act (40 U.S.C.3704).

### **VIII. FALSE STATEMENTS CONCERNING HIGHWAY PROJECTS**

This provision is applicable to all Federal-aid construction contracts and to all related subcontracts.

In order to assure high quality and durable construction in conformity with approved plans and specifications and a high degree of reliability on statements and representations made by engineers, contractors, suppliers, and workers on Federal-aid highway projects, it is essential that all persons concerned with the project perform their functions as carefully, thoroughly, and honestly as possible. Willful falsification, distortion, or misrepresentation with respect to any facts related to the project is a violation of Federal law. To prevent any misunderstanding regarding the seriousness of these and similar acts, Form FHWA-1022 shall be posted on each Federal-aid highway project (23 CFR 635) in one or more places where it is readily available to all persons concerned with the project:

18 U.S.C. 1020 reads as follows:

"Whoever, being an officer, agent, or employee of the United States, or of any State or Territory, or whoever, whether a person, association, firm, or corporation, knowingly makes any false statement, false representation, or false report as to the character, quality, quantity, or cost of the material used or to be used, or the quantity or quality of the work performed or to be performed, or the cost thereof in connection with the submission of plans, maps, specifications, contracts, or costs of construction on any highway or related project submitted for approval to the Secretary of Transportation; or

Whoever knowingly makes any false statement, false representation, false report or false claim with respect to the character, quality, quantity, or cost of any work performed or to be performed, or materials furnished or to be furnished, in connection with the construction of any highway or related project approved by the Secretary of Transportation; or

Whoever knowingly makes any false statement or false representation as to material fact in any statement, certificate, or report submitted pursuant to provisions of the Federal-aid Roads Act approved July 1, 1916, (39 Stat. 355), as amended and supplemented;

Shall be fined under this title or imprisoned not more than 5 years or both."

### **IX. IMPLEMENTATION OF CLEAN AIR ACT AND FEDERAL WATER POLLUTION CONTROL ACT**

This provision is applicable to all Federal-aid construction contracts and to all related subcontracts.

By submission of this bid/proposal or the execution of this contract, or subcontract, as appropriate, the bidder, proposer, Federal-aid construction contractor, or subcontractor, as appropriate, will be deemed to have stipulated as follows:

1. That any person who is or will be utilized in the performance of this contract is not prohibited from receiving an award due to a violation of Section 508 of the Clean Water Act or Section 306 of the Clean Air Act.

2. That the contractor agrees to include or cause to be included the requirements of paragraph (1) of this Section X in every subcontract, and further agrees to take such action as the contracting agency may direct as a means of enforcing such requirements.

### **X. CERTIFICATION REGARDING DEBARMENT, SUSPENSION, INELIGIBILITY AND VOLUNTARY EXCLUSION**

This provision is applicable to all Federal-aid construction contracts, design-build contracts, subcontracts, lower-tier subcontracts, purchase orders, lease agreements, consultant contracts or any other covered transaction requiring FHWA approval or that is estimated to cost \$25,000 or more – as defined in 2 CFR Parts 180 and 1200.

#### **1. Instructions for Certification – First Tier Participants:**

a. By signing and submitting this proposal, the prospective first tier participant is providing the certification set out below.

b. The inability of a person to provide the certification set out below will not necessarily result in denial of participation in this covered transaction. The prospective first tier participant shall submit an explanation of why it cannot provide the certification set out below. The certification or explanation will be considered in connection with the department or agency's determination whether to enter into this transaction. However, failure of the prospective first tier participant to furnish a certification or an explanation shall disqualify such a person from participation in this transaction.

c. The certification in this clause is a material representation of fact upon which reliance was placed when the contracting agency determined to enter into this transaction. If it is later determined that the prospective participant knowingly rendered an erroneous certification, in addition to other remedies available to the Federal Government, the contracting agency may terminate this transaction for cause of default.

d. The prospective first tier participant shall provide immediate written notice to the contracting agency to whom this proposal is submitted if any time the prospective first tier participant learns that its certification was erroneous when submitted or has become erroneous by reason of changed circumstances.

e. The terms "covered transaction," "debarred," "suspended," "ineligible," "participant," "person," "principal," and "voluntarily excluded," as used in this clause, are defined in 2 CFR Parts 180 and 1200. "First Tier Covered Transactions" refers to any covered transaction between a grantee or subgrantee of Federal funds and a participant (such as the prime or general contract). "Lower Tier Covered Transactions" refers to any covered transaction under a First Tier Covered Transaction (such as subcontracts). "First Tier Participant" refers to the participant who has entered into a covered transaction with a grantee or subgrantee of Federal



funds (such as the prime or general contractor). "Lower Tier Participant" refers any participant who has entered into a covered transaction with a First Tier Participant or other Lower Tier Participants (such as subcontractors and suppliers).

f. The prospective first tier participant agrees by submitting this proposal that, should the proposed covered transaction be entered into, it shall not knowingly enter into any lower tier covered transaction with a person who is debarred, suspended, declared ineligible, or voluntarily excluded from participation in this covered transaction, unless authorized by the department or agency entering into this transaction.

g. The prospective first tier participant further agrees by submitting this proposal that it will include the clause titled "Certification Regarding Debarment, Suspension, Ineligibility and Voluntary Exclusion-Lower Tier Covered Transactions," provided by the department or contracting agency, entering into this covered transaction, without modification, in all lower tier covered transactions and in all solicitations for lower tier covered transactions exceeding the \$25,000 threshold.

h. A participant in a covered transaction may rely upon a certification of a prospective participant in a lower tier covered transaction that is not debarred, suspended, ineligible, or voluntarily excluded from the covered transaction, unless it knows that the certification is erroneous. A participant is responsible for ensuring that its principals are not suspended, debarred, or otherwise ineligible to participate in covered transactions. To verify the eligibility of its principals, as well as the eligibility of any lower tier prospective participants, each participant may, but is not required to, check the Excluded Parties List System website (<https://www.epls.gov/>), which is compiled by the General Services Administration.

i. Nothing contained in the foregoing shall be construed to require the establishment of a system of records in order to render in good faith the certification required by this clause. The knowledge and information of the prospective participant is not required to exceed that which is normally possessed by a prudent person in the ordinary course of business dealings.

j. Except for transactions authorized under paragraph (f) of these instructions, if a participant in a covered transaction knowingly enters into a lower tier covered transaction with a person who is suspended, debarred, ineligible, or voluntarily excluded from participation in this transaction, in addition to other remedies available to the Federal Government, the department or agency may terminate this transaction for cause or default.

\*\*\*\*\*

## **2. Certification Regarding Debarment, Suspension, Ineligibility and Voluntary Exclusion – First Tier Participants:**

a. The prospective first tier participant certifies to the best of its knowledge and belief, that it and its principals:

(1) Are not presently debarred, suspended, proposed for debarment, declared ineligible, or voluntarily excluded from participating in covered transactions by any Federal department or agency;

(2) Have not within a three-year period preceding this proposal been convicted of or had a civil judgment rendered against them for commission of fraud or a criminal offense in connection with obtaining, attempting to obtain, or performing a public (Federal, State or local) transaction or contract under a public transaction; violation of Federal or State antitrust statutes or commission of embezzlement, theft, forgery, bribery, falsification or destruction of records, making false statements, or receiving stolen property;

(3) Are not presently indicted for or otherwise criminally or civilly charged by a governmental entity (Federal, State or local) with commission of any of the offenses enumerated in paragraph (a)(2) of this certification; and

(4) Have not within a three-year period preceding this application/proposal had one or more public transactions (Federal, State or local) terminated for cause or default.

b. Where the prospective participant is unable to certify to any of the statements in this certification, such prospective participant shall attach an explanation to this proposal.

## **2. Instructions for Certification - Lower Tier Participants:**

(Applicable to all subcontracts, purchase orders and other lower tier transactions requiring prior FHWA approval or estimated to cost \$25,000 or more - 2 CFR Parts 180 and 1200)

a. By signing and submitting this proposal, the prospective lower tier is providing the certification set out below.

b. The certification in this clause is a material representation of fact upon which reliance was placed when this transaction was entered into. If it is later determined that the prospective lower tier participant knowingly rendered an erroneous certification, in addition to other remedies available to the Federal Government, the department, or agency with which this transaction originated may pursue available remedies, including suspension and/or debarment.

c. The prospective lower tier participant shall provide immediate written notice to the person to which this proposal is submitted if at any time the prospective lower tier participant learns that its certification was erroneous by reason of changed circumstances.

d. The terms "covered transaction," "debarred," "suspended," "ineligible," "participant," "person," "principal," and "voluntarily excluded," as used in this clause, are defined in 2 CFR Parts 180 and 1200. You may contact the person to which this proposal is submitted for assistance in obtaining a copy of those regulations. "First Tier Covered Transactions" refers to any covered transaction between a grantee or subgrantee of Federal funds and a participant (such as the prime or general contract). "Lower Tier Covered Transactions" refers to any covered transaction under a First Tier Covered Transaction (such as subcontracts). "First Tier Participant" refers to the participant who has entered into a covered transaction with a grantee or subgrantee of Federal funds (such as the prime or general contractor). "Lower Tier Participant" refers any participant who has entered into a covered transaction with a First Tier Participant or other Lower Tier Participants (such as subcontractors and suppliers).

e. The prospective lower tier participant agrees by submitting this proposal that, should the proposed covered transaction be entered into, it shall not knowingly enter into any lower tier covered transaction with a person who is debarred, suspended, declared ineligible, or voluntarily excluded from participation in this covered transaction, unless authorized by the department or agency with which this transaction originated.

f. The prospective lower tier participant further agrees by submitting this proposal that it will include this clause titled "Certification Regarding Debarment, Suspension, Ineligibility and Voluntary Exclusion-

Lower Tier Covered Transaction," without modification, in all lower tier covered transactions and in all solicitations for lower tier covered transactions exceeding the \$25,000 threshold.

g. A participant in a covered transaction may rely upon a certification of a prospective participant in a lower tier covered transaction that is not debarred, suspended, ineligible, or voluntarily excluded from the covered transaction, unless it knows that the certification is erroneous. A participant is responsible for ensuring that its principals are not suspended, debarred, or otherwise ineligible to participate in covered transactions. To verify the eligibility of its principals, as well as the eligibility of any lower tier prospective participants, each participant may, but is not required to, check the Excluded Parties List System website (<https://www.epls.gov>), which is compiled by the General Services Administration.

h. Nothing contained in the foregoing shall be construed to require establishment of a system of records in order to render in good faith the certification required by this clause. The knowledge and information of participant is not required to exceed that which is normally possessed by a prudent person in the ordinary course of business dealings.

i. Except for transactions authorized under paragraph e of these instructions, if a participant in a covered transaction knowingly enters into a lower tier covered transaction with a person who is suspended, debarred, ineligible, or voluntarily excluded from participation in this transaction, in addition to other remedies available to the Federal Government, the department or agency with which this transaction originated may pursue available remedies, including suspension and/or debarment.

\* \* \* \* \*

**Certification Regarding Debarment, Suspension, Ineligibility and Voluntary Exclusion--Lower Tier Participants:**

1. The prospective lower tier participant certifies, by submission of this proposal, that neither it nor its principals is presently debarred, suspended, proposed for debarment, declared ineligible, or voluntarily excluded from participating in covered transactions by any Federal department or agency.

2. Where the prospective lower tier participant is unable to certify to any of the statements in this certification, such prospective participant shall attach an explanation to this proposal.

\* \* \* \* \*

**XI. CERTIFICATION REGARDING USE OF CONTRACT FUNDS FOR LOBBYING**

This provision is applicable to all Federal-aid construction contracts and to all related subcontracts which exceed \$100,000 (49 CFR 20).

1. The prospective participant certifies, by signing and submitting this bid or proposal, to the best of his or her knowledge and belief, that:

a. No Federal appropriated funds have been paid or will be paid, by or on behalf of the undersigned, to any person for influencing or attempting to influence an officer or employee of any Federal agency, a Member of Congress, an officer or employee of Congress, or an employee of a Member of Congress in connection with the awarding of any Federal contract, the making of any Federal grant, the making of any Federal loan, the entering into of any cooperative agreement, and the extension, continuation, renewal, amendment, or modification of any Federal contract, grant, loan, or cooperative agreement.

b. If any funds other than Federal appropriated funds have been paid or will be paid to any person for influencing or attempting to influence an officer or employee of any Federal agency, a Member of Congress, an officer or employee of Congress, or an employee of a Member of Congress in connection with this Federal contract,

grant, loan, or cooperative agreement, the undersigned shall complete and submit Standard Form-LLL, "Disclosure Form to Report Lobbying," in accordance with its instructions.

2. This certification is a material representation of fact upon which reliance was placed when this transaction was made or entered into. Submission of this certification is a prerequisite for making or entering into this transaction imposed by 31 U.S.C. 1352. Any person who fails to file the required certification shall be subject to a civil penalty of not less than \$10,000 and not more than \$100,000 for each such failure.

3. The prospective participant also agrees by submitting its bid or proposal that the participant shall require that the language of this certification be included in all lower tier subcontracts, which exceed \$100,000 and that all such recipients shall certify and disclose accordingly.

**ATTACHMENT A - EMPLOYMENT AND MATERIALS PREFERENCE FOR APPALACHIAN DEVELOPMENT HIGHWAY SYSTEM OR APPALACHIAN LOCAL ACCESS ROAD CONTRACTS**

This provision is applicable to all Federal-aid projects funded under the Appalachian Regional Development Act of 1965.

1. During the performance of this contract, the contractor undertaking to do work which is, or reasonably may be, done as on-site work, shall give preference to qualified persons who regularly reside in the labor area as designated by the DOL wherein the contract work is situated, or the subregion, or the Appalachian counties of the State wherein the contract work is situated, except:

a. To the extent that qualified persons regularly residing in the area are not available.

b. For the reasonable needs of the contractor to employ supervisory or specially experienced personnel necessary to assure an efficient execution of the contract work.

c. For the obligation of the contractor to offer employment to present or former employees as the result of a lawful collective bargaining contract, provided that the number of nonresident persons employed under this subparagraph (1c) shall not exceed 20 percent of the total number of employees employed by the contractor on the contract work, except as provided in subparagraph (4) below.

2. The contractor shall place a job order with the State Employment Service indicating (a) the classifications of the laborers, mechanics and other employees required to perform the contract work, (b) the number of employees required in each classification, (c) the date on which the participant estimates such employees will be required, and (d) any other pertinent information required by the State Employment Service to complete the job order form. The job order may be placed with the State Employment Service in writing or by telephone. If during the course of the contract work, the information submitted by the contractor in the original job order is substantially modified, the participant shall promptly notify the State Employment Service.

3. The contractor shall give full consideration to all qualified job applicants referred to him by the State Employment Service. The contractor is not required to grant employment to any job applicants who, in his opinion, are not qualified to perform the classification of work required.

4. If, within one week following the placing of a job order by the contractor with the State Employment Service, the State Employment Service is unable to refer any qualified job applicants to the contractor, or less than the number requested, the State Employment Service will forward a certificate to the contractor indicating the unavailability of applicants. Such certificate shall be made a part of the contractor's permanent project records. Upon receipt of this certificate, the contractor may employ persons who do not normally reside in the labor area to fill positions covered by the certificate, notwithstanding the provisions of subparagraph (1c) above.

5. The provisions of 23 CFR 633.207(e) allow the contracting agency to provide a contractual preference for the use of mineral resource materials native to the Appalachian region.

# STANDARD FEDERAL EQUAL EMPLOYMENT OPPORTUNITY CONSTRUCTION CONTRACT SPECIFICATIONS

## NOTICE OF REQUIREMENT FOR AFFIRMATIVE ACTION TO ENSURE EQUAL EMPLOYMENT OPPORTUNITY (EXECUTIVE ORDER 11246)

1. The Offeror's or Bidders attention is called to the "Equal Opportunity Clause" and the "Standard Federal Equal Employment Opportunity Construction Contract Specifications" set forth herein.
2. The goals and timetables for minority and female participation expressed in percentage terms for the Contractor's aggregate work force in each trade on all construction work in the covered area are as follows:

### Goals for Women Apply Nationwide

#### GOALS AND TIMETABLES

<i>Timetable</i>	<i>Goals (percent)</i>
From Apr. 1, 1976 until March 31, 1979-----	3.1
--	
From Apr. 1, 1979 until March 31, 1980-----	5.1
--	
From Apr. 1, 1980 until March 31, 1981-----	6.9
--	

### Goals for Minority Participation

South Carolina	
SMSA Counties:.....	16.0
Greenville, Pickens, Spartanburg	
Non-SMSA Counties:.....	17.8
Abbeville, Anderson, Cherokee, Greenwood, Laurens, Oconee, Union	
SMSA Counties:.....	23.4
Lexington, Richland	
Non-SMSA Counties.....	32.0
Calhoun, Clarendon, Fairfield, Kershaw, Lee, Newberry, Orangeburg, Saluda, Sumter	
Non-SMSA Counties.....	33.0
Chesterfield, Darlington, Dillon, Florence, Georgetown, Horry, Marion, Marlboro, Williamsburg	
SMSA Counties:.....	30.0
Berkeley, Charleston, Dorchester	
Non-SMSA Counties.....	30.7
Colleton	
Non-SMSA Counties.....	29.8
Beaufort, Hampton, Jasper	
Non-SMSA Counties.....	15.7
Chester Lancaster York	
Non-SMSA Counties.....	32.8
Barnwell, Edgefield, McCormick, Allendale, Bamberg	
SMSA Counties:.....	27.2
Aiken	

These goals are applicable to all the Contractor's construction work (whether or not it is Federal or federally assisted) performed in the covered area. If the Contractor performs construction work in a geographical area located outside of the covered area, it shall apply the goals established for such geographical areas where the work is actually performed. With regard to this second area, the Contractor is also subject to the goals for both its federally involved and nonfederally involved construction.

The Contractor's compliance with the Executive Order and the regulations in 41 CFR Part 60-4 Shall be based on its implementation of the Equal Opportunity Clause, specific affirmative action obligations required by the specifications set forth in 41 CFR 60-4.3(a) and its efforts to meet the goals established for the geographical area where the contract

resulting from this solicitation is to be performed. The hours of minority and female employment and training must be substantially uniform throughout the length of the contract, and in each trade, and the Contractor shall make a good faith effort to employ minorities and women evenly on each of its projects. The transfer of minority or female employees of trainees from Contractor to Contractor or from project to project for the sole purpose of meeting the Contractor's goals shall be a violation of the contract, the Executive Order and the regulations in 41 CFR Part 60-4. Compliance with the goals will be measured against the total work hours performed.

3. The Contractor shall provide written notification to the Director of the Office of Federal Contract Compliance Programs within 10 working days of award of any construction subcontract in excess of \$10,000 at any tier for construction work under the contract resulting from this solicitation. The notification shall list the name, address and telephone number of the subcontractor, employer identification number, estimated dollar amount of the subcontract; estimated starting and completion dates of the subcontract; and the geographical area in which the contract is to be performed.
4. As used in this Notice and in the contract resulting from this solicitation, the "covered area" is (insert description of the geographical areas where the contract is to be performed giving the state, county, and city, if any). The "covered area is the SMSA County or Counties or Non-SMSA County or Counties in which the contract work is performed.

## STANDARD FEDERAL EQUAL EMPLOYMENT OPPORTUNITY CONSTRUCTION CONTRACT SPECIFICATIONS (EXECUTIVE ORDER 11246)

1. As used in these specifications:
  - a. "Covered area" means the geographical area described in the solicitation from which this contract resulted;
  - b. "Director" means Director, Office of Federal Contract Compliance Programs, United States Department of Labor, or any person to whom the Director delegates authority;
  - c. "Employer identification number" means the Federal Social Security number used on the Employers Quarterly Federal Tax Return, U. S. Treasury Department Form 941.
  - d. "Minority" includes:
    - (i) Black (all persons having origins in any of the Black African racial groups not of Hispanic origin);
    - (ii) Hispanic (all persons of Mexican, Puerto Rican, Cuban, Central or South American or other Spanish Culture or origin regardless of race);
    - (iii) Asian or Pacific Islander (all persons having origins in any of the original peoples of the Far East, Southeast Asia, the Indian Subcontinent, or the Pacific Islands); and
    - (iv) American Indian or Alaskan Native (all persons having origins in any of the original peoples of North America and maintaining identifiable tribal affiliations through membership and participation or community identification).
2. Whenever the Contractor, or any Subcontractor at any tier, subcontracts a portion of the work involving any construction trade, it shall physically include in each subcontract in excess of \$10,000 the provisions of these specifications and the Notice which contains the applicable goals for minority and female participation and which is set forth in the solicitations from which this contract resulted.
3. If the Contractor is participating (pursuant to 41 CFR 60-4.5) in a Hometown Plan approved by the U. S. Department of Labor in the covered area either individually or through an association, its affirmative action obligations on all work in

- the Plan area (including goals and timetables) shall be in accordance with that Plan for those trades which have unions participating in the Plan. Contractors must be able to demonstrate their participation in and compliance with the provisions of any such Hometown Plan. Each Contractor or Subcontractor participating in an approved Plan is individually required to comply with its obligations under the EEO clause, and to make a good faith effort to achieve each goal under the Plan in each trade in which it has employees. The overall good faith performance by other Contractors or Subcontractors toward a goal in an approved Plan does not excuse any covered Contractor's or Subcontractor's failure to take good faith efforts to achieve the Plan goals and timetables.
4. The Contractor shall implement the specific affirmative action standards provided in paragraphs 7a through p of these specifications. The goals set forth in the solicitation from which this contract resulted are expressed as percentages of the total hours of employment and training of minority and female utilization the Contractor should reasonably be able to achieve in which it has employees in each construction trade in which it has employees in the covered area. Covered construction contractors performing construction work in geographical areas where they do not have a Federal or federally assisted construction contract shall apply the minority and female goals established for the geographical area where the work is being performed. Goals are published periodically in the Federal Register in notices form and such notices may be obtained from any Office of Federal Contract Compliance Programs office or from Federal procurement contracting officers. The Contractor is expected to make substantially uniform progress toward its goals in each craft during the period specified.
  5. Neither the provisions of any collective bargaining agreement, nor the failure by a union with whom the Contractor has a collective bargaining agreement to refer either minorities or women shall excuse the Contractor's obligations under these specifications, Executive Order 11246, or the regulations promulgated pursuant thereto.
  6. In order for the non-working training hours of apprentices and trainees to be counted in meeting the goals, such apprentices and trainees must be employed by the Contractor during the training period, and the Contractor must have made a commitment to employ the apprentices and trainees at the completion of their training, subject to the availability of employment opportunities. Trainees must be trained pursuant to training programs approved by the U. S. Department of Labor.
  7. The Contractor shall take specific affirmative actions to ensure equal employment opportunity. The evaluation of the Contractor's compliance with these specifications shall be based upon its effort to achieve maximum results from its actions. The Contractor shall document these efforts fully, and shall implement affirmative action steps at least as extensive as the following:
    - a. Ensure and maintain a working environment free of harassment, intimidation, and coercion at all sites, and in all facilities at which the Contractor's employees are assigned to work. The Contractor where possible, will assign two or more women to each construction project. The Contractor shall specifically ensure that all foremen, superintendents and other on-site supervisory personnel are aware of and carry out the Contractor's obligation to maintain such a working environment, with specific attention to minority of female individuals working at such sites or in such facilities.
    - b. Establish and maintain a current list of minority and female recruitment sources, provide written notification to minority recruitment sources and to community organizations when the Contractor or its unions have employment opportunities available and maintain a record of the organization's responses.
    - c. Maintain a current file of the names, addresses and telephone numbers of each minority and female off-the-street applicant and minority or female referral from a union, a recruitment source or community organization and of what action was taken with respect to each individual. If such individual was sent to the union hiring hall for referral and was not referred back to the Contractor by the union or, if referred, not employed by the Contractor, this shall be documented in the file with the reason therefor, along with whatever additional actions the Contractor may taken.
- d. Provide immediate written notification to the Director when union or unions with which the Contractor has a collective bargaining agreement has not referred to the Contractor a minority person or woman sent by the Contractor, or when the Contractor has other information that the union referral process has impeded the Contractor's efforts to meet his obligations.
  - e. Develop on-the-job training opportunities and/or participate in training programs for the area which expressly include minorities and women, including upgrading programs and apprenticeship and trainee programs relevant to the Contractor's employment needs, especially those programs funded by the Department of Labor. The Contractor shall provide notice of these programs to the sources compiled under 7b above.
  - f. Disseminate the Contractor's EEO policy to unions and training programs and requesting their cooperation in assisting the Contractor in meeting its EEO obligations; by including it in any policy manual and collective bargaining agreement; by publicizing it in the company newspaper, annual report, etc.; by specific review of the policy with all management personnel and with all minority and female employees at least once a year; and by posting the company EEO policy on bulletin boards accessible to all employees at each location where construction work is performed.
  - g. Review at least annually, the company's EEO policy and affirmative action obligations under these specifications with all employees having any responsibility for hiring, assignment, layoff, termination or other employment decisions including specific review of these items with on-site supervisory personnel such as Superintendents, General Foremen, etc., prior to the initialization of construction work at any job site. A written record shall be made and maintained identifying the time and place of these meetings, persons attending, subject matter discussed, and disposition of the subject matter.
  - h. Disseminate the Contractor's EEO policy externally by including it in any advertising in the news media, specifically including minority and female news media, and providing written notification to and discussing the Contractor's EEO policy with other Contractors and Subcontractors with whom the Contractor does or anticipates doing business.
  - i. Direct its recruitment efforts, both oral and written, to minority, female and community organizations, to schools with minority and female students and to minority and female recruitment and training organizations serving the Contractor's recruitment area and employment needs. Not later than one month prior to the date for the acceptance of applications for apprenticeship or other training by any recruitment source, the Contractor shall sent written notification to organizations such as the above, describing the openings, screening procedures and tests to be used in the selection process.
  - j. Encourage present minority and female employees to recruit other minority persons and women and where reasonable, provide after school, summer, and vacation employment to minority and female youth both on the site and in other areas of a Contractor's work force.
  - k. Validate all tests and other selection requirements where there is an obligation to do so under 41 CFR Part 60-3.
  - l. Conduct, at least annually, an inventory and evaluation at least of all minority and female personnel for promotional opportunities and encourage these employees to seek or to prepare for, through appropriate training, etc., such opportunities.
  - m. Ensure that all seniority practices, job classifications, work assignments and other personnel practices, do not have a discriminatory effect by continually monitoring all

- personnel and employment related activities to ensure that the EEO policy and the Contractor's obligations under these specifications are being carried out.
- n. Ensure that all facilities and company activities are non-segregated except that separate or single-user toilet and necessary changing facilities shall be provided to assure privacy between the sexes.
  - o. Document and maintain a record of all solicitations of offers for subcontracts from minority and female construction contractors and suppliers, including circulation of solicitations to minority and female contractor associations and other business associations.
  - p. Conduct a review, at least annually of all supervisors' adherence to and performance under the Contractor's EEO policies and affirmative action obligations.
8. Contractors are encouraged to participate in voluntary associations which assist in fulfilling one or more of their affirmative action obligations (7a through p). The efforts of a contractor association joint contractor-union, contractor-community, or other similar group of which the Contractor is a member and participant, may be asserted as fulfilling any one or more of its obligations under 7a through p of these specifications provided that the contractor actively participates in the group, makes every effort to assure that the group has a positive impact on the employment of minorities and women in the industry, ensures that the concrete benefits of the program are reflected in the contractor's minority and female work force participation, makes a good faith effort to meet its individual goals and timetables, and can provide access to documentation which demonstrates the effectiveness of actions taken on behalf of the Contractor. The obligation to comply, however, is the Contractor's and failure of such a group to fulfill an obligation shall not be a defense for the Contractor's noncompliance.
  9. A single goal for minorities and a separate single goal for women have been established. The Contractor, however, is required to provide equal employment opportunity and take affirmative action for all minority groups, both male and female, and all women, both minority and non-minority. Consequently, the Contractor may be in violation of the Executive Order if a particular group is employed in a substantially disparate manner (for example, even though the Contractor may be in violation of the Executive Order if a specific minority group of women is underutilized).
  10. The Contractor shall not use the goals and timetables or affirmative action standards to discriminate against any person because of race, color, religion, sex, or national origin.
  11. The Contractor shall not enter into any Subcontract with any person or firm debarred from the Government contracts pursuant to the executive Order 11246.
  12. The Contractor shall carry out such sanctions and penalties for violation of these specifications and the Equal Opportunity Clause, including suspensions, termination and cancellation of the existing subcontracts as may be imposed or ordered pursuant to Executive Order 11246, as amended. and its implementing regulations, by the Office if the Federal Compliance Programs. Any Contractor who fails to carry out such sanctions and penalties shall be in violation of the specifications and Executive Order 11246, as amended.
  13. The Contractor, in fulfilling its obligations under these specifications, shall implement specific affirmative action steps, at least as extensive as those standards prescribed in paragraph 7 of these specifications, so as to achieve maximum results from its efforts to ensure equal employment opportunity. If the Contractor fails to comply with the requirements of the executive Order, the implementing regulations, or these specifications, the Director shall proceed in accordance with 41 CFR 60-4-8.
  14. The Contractor shall designate a responsible official to monitor all employment related activity to ensure that the company EEO policy is being carried out, to submit reports relating to the provisions hereof as may be required by the Government and to keep records. Records shall at least include for each employee the name, address, telephone numbers, construction trade, union affiliation if any employee identification number when assigned, social security number, race, sex status(e.g., Mechanic, apprentice, trainee, helper, or laborer), dates of changes in status, hours worked per week in the indicated trade, rate of pay, and location at which the work was performed. Records shall be maintained in an easily understandable and retrievable form; however, to the degree that the existing records satisfy this requirement, contractors shall not be required to maintain separate records.
  15. Nothing herein provided shall be construed as a limitation upon the application of other laws which establish different standards of compliance or upon the application of requirements for the hiring of local or other area residents(e.g. those under the Public Works Employment Act of 1977 and the Community Development Block Grant Program).

**General Decision Number: SC140041 01/03/2014 SC41**

Superseded General Decision Number: SC20130041

State: South Carolina

Construction Type: Highway

Counties: Berkeley, Charleston, Dorchester and Horry Counties in South Carolina.

HIGHWAY CONSTRUCTION PROJECTS (excluding tunnels, building structures in rest area projects & railroad construction; bascule, suspension & spandrel arch bridges designed for commercial navigation, bridges involving marine construction; and other major bridges).

Modification Number      Publication Date  
0                              01/03/2014

SUSC2011-032 09/15/2011

	Rates	Fringes
CARPENTER (Form Work Only)		
Berkeley, Dorchester.....	\$ 13.50	
Charleston.....	\$ 13.07	
Horry.....	\$ 14.29	
CEMENT MASON/CONCRETE FINISHER		
Berkeley, Dorchester.....	\$ 14.79	
Charleston.....	\$ 14.33	
Horry.....	\$ 14.62	
IRONWORKER, REINFORCING.....	\$ 15.35	
LABORER		
Asphalt, Includes Asphalt Distributor, Raker, Shoveler, and Spreader Berkeley, Charleston, Dorchester.....	\$ 11.62	
Asphalt, Includes Asphalt Distributor, Shoveler and Spreader Horry.....	\$ 11.54	
Common or General		
Berkeley.....	\$ 10.06	
Charleston.....	\$ 10.16	
Dorchester.....	\$ 11.69	
Horry.....	\$ 9.72	
Luteman.....	\$ 11.61	
Mason Tender- Cement/Concrete.....	\$ 10.40	
Pipelayer.....	\$ 13.98	
Traffic Control-Cone Setter Berkeley, Charleston, Dorechester.....	\$ 13.19	

Horry.....\$ 12.63  
 Traffic Control-Flagger.....\$ 11.07

POWER EQUIPMENT OPERATOR:

Backhoe/Excavator/Trackhoe  
 Berkeley.....\$ 15.68  
 Charleston.....\$ 16.09  
 Dorchester.....\$ 16.06  
 Horry.....\$ 15.04  
 Bulldozer.....\$ 14.81  
 Crane  
 Berkeley, Dorchester.....\$ 20.00                      4.73  
 Charleston.....\$ 20.08  
 Horry.....\$ 20.58  
 Grader/Blade.....\$ 14.61  
 Hydroseeder.....\$ 11.00  
 Loader (Front End/Track)....\$ 16.80  
 Mechanic  
 Berkeley, Dorchester.....\$ 19.07  
 Charleston.....\$ 19.21  
 Horry.....\$ 19.48  
 Milling Machine.....\$ 11.84  
 Paver  
 Berkeley, Charleston,  
 Dorchester.....\$ 18.85  
 Horry.....\$ 13.29  
 Roller.....\$ 15.17  
 Scraper.....\$ 12.71  
 Screed.....\$ 13.56  
 Tractor.....\$ 13.28

TRUCK DRIVER

Dump Truck.....\$ 10.67  
 Lowboy Truck.....\$ 15.55

-----  
 WELDERS - Receive rate prescribed for craft performing  
 operation to which welding is incidental.

=====  
 Unlisted classifications needed for work not included within  
 the scope of the classifications listed may be added after  
 award only as provided in the labor standards contract clauses  
 (29CFR 5.5 (a) (1) (ii)).

-----  
 The body of each wage determination lists the classification  
 and wage rates that have been found to be prevailing for the  
 cited type(s) of construction in the area covered by the wage  
 determination. The classifications are listed in alphabetical  
 order of "identifiers" that indicate whether the particular  
 rate is union or non-union.

Union Identifiers

An identifier enclosed in dotted lines beginning with  
 characters other than "SU" denotes that the union  
 classification and rate have found to be prevailing for that  
 classification. Example: PLUM0198-005 07/01/2011. The  
 first four letters , PLUM, indicate the international union and  
 the four-digit number, 0198, that follows indicates the local



union number or district council number where applicable , i.e., Plumbers Local 0198. The next number, 005 in the example, is an internal number used in processing the wage determination. The date, 07/01/2011, following these characters is the effective date of the most current negotiated rate/collective bargaining agreement which would be July 1, 2011 in the above example.

Union prevailing wage rates will be updated to reflect any changes in the collective bargaining agreements governing the rate.

#### Non-Union Identifiers

Classifications listed under an "SU" identifier were derived from survey data by computing average rates and are not union rates; however, the data used in computing these rates may include both union and non-union data. Example: SULA2004-007 5/13/2010. SU indicates the rates are not union rates, LA indicates the State of Louisiana; 2004 is the year of the survey; and 007 is an internal number used in producing the wage determination. A 1993 or later date, 5/13/2010, indicates the classifications and rates under that identifier were issued as a General Wage Determination on that date.

Survey wage rates will remain in effect and will not change until a new survey is conducted.

---

#### WAGE DETERMINATION APPEALS PROCESS

1.) Has there been an initial decision in the matter? This can be:

- \* an existing published wage determination
- \* a survey underlying a wage determination
- \* a Wage and Hour Division letter setting forth a position on a wage determination matter
- \* a conformance (additional classification and rate) ruling

On survey related matters, initial contact, including requests for summaries of surveys, should be with the Wage and Hour Regional Office for the area in which the survey was conducted because those Regional Offices have responsibility for the Davis-Bacon survey program. If the response from this initial contact is not satisfactory, then the process described in 2.) and 3.) should be followed.

With regard to any other matter not yet ripe for the formal process described here, initial contact should be with the Branch of Construction Wage Determinations. Write to:

Branch of Construction Wage Determinations  
Wage and Hour Division  
U.S. Department of Labor  
200 Constitution Avenue, N.W.  
Washington, DC 20210

2.) If the answer to the question in 1.) is yes, then an interested party (those affected by the action) can request

review and reconsideration from the Wage and Hour Administrator (See 29 CFR Part 1.8 and 29 CFR Part 7). Write to:

Wage and Hour Administrator  
U.S. Department of Labor  
200 Constitution Avenue, N.W.  
Washington, DC 20210

The request should be accompanied by a full statement of the interested party's position and by any information (wage payment data, project description, area practice material, etc.) that the requestor considers relevant to the issue.

3.) If the decision of the Administrator is not favorable, an interested party may appeal directly to the Administrative Review Board (formerly the Wage Appeals Board). Write to:

Administrative Review Board  
U.S. Department of Labor  
200 Constitution Avenue, N.W.  
Washington, DC 20210

4.) All decisions by the Administrative Review Board are final.

=====



POWER EQUIPMENT OPERATOR:

Backhoe/Excavator/Trackhoe	
Allendale, Bamberg,	
Barnwell, Newberry,	
Orangeburg.....	\$ 17.56
Beaufort.....	\$ 15.20
Colleton.....	\$ 17.78
Georgetown, Hampton,	
Jasper, Williamsburg.....	\$ 17.23
Bulldozer.....	\$ 20.12
Crane.....	\$ 16.62
Grader/Blade.....	\$ 16.62
Loader (Front End).....	\$ 15.51
Mechanic.....	\$ 18.22
Milling Machine.....	\$ 18.83
Paver	
Allendale, Bamberg,	
Barnwell, Newberry,	
Orangeburg, Williamsburg...	\$ 15.01
Beaufort.....	\$ 14.96
Colleton, Georgetown,	
Hampton, Jasper.....	\$ 13.67
Roller.....	\$ 12.76
Screed.....	\$ 13.01
Tractor.....	\$ 13.26

TRUCK DRIVER

Dump Truck.....	\$ 12.00
Lowboy Truck.....	\$ 14.43
Single Axle, Includes	
Pilot Car.....	\$ 12.04
Tractor Haul Truck.....	\$ 16.25

-----

WELDERS - Receive rate prescribed for craft performing operation to which welding is incidental.

=====

Unlisted classifications needed for work not included within the scope of the classifications listed may be added after award only as provided in the labor standards contract clauses (29CFR 5.5 (a) (1) (ii)).

-----

The body of each wage determination lists the classification and wage rates that have been found to be prevailing for the cited type(s) of construction in the area covered by the wage determination. The classifications are listed in alphabetical order of "identifiers" that indicate whether the particular rate is union or non-union.

Union Identifiers

An identifier enclosed in dotted lines beginning with

characters other than "SU" denotes that the union classification and rate have found to be prevailing for that classification. Example: PLUM0198-005 07/01/2011. The first four letters , PLUM, indicate the international union and the four-digit number, 0198, that follows indicates the local union number or district council number where applicable , i.e., Plumbers Local 0198. The next number, 005 in the example, is an internal number used in processing the wage determination. The date, 07/01/2011, following these characters is the effective date of the most current negotiated rate/collective bargaining agreement which would be July 1, 2011 in the above example.

Union prevailing wage rates will be updated to reflect any changes in the collective bargaining agreements governing the rates.

0000/9999: weighted union wage rates will be published annually each January.

#### Non-Union Identifiers

Classifications listed under an "SU" identifier were derived from survey data by computing average rates and are not union rates; however, the data used in computing these rates may include both union and non-union data. Example: SULA2004-007 5/13/2010. SU indicates the rates are not union majority rates, LA indicates the State of Louisiana; 2004 is the year of the survey; and 007 is an internal number used in producing the wage determination. A 1993 or later date, 5/13/2010, indicates the classifications and rates under that identifier were issued as a General Wage Determination on that date.

Survey wage rates will remain in effect and will not change until a new survey is conducted.

---

#### WAGE DETERMINATION APPEALS PROCESS

1.) Has there been an initial decision in the matter? This can be:

- \* an existing published wage determination
- \* a survey underlying a wage determination
- \* a Wage and Hour Division letter setting forth a position on a wage determination matter
- \* a conformance (additional classification and rate) ruling

On survey related matters, initial contact, including requests for summaries of surveys, should be with the Wage and Hour Regional Office for the area in which the survey was conducted because those Regional Offices have responsibility for the Davis-Bacon survey program. If the response from this initial contact is not satisfactory, then the process described in 2.) and 3.) should be followed.

With regard to any other matter not yet ripe for the formal

process described here, initial contact should be with the Branch of Construction Wage Determinations. Write to:

Branch of Construction Wage Determinations  
Wage and Hour Division  
U.S. Department of Labor  
200 Constitution Avenue, N.W.  
Washington, DC 20210

2.) If the answer to the question in 1.) is yes, then an interested party (those affected by the action) can request review and reconsideration from the Wage and Hour Administrator (See 29 CFR Part 1.8 and 29 CFR Part 7). Write to:

Wage and Hour Administrator  
U.S. Department of Labor  
200 Constitution Avenue, N.W.  
Washington, DC 20210

The request should be accompanied by a full statement of the interested party's position and by any information (wage payment data, project description, area practice material, etc.) that the requestor considers relevant to the issue.

3.) If the decision of the Administrator is not favorable, an interested party may appeal directly to the Administrative Review Board (formerly the Wage Appeals Board). Write to:

Administrative Review Board  
U.S. Department of Labor  
200 Constitution Avenue, N.W.  
Washington, DC 20210

4.) All decisions by the Administrative Review Board are final.

=====

END OF GENERAL DECISION

**DISADVANTAGED BUSINESS ENTERPRISES (DBE)**  
**COMMITTAL SHEET**

Information must be shown on this sheet as required by the supplemental specifications entitled "Instructions to Bidders - Federal Projects" and "Disadvantaged Business Enterprises (DBE) - Federal Projects" included in this proposal.

**FAILURE TO PROVIDE ALL INFORMATION REQUIRED ON THIS FORM MAY RESULT IN THE AWARD BEING MADE TO THE NEXT LOWEST RESPONSIBLE BIDDER.**

<sup>1</sup> Name & Address of DBE's (Subcontractor or Supplier)	<sup>2</sup> Percent	<sup>3</sup> Description of Work and Approximate Quantity <sup>6</sup> (show percent when appropriate)				<sup>5</sup> Dollar Value
		Item	Qty.	Unit	<sup>4</sup> Unit Price	

- <sup>1</sup> The designation of Firm A and/or B is not considered acceptable. I hereby certify that this company has communicated with and received quotes from the DBE's listed above and that they are willing to perform the work as listed above and that this company is committed to utilizing the above firm(s) on this contract.
- <sup>2</sup> Percent - show percent of total contract amount committed to each DBE listed.
- <sup>3</sup> All information requested must be included unless item is listed in proposal on a lump sum basis.
- <sup>4</sup> Unit Price - show unit price quoted by DBE.
- <sup>5</sup> Dollar Value - extended amount based on Quantity and Unit Price.
- <sup>6</sup> Applies to lump sum items only.

This form may be reproduced or additional sheets added in order to provide all requested information. (See *Instructions to Bidders - Federal Projects*).

SWORN to before me this \_\_\_\_\_  
day of \_\_\_\_\_, 20\_\_\_\_\_

\_\_\_\_\_  
Company

\_\_\_\_\_  
(Seal)

By: \_\_\_\_\_

Notary Public for \_\_\_\_\_

Title: \_\_\_\_\_

My commission expires: \_\_\_\_\_

# **EXHIBIT 8**

## **ENVIRONMENTAL INFORMATION**



EXHIBIT 8 – ENVIRONMENTAL INFORMATION

Project Environmental Commitments

The following special commitments have been agreed to by the SCDOT:

Commitment	EA Reference Page
<p>1) SCDOT will employ the following avoidance measures regarding both the shortnose sturgeon (<i>Acipenser brevirostrum</i>) and the Atlantic sturgeon (<i>Acipenser oxyrinchus oxyrinchus</i>):</p> <p>A seasonal construction moratorium for all in-water work related to the bridge replacement project will be implemented for the period of January 1 through April 15. In-water work is defined as any activity (e.g. excavation, fill, pile driving, drilled shaft construction) that could result in the physical destruction or alteration of important spawning habitats. During the moratorium, the contractor would be allowed to work from a barge in order to construct columns, caps, and bridge superstructure. The contractor would be allowed to move barges between shafts during the moratorium; however, barges must be secured by cables as placement of spuds to secure barges will not be allowed during the moratorium. Equipment and materials used during the construction of the bridge will not obstruct or impede passage through more than 50 percent of the channel. This restriction will allow the migratory pathway to remain open while both shortnose sturgeon and Atlantic sturgeon are likely to be migrating.</p>	<p>Page 31. <i>Interpretation for CONTRACTOR: the CONTRACTOR shall comply with these avoidance measures regarding both the shortnose sturgeon and the Atlantic sturgeon within the normal banks of the Great Pee Dee River.</i></p>
<p>2) Standard sediment control measures will be implemented by the contractor.</p>	<p>Page 32. <i>Stormwater control measures, both during construction and post-construction, are required for SCDOT projects constructed in the vicinity of 303(d), TMDL, ORW, tidal, and shellfish beds in accordance with the SCDOT's MS4 Permit.</i></p>
<p>3) The stipulations outlined in the Memorandum of Agreement (MOA) between the Department, the State Historic Preservation Office (SHPO), the Federal Highway Administration (FHWA), the United States Fish and Wildlife Service (USFWS), and the Catawba Indian Nation Tribal Historic Preservation Officer (CIN-THPO), dated 6/20/2012 will be implemented by the Department. They are:</p>	<p>Appendix B, Pages 124 -128. <i>Interpretation for CONTRACTOR: the CONTRACTOR shall comply with this commitment, but SCDOT shall provide the archeologist for 3)c. The CONTRACTOR shall include coordination with SCDOT in its Environmental Plan and shall notify SCDOT at least 72 hours prior to any work related to this commitment.</i></p>

Commitment	EA Reference Page
<p>a) The southern bridge approach has substantially impacted a small portion of 38GE18. The project’s “area of potential effect” will be limited to this area. To protect the adjacent intact portion of 38GE18, the FHWA and SCDOT will ensure that the boundaries of archaeological site 38GE18 are identified as a “Restricted Area” on all construction plans. The construction plans will include the following notation, “no ground-disturbing activities, including construction, heavy equipment access, and storage for equipment and materials are allowed within the Restricted Area.” SCDOT will also inform the selected contractor about these restrictions at the Pre-Construction meeting where all special provisions are discussed.</p> <p>b) SCDOT’s contractor will erect orange tree-saving fencing at the edge of the project’s construction limits within the boundaries of archaeological site 38GE18 to clearly indicate the location of the “Restricted Area” as shown on the construction plans.</p> <p>c) All construction activities within the boundaries of archaeological site 38GE18 will be monitored by a professional archaeologist who meets the Secretary of the Interior’s Professional Qualification Standards for Archaeology. (48 FR 44738-39).</p> <p>SCDOT will provide the FHWA, the USFWS, the SHPO, and the CIN-THPO with a written report that describes the results of monitoring activities.</p> <p>All work within the boundaries of archaeological site 38GE18 will cease immediately if unanticipated cultural materials or human skeletal remains are discovered during construction monitoring activities. SCDOT will immediately inform the USFWS, the FHWA, the SHPO and the CIN-THPO about the late discovery.</p>	

EXHIBIT 8 – ENVIRONMENTAL INFORMATION

Commitment	EA Reference Page
4) The stipulations outlined in the letter to Horry County, dated October 22, 2012, regarding the Horry County public boat landing will be implemented by the Department. With the selection of the preferred alternative, the boat landing will be removed and relocated. But at times that are safe and practical, SCDOT maintains its previous commitment of keeping the existing or the relocated boat ramp accessible during construction.	Appendix B, Page B-113. <i>Interpretation for CONTRACTOR: the CONTRACTOR shall comply with the stipulations outlined in the letter to Horry County dated October 22, 2012. The CONTRACTOR shall coordinate with Horry County and SCDNR as noted in EXHIBIT 4a.</i>
5) The general conditions and specifications for an Individual Permit from the Corps of Engineers for wetland encroachment will be implemented. The permit will be obtained by the Department.	Page 40. <i>Interpretation for CONTRACTOR: the CONTRACTOR shall obtain and comply with the Individual Permit from the Corps of Engineers for wetland encroachment.</i>
6) The Contractor will utilize 2:1 slopes in wetland areas where appropriate, and reclamation of wetland areas temporarily lost through construction activities will involve returning disturbed areas to their original elevations to the extent practicable, allowing for adjacent vegetation to naturally reclaim the area.	Page 37. <i>Interpretation for CONTRACTOR: the CONTRACTOR at its own discretion may utilize steeper slopes to further minimize wetland impacts.</i>
7) To mitigate for unavoidable wetland impacts, SCDOT will follow the Corps of Engineers SOPs to locate and acquire an appropriate property that will generate the compensatory mitigation credits required to compensate for unavoidable impacts associated with the proposed bridge replacements.	Page 37. <i>Interpretation for CONTRACTOR: SCDOT will provide up to 219 wetland mitigation credits at no cost to CONTRACTOR. CONTRACTOR shall be responsible for any additional <del>at</del> mitigation costs.</i>
8) SCDOT will comply with the intent of Presidential Executive Order on Invasive Species 13112, of February 3, 1999, by formulating a plan to actively re-plant native vegetation for all temporarily disturbed areas. The plan will include planting fast growing, locally native plant species to minimize the potential for establishment of aggressive, invasive species.	Page 38. <i>Interpretation for CONTRACTOR: the CONTRACTOR shall coordinate with the SCDOT's Environmental Service's Division and the Waccamaw National Wildlife Refuge to prepare and follow a plan that ensures compliance.</i>
9) Coast Guard permit will be obtained	Page 40. <i>Interpretation for CONTRACTOR: The CONTRACTOR shall obtain and comply with the United States Coast Guard Bridge Permit.</i>

EXHIBIT 8 – ENVIRONMENTAL INFORMATION

Commitment	EA Reference Page
10) Asbestos containing materials may be present in buildings in the project corridor, therefore surveys of any buildings to be demolished will be conducted as required by SCDHEC and materials should be handled in accordance with state and federal regulations.	
11) If avoidance of Underground Storage Tanks (USTs) is not a viable alternative, tanks and other hazardous materials will be tested and removed and/or treated in accordance with the U.S. Environmental Protection Agency (EPA) and South Carolina Department of Health and Environmental Control (SCDHEC) requirements. Costs necessary for cleanup would be taken into consideration during the right of way appraisal and acquisition process. The Department will test the UST sites along the project corridor for potential contamination before construction begins.	Page 55. <i>Interpretation for CONTRACTOR: A Phase I ESA has been completed along the project corridor. No other testing and/or cleanup has occurred. Further testing and/or cleanup shall be performed in accordance with the Agreement. The CONTRACTOR shall perform necessary testing and/or cleanup of USTs as necessary.</i>
12) The Department will comply with the Migratory Bird Treaty Act of 1918 in regard to the avoidance of taking of individual migratory birds and the destruction of their active nests. Prior to construction/demolition of the bridges the district personnel/contractor will coordinate with SCDOT Environmental Management Office to determine if there are any active nests on the bridge. After this coordination, it will be determined whether construction/demolition can begin. After construction/demolition has begun, measures can be taken to prevent birds from nesting, such as netting, noise producers, and etc. If during construction or demolition a nest is observed on the bridge that was not discovered during the biological surveys, the contractor will cease work and immediately notify the SCDOT Environmental Management Office. SCDOT biologists will determine whether the nest is active and the species utilizing the nest. After this coordination, it will be determined whether construction/demolition can resume or whether a temporary moratorium will be put into effect.	Page 46. <i>Interpretation for CONTRACTOR: The CONTRACTOR shall comply with the Migratory Bird Treaty Act and coordinate with SCDOT's Environmental Services Division with respect to this compliance.</i>
13) If existing bridge demolition activities are expected to occur in late fall to early winter, which is the typical maternal roosting period of the Rafinesque's big-eared bat ( <i>Corynorhinus rafinesquii</i> ), prior to performing demolition work during this period, the district personnel/contractor will coordinate with SCDOT Environmental Management Office to prepare an appropriate plan to minimize interference with maternal roosting. Such a plan could include temporary moratoriums that limit certain activities	Page 45. <i>Interpretation for CONTRACTOR: The CONTRACTOR shall prepare a plan for and shall minimize interference with the Rafinesque's big-eared bat.</i>

EXHIBIT 8 – ENVIRONMENTAL INFORMATION

Commitment	EA Reference Page
<p>and/or methods to prevent roosting, such as netting or other physical barriers. The plan would also contain provisions for monitoring for maternal roosting activities, see Page 45.</p>	
<p>14) In order to mitigate for impacts to the Waccamaw National Wildlife Refuge, as detailed on Page 59, SCDOT commits to:</p> <ul style="list-style-type: none"> <li>a) Construct a southbound left turn lane at the Visitors' Center access drive.</li> <li>b) Relocate and reconstruct the Visitors' Center access drive as necessary to maintain safe access.</li> <li>c) Provide appropriate payment for purchasing property to mitigate the right of way acquisition from the Refuge</li> </ul>	<p>Page 59. Interpretation for CONTRACTOR: <i>In regards to the Refuge, the CONTRACTOR shall closely coordinate all efforts with SCDOT. The CONTRACTOR shall construct a new southbound left turn lane at the Visitors' Center access drive and, if needed, shall relocate and reconstruct the Visitors' Center access drive to maintain safe access. The CONTRACTOR's responsibility associated with Commitment 14c shall be as stipulated in Exhibit 3, Scope of Work. <del>shall prepare a technical memorandum that provides appropriate certification for the value of replacement property which includes but is not limited to real estate appraisals and natural resources assessments of similar properties. The CONTRACTOR shall be responsible for coordinating with the Refuge to ensure that Section 4(f) requirements are satisfied. Based on this certification, SCDOT shall provide compensation to the Refuge.</del></i></p>

**CONTRACTOR should be aware that all permitting should be coordinated through SCDOT's Environmental Services Division.**

# **EXHIBIT 9**

## **ESCROW PROPOSAL DOCUMENTS**

## Procedure to Escrow Bid Documentation by Delivery Service

The following is the procedure by which a Contractor may elect to use a delivery service to escrow bid documentation as required by the contract special provision in SCDOT contracts entitled: Escrow Bid Documentation, dated July 17, 1995. To successfully carry out this procedure, it is extremely important that each step be followed precisely. To preserve the chain of custody of the sealed bid documents, a delivery service with a tracking system such as Fed Ex, UPS, or DHL must be used. The person who signs the escrow agreement must be a person that has the authority to sign an agreement on behalf of the Contractor.

1. To initiate the process, SCDOT Contract Administration office will:
  - a. Prepare and send to the Contractor, three (3) copies of the Escrow Agreement for Contract Bid Documents and one (1) copy of the Affidavit.
  - b. Inform the Contractor and the U.S. Bank Corporate Trust Group that the escrow process has been initiated.
2. Upon receipt of the three (3) copies of the Escrow Agreement and copy of the Affidavit, the Contractor shall:
  - a. Fill in the date the bid document container is sealed on the page 1 and page 4 of each of the three (3) copies of the Escrow Agreement.
  - b. At the bottom of page 3 of the Escrow Agreement, print the signers name, sign, and witness all three (3) copies of the Agreement.
  - c. Complete, sign, and notarize the Affidavit.
  - d. Make two copies of the notarized Affidavit, one for the Contractor and one to send with the three (3) Agreements.
  - e. After making any copies of the contract bid documents and the Affidavit, place the contract bid documents and the original of the Affidavit in a suitable document container, such as a tear-resistant Tyvek envelope.
  - f. **DO NOT** put a three-ring binder or any other metal binding devices in the bid document container.
  - g. On the front of the bid document container, print the following information:
    - Contractor's Name
    - SC File No(s).
    - Date that the bid document container was sealed
  - h. Seal the contract bid document container by wrapping clear tape in a continuous line at least once lengthwise and once widthwise around the container. Sign your name across each line of tape, so that part of the signature is partially on the tape and partially on the container. Use a ballpoint pen to sign because ink from other types of pens can generally be wiped off of the tape.

- i. Place the sealed contract bid document container, the three (3) signed Agreements, and a copy of the Affidavit into a second outer container labeled with the following instructions prominently visible:

ESCROW DOCUMENTS  
TO BE OPENED ONLY BY  
NATALIE McNAIR  
CORPORATE TRUST GROUP
  - j. Place the second outer container into a delivery service shipping container.
  - k. Send the shipping container via delivery service, such as Fed Ex, UPS, or DHL, addressed as follows:

Natalie McNair - Escrow Documents  
U.S. Bank - Corporate Trust Group  
1441 Main Street, Suite 775  
Columbia, SC 29201  
Phone 803-212-7905
  - l. Immediately after the package is given to the delivery service, call the SCDOT Contracts Administration Office (803) 737-1434 and provide the tracking number.
3. After accepting delivery of the package containing the three (3) copies of the Escrow Agreement, original copy of the Affidavit, and sealed bid document container, Natalie McNair of the U.S. Bank will:
    - a. Take possession of the sealed bid document container and sign across the sealing tape.
    - b. Sign and witness the three (3) copies of the Escrow Agreement.
    - c. Send the three (3) copies of the Agreement and the copy of the Affidavit to the SCDOT Contracts Administration office in the headquarters building in Columbia.
  4. Upon receipt of the three (3) copies of the escrow agreement and the copy of the Affidavit, the SCDOT Contract Administration office will:
    - a. Sign and witness the three (3) Escrow Agreements.
    - b. Send a fully executed copy Escrow Agreement to the Contractor.
    - c. Send fully executed copy Escrow Agreement to U.S. Bank

If you have any questions about the steps in this procedure, please call the SCDOT Contracts Administration office at (803) 737-1434. It is extremely **IMPORTANT** to follow the steps prescribed above.

G. A. Peck  
Contracts Engineer  
803-737-1434



**SAMPLE ESCROW AGREEMENT  
SCDOT CONTRACT ADMINISTRATION WILL PROVIDE AGREEMENT FOR SIGNATURES**

**ESCROW AGREEMENT  
FOR  
CONTRACT BID DOCUMENTS**

THIS AGREEMENT is made and entered into this **Day** day of **Month, Year**, by and among the South Carolina Department of Transportation, an agency of the State of South Carolina, hereinafter called the "DEPARTMENT", and **Contractor's Name**, hereinafter called the "CONTRACTOR", and **Bank's Name**, hereinafter called the "ESCROW AGENT".

WHEREAS, the DEPARTMENT and the CONTRACTOR desire to enter into a Construction Contract for work in SC File No(s). **Project File No(s)**, hereinafter called the "CONTRACT", pursuant to which the CONTRACTOR shall cause the work therein to be constructed; and

WHEREAS, the DEPARTMENT and CONTRACTOR desire to enter into an Escrow Agreement, to provide for specific contingencies governing the escrow and control of Contract bid documentation; hereinafter called "BID DOCUMENTS"; and

WHEREAS, the DEPARTMENT and CONTRACTOR desire the ESCROW AGENT to hold the BID DOCUMENTS of the CONTRACTOR;

NOW, THEREFORE, for and in consideration of the mutual covenants contained herein, it is agreed by and between the parties hereto that:

ARTICLE I  
ESCROW OF THE CONTRACT BID DOCUMENTATION

The parties hereto agree to the establishment of Escrow of the BID DOCUMENTS for the CONTRACT pursuant to the DEPARTMENT'S Standard Specifications for Highway Construction (Edition of 2007), and Supplemental Specifications or Special Provisions pertaining to construction under the CONTRACT. It is the understanding of the parties hereto that the DEPARTMENT shall pay the ESCROW AGENT, as determined by separate Agreement, for the escrow of the BID DOCUMENTS submitted to the ESCROW AGENT under the terms of this Agreement.

ARTICLE II  
ACKNOWLEDGEMENT

By its signature below, the ESCROW AGENT hereby acknowledges receipt from the DEPARTMENT and CONTRACTOR of a sealed container bearing the CONTRACTOR's name, address, and CONTRACT File Number(s) assigned by the DEPARTMENT and containing the CONTRACT BID DOCUMENTS.

ARTICLE III  
DEPOSIT OF BID DOCUMENTS

The CONTRACT BID DOCUMENTS shall remain on deposit with the ESCROW AGENT until those conditions of release, as specified in ARTICLE IV "RELEASE FROM ESCROW", are met. As long as the BID DOCUMENTS remain in escrow with the ESCROW AGENT, the ESCROW AGENT shall not allow any person access, to gain possession, or in any way to interfere with the sealed BID DOCUMENT container.

ARTICLE IV  
RELEASE FROM ESCROW

Upon being presented with documentation from the DEPARTMENT, signed by the Contract Administrator, that the Final Estimate for the CONTRACT has been paid to the CONTRACTOR, the ESCROW AGENT shall deliver to the CONTRACTOR the sealed container bearing the CONTRACTOR's name and address and File Number(s) on it. The ESCROW AGENT is also authorized to release the CONTRACT BID DOCUMENT sealed container to the DEPARTMENT without the CONTRACTOR's signed consent subject to written documentation, signed by the DEPARTMENT's Contract Administrator, that one or both of the following conditions have occurred:

1. The CONTRACTOR has filed a claim against the DEPARTMENT related to the project.
2. The CONTRACTOR has initiated litigation against the DEPARTMENT relating to the CONTRACT.

Prior to any release from escrow to the DEPARTMENT, the ESCROW AGENT shall provide written notice to the CONTRACTOR of the ESCROW AGENT's intention to release the CONTRACT BID DOCUMENTS sealed container to the DEPARTMENT. Such written notice from the ESCROW AGENT shall be sent by certified mail no less than ten (10) calendar days prior to release of the CONTRACT BID DOCUMENTS sealed container to the DEPARTMENT. Upon any release from escrow of the CONTRACT BID DOCUMENT sealed container, the party receiving the sealed container shall sign Exhibit A, ESCROW RELEASE FOR CONTRACT BID DOCUMENTS, as attached hereto and incorporated herein as if fully contained, by the party receiving the BID DOCUMENT container.

ARTICLE V  
INDEMNITY

The CONTRACTOR agrees to indemnify and hold the ESCROW AGENT harmless against any loss, claim, damage, liability or expenses incurred in connection with any action, suit, proceeding, claim or alleged liability arising from this Escrow Agreement, provided, however, that the ESCROW AGENT shall not be so indemnified or held harmless for its negligence or acts of bad faith by it or any of its agents or employees.

ARTICLE VI  
NOTICES

All notices and other communication shall be in writing and shall be deemed to have been duly given and delivered if mailed by certified mail, return receipt requested, postage prepaid to the addresses stated herein:

DEPARTMENT:

Contract Administration, Room No.: **No.**  
South Carolina Department of Transportation  
955 Park Street  
Columbia, SC 29201

CONTRACTOR:

**Company Name**  
**Street Address**  
**City/Town, State** **Zip Code**

ESCROW AGENT:

**Bank Name**  
**Street Address**  
**City/Town, State** **Zip Code**

ARTICLE VII  
DUTIES OF ESCROW AGENT

The duties and responsibilities of the ESCROW AGENT shall be limited to those expressly set forth herein and the ESCROW AGENT shall act only in accordance with this ESCROW Agreement. Notwithstanding specific provisions hereunder, the ESCROW AGENT shall at all times act upon and in accordance with the joint written instructions of the DEPARTMENT and CONTRACTOR.

ARTICLE VIII  
LAWS

This Escrow Agreement shall be deemed to have been executed in RICHLAND County, South Carolina and the laws of the State of South Carolina shall apply.

ARTICLE IX  
ASSIGNMENT

This Escrow Agreement shall not be assigned without the written consent of all the parties hereto.

ARTICLE X  
SURVIVAL OF CONTRACT

Except as may be expressly modified, all terms and conditions of this Escrow Agreement remain in full force and effect. The establishment of this Escrow Agreement is limited solely by the contingency of release of the CONTRACT BID DOCUMENTS sealed container by the CONTRACTOR to the DEPARTMENT, as established by ARTICLE IV, RELEASE FROM ESCROW. Nothing contained herein shall alter the rights of the parties hereto.

The covenants herein contained shall, except as otherwise provided, accrue to the benefit of and be binding upon the successors and assigns of the parties hereto.

IN WITNESS WHEREOF, the parties have hereunto set their hands and seals the day above first written.

CONTRACTOR  
**Company Name**  
**Representative's Name**

ESCROW AGENT  
**Bank Name**  
**Trust Officer's Name**

By: Representative's Signature (Seal)

By: Trust Officer's Signature (Seal)

Witness's Signature  
**Witness**

Witness's Signature  
**Witness**

DEPARTMENT  
**Department Representative**

By: Representative's Signature  
Representative's Title

Witness's Signature  
**Witness**

Exhibit A

**ESCROW RELEASE  
FOR  
CONTRACT BID DOCUMENTS**

This is to certify that on this Day day of Month, Year, the sealed container holding the BID DOCUMENTS for the following CONTRACT was release from escrow:

SC File No(s): Project File No(s).

CONTRACTOR: Company Name

Address: Street Address  
City/Town, State Zip Code

Date BID DOCUMENTS put into Escrow: Agreement Date

The Representative for the ESCROW AGENT identified below, personally transferred the sealed container holding the BID DOCUMENTS to the Representative for the CONTRACTOR or the DEPARTMENT.

**Acknowledgment of Release:**

\_\_\_\_\_  
(Print Name)

\_\_\_\_\_  
*Signature of Representative for U. S. Bank*

The individual named below acknowledges receipt of the sealed container holding the BID DOCUMENTS.

**Acknowledgment of Receipt:**

\_\_\_\_\_  
(Print Name)

\_\_\_\_\_  
Signature of Representative for \_\_\_\_\_  
Contractor Name

If the CONTRACTOR receives the sealed container holding the BID DOCUMENTS, the ESCROW AGENT will send a signed copy of this document to the DEPARTMENT.